

Panasonic®

Operating Instructions

4K Video Camera

Model No. **HC-X1000**

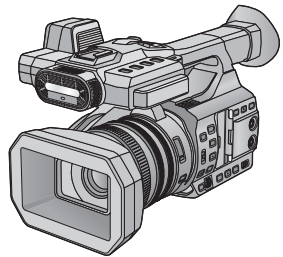

Please read these instructions carefully before using this product, and save this manual for future use.

AVCHD™
Progressive

HDMI

SD™ U3
XC I

DOLBY
DIGITAL

LEICA
DICOMAR

WiFi®
CERTIFIED



SQW0069

Read this first

■ About the recording method for recording motion pictures

This unit can record motion pictures using four different recording methods, including MOV (LPCM), MP4 (LPCM), MP4 and AVCHD*1.

(→ 31, 139)

*1 AVCHD Progressive (1080/50p, 1080/60p) supported.

MOV (LPCM)*2, MP4 (LPCM)*2, 3:

This recording method is suitable for editing images. Audio is recorded in linear PCM.

MP4*2, 3:

This recording method is suitable for playback and editing on a PC. Audio is recorded in AAC.

*2 Those methods are not compatible with motion pictures recorded in AVCHD format.

*3 Those methods can record motion pictures in formats that support 4K. 4K motion pictures offer a resolution four times higher than that of full high-definition motion pictures.

AVCHD:

This recording method is suitable for playback on a high-definition TV or storage on a disc. Audio is recorded in Dolby® Digital.

■ Regarding system frequencies

The NTSC/PAL standard setting of this unit can be switched in [SYSTEM FREQ]. (→ 159)

- To use this unit in regions where the TV broadcasting system is NTSC, set it to [59.94Hz(NTSC)]. To use this unit in regions where the TV broadcasting system is PAL, set it to [50Hz(PAL)]. (Playback is not possible on TVs and other devices with a standard that differs from the system frequency setting of this unit.)
- You cannot store AVCHD scenes recorded with different system frequencies on the same SD card. If you have switched the system frequency, use another SD card.

■ Indemnity about recorded content

Panasonic does not accept any responsibility for damages directly or indirectly due to any type of problems that result in loss of recording or edited content, and does not guarantee any content if recording or editing does not work properly. Likewise, the above also applies in a case where any type of repair is made to the unit.

■ About Condensation (When the lens, the viewfinder or LCD Monitor is fogged up)

Condensation occurs when there is a change in temperature or humidity, such as when the unit is taken from outside or a cold room to a warm room. Please be careful, as it may cause the lens, the viewfinder or LCD monitor to become soiled, moldy, or damaged.

When taking the unit to a place which has a different temperature, if the unit is accustomed to the room temperature of the destination for about one hour, condensation can be prevented. (When the difference in temperature is severe, place the unit in a plastic bag or the like, remove air from the bag, and seal the bag.) When condensation has occurred, remove the battery and/or the AC adaptor and leave the unit like that for about one hour. When the unit becomes accustomed to the surrounding temperature, fogginess will disappear naturally.

■ About security

Be careful about the possibility of theft or loss of the unit, and be careful not to leave the unit unattended. Please note that Panasonic does not accept any responsibility for the compromise, manipulation, and loss of information caused by these events.

■ Caution regarding laser beams



The lens may suffer damage if struck by a laser beam. Make sure that laser beams do not strike the lens when shooting in an environment where laser devices are used.

■ Cards that you can use with this unit

SDHC Memory Card and SDXC Memory Card

- 4 GB or more Memory Cards that do not have the SDHC logo or 48 GB or more Memory Cards that do not have the SDXC logo are not based on SD Memory Card Specifications.
- Refer to page 20 for more details on SD cards.

■ For the purposes of these operating instructions

- The battery pack is referred to as the "Battery".
- SDHC Memory Card and SDXC Memory Card are referred to as the "SD card".
- The smartphone and tablet are indicated as "smartphone".
- Function that can be used for Recording Mode: 
Function that can be used for Playback Mode: 
- Scene(s) recorded with [REC MODE] set to [MOV(LPCM)], [MP4(LPCM)] or [MP4]: "MOV/MP4 scene(s)".
- Scene(s) recorded with [REC MODE] set to [AVCHD]: "AVCHD scene(s)".
- Pages for reference are indicated by an arrow, for example: → 00

Contents

Read this first	2
-----------------------	---

Preparation

Names and Functions of Main Parts	6
Power supply	14
Charging the battery	14
Inserting/removing the battery	15
Charging and recording time	16
Connecting to the AC outlet.....	19
Preparation of SD cards	20
Cards that you can use with this unit	20
Inserting/removing an SD card	21
Turning the unit on/off	22
Selecting a mode	22
Using the LCD monitor/Viewfinder	23
Using the LCD monitor	23
How to use the touch screen	24
LCD monitor adjustment	24
Viewfinder adjustment	25
Recording yourself	26
Setting date and time	27
Using the menu screen	28

Recording

Before recording	29
Formatting media	30
Selecting a media to record	30
Recording motion pictures	31
Recording still pictures	32
Intelligent Auto Mode/Manual Mode.....	34
Intelligent Auto Plus	36
Using the zoom	37
Ring zoom	37
Image Stabilizer Function	38
Focus	39
Push AF	40
Focus Assist	40
Focus Transition	43
White Balance	46
Iris/Gain adjustment	48
Iris adjustment	48
Gain adjustment	49
Manual shutter speed	51
Audio Input	53
Switching Audio Input	53
Adjusting the audio input level.....	55

Counter display	57
Setting the Time Code	58
Setting the User Information	59
Setting the Recording Counter.....	60
USER button	61
Setting the USER button	61
Using the USER button	62
Functions of the USER button	63
Useful functions	72
Colour Bar Screen	72
ND filter	73
Zebra.....	74
Switching the screen indications/ mode information display	74
Using Operation Icons	75
Using of multi-function dial.....	76

Playback

Motion picture/Still picture playback	79
Motion picture playback using operation icon	83
Useful functions	85
Creating still picture from motion picture	85
Repeat Playback.....	85
Resuming the previous playback	86
Playing back scenes or still pictures by date	86
Deleting scenes/still pictures.....	87
Protecting scenes/still pictures.....	88
Watching Video/Pictures on your TV	89
Connecting with a HDMI cable.....	92

With a PC

Using this unit with a PC	93
What you can do with a PC	93
Connecting to a PC	93
Using this unit as a card reader.....	94
Using HD Writer XE 2.0	97

Copy/Dubbing

Copying/playing back with a USB HDD	102
Preparing for copying/playing back	102
Simple copy	105
Copy selected files	105
Playing back the External Drive.....	106
Dubbing with a Blu-ray disc recorder, video device, etc.	107

Wi-Fi

Wi-Fi® function	111
Remote operation	113
Preparations before using remote operation.....	113
Using remote operation with a direct connection	115
Using remote operation with a wireless access point connection	116
About remote operation	118
Install the “Image App”	119
Setting Up a Wi-Fi Connection	120
Using the Network Easy Setup to set up a connection	120
Connecting to a wireless access point.....	122
Setting up a direct connection to a smartphone.....	125
If the Wi-Fi connection cannot be established	127
How to Use the [Wi-Fi Setup] Menu	129

Menu

Using the Menu	132
Camera Setup.....	132
Recording Setup	139
TC/UB SETUP	150
Switch setting.....	151
Display setting.....	153
AV output setting.....	157
Other Functions	158
Wi-Fi setting	161
Video Setup	163
Picture Setup	163

Display

Indications	164
Messages	167
About recovery.....	167

Others

Troubleshooting	168
Cautions for use	172
About copyright	176
Recording modes/approximate recordable time	177
Approximate number of recordable pictures	179

Names and Functions of Main Parts

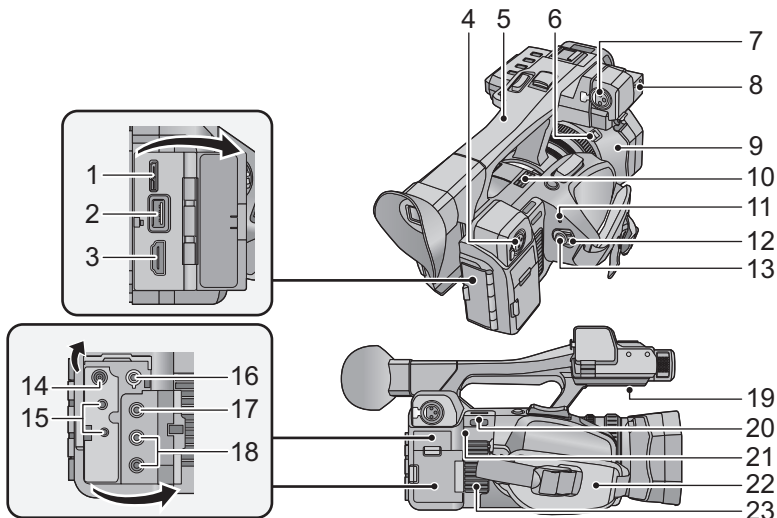

- 1 USB terminal [USB 3.0 DEVICE] (→ 93, 108)
 - 2 USB terminal [USB 3.0 HOST] (→ 102)
 - 3 HDMI connector [HDMI] (→ 89)
 - 4 Audio input terminals 2 (XLR 3 pin) [AUDIO INPUT2] (→ 13, 54)
 - 5 Handle
 - 6 Lens hood release button (→ 10)
 - 7 Audio input terminals 1 (XLR 3 pin) [AUDIO INPUT1] (→ 13, 54)
 - 8 Microphone holder attachment part (→ 12)
 - 9 Lens hood (→ 10)
 - 10 Exhaust opening (cooling fan) (→ 30)
 - 11 Status indicator (→ 22)
 - 12 Power switch (→ 22)
 - 13 Recording start/stop button (→ 31)
 - 14 DC input terminal [DC IN] (→ 19)
- Do not use any other AC adaptors except the supplied one.
- 15 Camera remote jack [CAM REMOTE] (3.5 mm mini jack)
- It is possible to adjust the focus or iris by connecting a remote control (commercially-available).

- It is not possible to use the remote control (commercially-available) in the Intelligent Auto Mode.

[ZOOM S/S] (2.5 mm super mini jack)

It is possible to operate zoom operation or recording start/stop connecting with the remote control (commercially-available).

- Do not connect any equipment except the remote control (commercially-available) to the camera remote jack. Brightness of the image may change or it may not focus when an equipment other than the remote control (commercially-available) is connected.

- 16 Headphone terminal [] (→ 78)
- 17 Video output connector [VIDEO OUT] (→ 89, 110)
- 18 Audio output connector [AUDIO OUT] (→ 89, 110)
- 19 Speaker
- 20 Shoulder strap fixture (→ 12)
- 21 Wi-Fi Transmitter (→ 112)
- 22 Grip belt (→ 11)
- 23 Inlet (cooling fan) (→ 30)

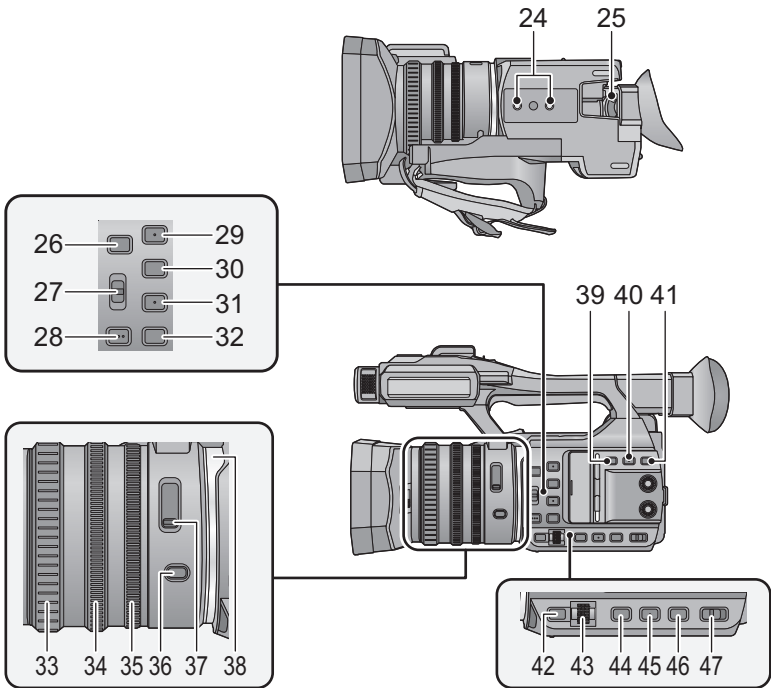

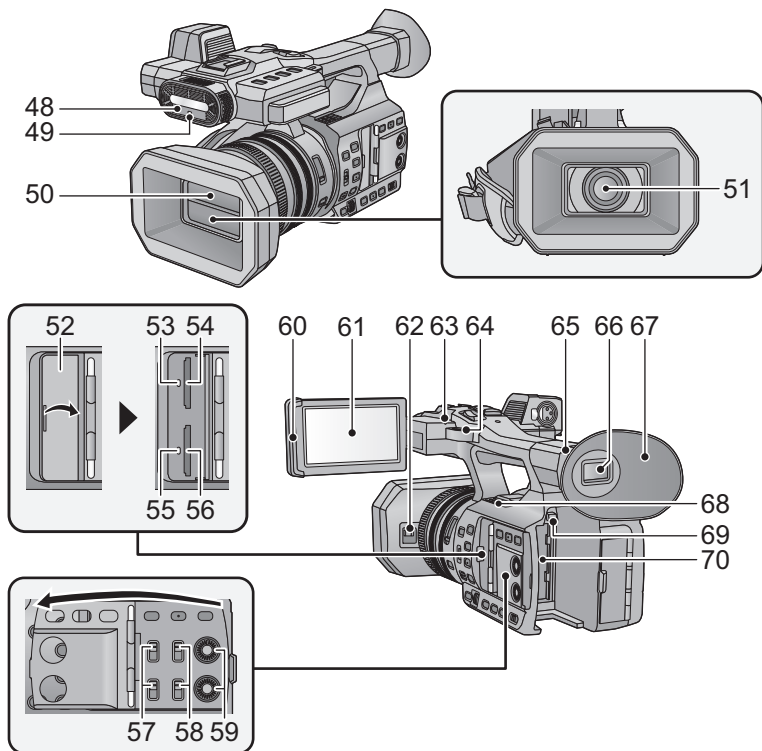

- 24 Tripod receptacle (→ 13)
- 25 Eyepiece corrector lever (→ 25)
- 26 User 5 buttons [USER5]/[FOCUS ASSIST] (→ 61)
- 27 Focus auto/Manual/ ∞ switch [FOCUS A/M/ ∞] (→ 39)
- 28 Push AF buttons [PUSH AF] (→ 40)
- 29 User 1 buttons [USER1] (→ 61)
- 30 User 2 buttons [USER2] (→ 61)
- 31 User 3 buttons [USER3] (→ 61)
- 32 User 4 buttons [USER4] (→ 61)
- 33 Focus ring (→ 39)
- 34 Zoom ring (→ 37)
- 35 Iris ring (→ 48)
- 36 Iris button [IRIS] (→ 48)
- 37 ND filter switch [ND FILTER] (→ 73)
- 38 Ring LED (→ 159)
- 39 Optical Image Stabilizer button [O.I.S.] (→ 38)
- 40 Zebra button [ZEBRA] (→ 74)
- 41 Display/Mode check button [DISP/MODE CHK] (→ 62, 74)
- 42 Menu button [MENU] (→ 28)
- 43 Multi-function dial [SEL/PUSH SET] (→ 46, 49, 51, 76, 81)
- 44 Gain button [GAIN] (→ 49)
- 45 White Balance button [W.B.] (→ 46)
- 46 Shutter speed button [SHUTTER] (→ 51)
- 47 Intelligent auto/Manual switch [iA/MANU] (→ 34)

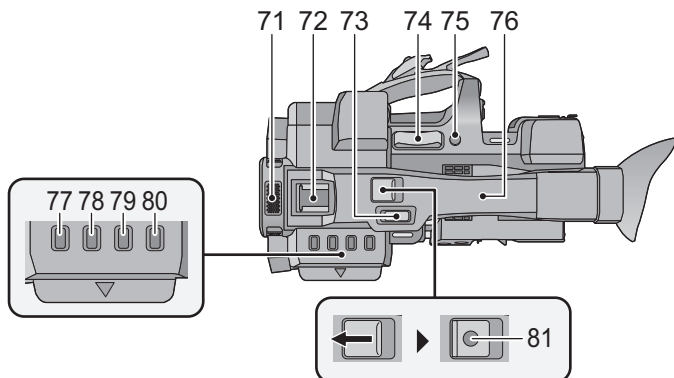

- 48 Infrared light (→ 69, 152)
- 49 Recording lamp (Front) (→ 158)
- 50 Lens cover (→ 11)
- 51 Lens (LEICA DICOMAR)
- 52 SD Card slot cover (→ 21)
- 53 Access lamp (card 1) (→ 21)
- 54 Card slot 1 (→ 21)
- 55 Access lamp (card 2) (→ 21)
- 56 Card slot 2 (→ 21)
- 57 INPUT 1, 2 switches [INPUT1, INPUT2] (→ 54)
- 58 CH1, CH2 switches [CH1, CH2] (→ 54)
- 59 Audio control knobs [CH1, CH2] (→ 55)
- 60 LCD monitor extract part (→ 23)
- 61 LCD monitor (Touch screen) (→ 24)
- 62 Lens cover open/close lever (→ 11)
- 63 Recording lamp (Rear) (→ 158)
- 64 Shoulder strap fixture (→ 12)
- 65 Eye cup attachment part (→ 11)
- 66 Viewfinder (→ 25)
- 67 Eye cup (→ 11)
- 68 Exhaust opening (cooling fan) (→ 30)
- 69 Battery release button [PUSH] (→ 15)
- 70 Battery holder (→ 15)



- 71 Internal microphones**
- 72 Accessory shoe**
- 73 Sub zoom lever (→ 37, 151)**
 - This lever functions in the same manner as the zoom lever.
- 74 Zoom lever [T/W] (In Recording Mode) (→ 37)**
 - Volume lever [+VOL-]/Thumbnail display switch [Q / 
- 75 User 6 buttons [REC CHECK] (→ 61)**
- 76 NFC touch area [**
- 77 Thumbnail button [THUMBNAIL] (→ 22)**
- 78 Counter button [COUNTER] (→ 57)**
- 79 Counter reset button [RESET] (→ 59)**
- 80 Colour Bar Screen button [BARS] (→ 72)**
- 81 Sub recording start/stop button (→ 29, 151)**
 - This button functions in the same manner as the recording start/stop button.

■ Attaching/detaching the lens hood

(How to detach the lens hood)

While pressing and holding the lens hood release button, rotate the lens hood in the direction of the arrow to detach it.

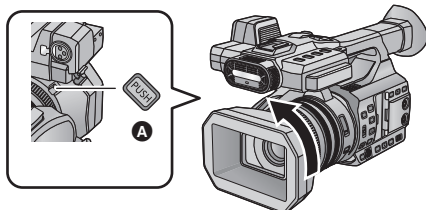

A Lens hood release button

(How to attach the lens hood)

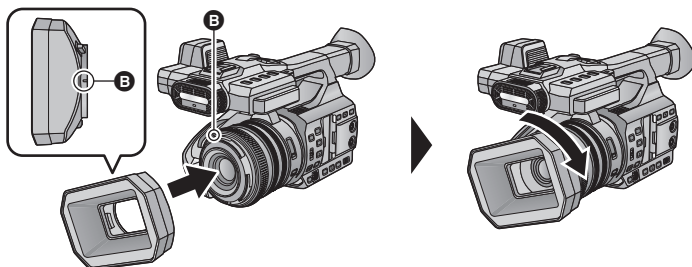

B Mounting mark

1 Fit the lens hood into this unit.

- Align the mounting mark on the lens hood with the mounting mark on this unit.
- ### 2 Rotate the lens hood in the direction of the arrow.
- Rotate until it clicks into place.

Opening/closing the lens cover

You can open/close the lens cover by sliding the lens cover open/close lever.

- When this unit is not in use, close the lens cover to protect the lens.

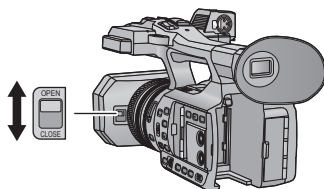

- Do not press the lens cover hard. This may damage the lens or the lens cover.
- Depending on the various filters or the MC protector attached to the front side of this unit's lens, you may not be able to open/close the lens cover or attach the lens hood.

Adjust the length of the grip belt so that it fits your hand.

Adjust the grip belt according to the size of your hand.

- If you find it difficult to fasten the buckle **B**, move the pad **A** towards you, and fasten the buckle **B** again.

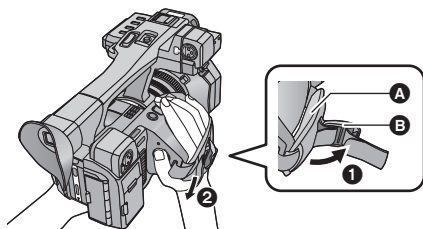

- 1 Open the buckle.
- 2 Pull the end of the belt.

Attaching the eye cup

Attach by aligning the notch of the eye cup attachment part with the protrusion at the inside of the eye cup.

- The illustration below is an example of attaching the eye cup to use it with your right eye. If you rotate the eye cup to the left by 180° before attaching it, you can use it with your left eye.

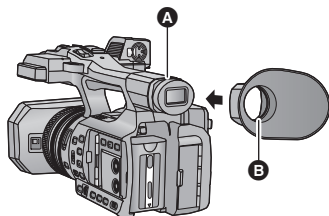

- A** Notch
- B** Protrusion

■ Attaching the Shoulder strap

We recommend that you attach the shoulder strap (supplied) before going out of doors to record so as to avoid dropping this unit.

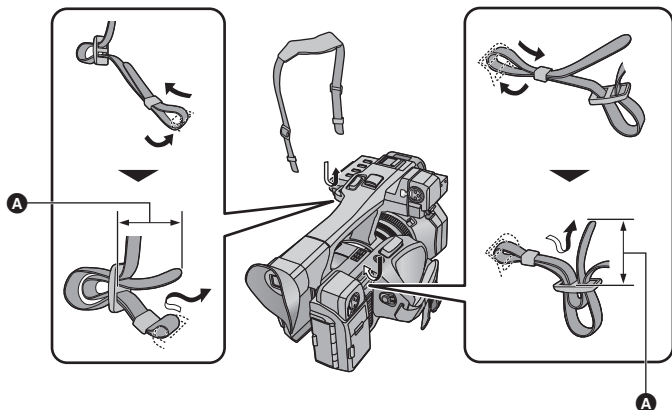

A 20 mm or longer

■ Attaching the front microphone

- The microphone holder is set up so that a 21 mm external microphone (AG-MC200G: optional) can be attached. Check in advance whether the microphone you wish to use can be attached.

1 Attach the microphone holder to the microphone holder attachment part.

- Attach by using a commercially available screw driver.
- When attaching the microphone holder, be sure to tighten the screws firmly even though you might hear a squeaking sound.

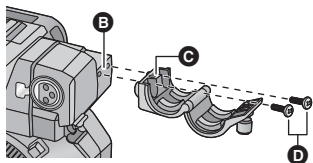

- B** Microphone holder attachment part
- C** Microphone holder
- D** Microphone holder screws

- 2 Attach an external microphone (optional) to the microphone holder, and tighten the microphone holder screws.
 - 3 Connect the external microphone to the AUDIO INPUT1 terminal (XLR 3 pin).
- When wiring the microphone cable, use the cable clamber of this unit.

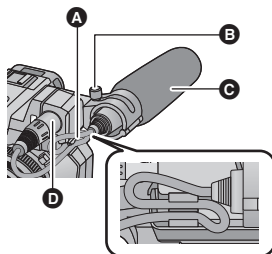

- A Microphone cable clamber
- B Microphone holder screws
- C External microphone (optional)
- D AUDIO INPUT1 terminal (XLR 3 pin)

■ Attaching the INPUT terminal cap

Attach the INPUT terminal cap while the audio input terminals 1, 2 (XLR 3 pin) is not used.

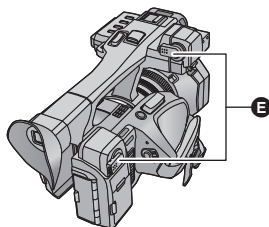

- E INPUT terminal cap

■ Attaching the tripod

- There are tripod receptacle that are compatible with 1/4-20UNC screws.
- Attaching a tripod with a screw length of 5.5 mm or more may damage the unit.

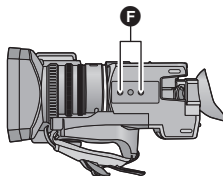

- F Tripod receptacle

Power supply

■ About batteries that you can use with this unit

The battery that can be used with this unit is VW-VBD58/CGA-D54s.

It has been found that counterfeit battery packs which look very similar to the genuine product are made available to purchase in some markets. Some of these battery packs are not adequately protected with internal protection to meet the requirements of appropriate safety standards. There is a possibility that these battery packs may lead to fire or explosion. Please be advised that we are not liable for any accident or failure occurring as a result of use of a counterfeit battery pack. To ensure that safe products are used we would recommend that a genuine Panasonic battery pack is used.

Charging the battery

When this unit is purchased, the battery is not charged. Charge the battery fully before using this unit for the first time.

Important:

- Do not use the AC cable with any other equipment as it is designed only for this unit. Also, do not use the AC cable from other equipment with this unit.
- It is recommended to charge the battery in a temperature between 10 °C and 30 °C. (The battery temperature should also be the same.)

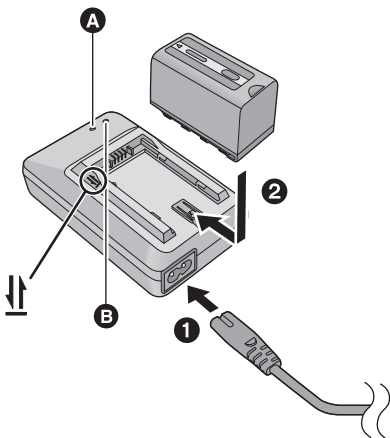

Charging lamp [CHARGE] **A**

Lights up:

Charging (Battery charging time: → 16)

Goes off:

Charging completed

Flashing:

Be sure to connect the unit correctly (→ 174)

Power lamp **B**

- This will light up when the AC cable is connected.

- Insert the plugs as far as they will go.

1 Connect the AC cable to the battery charger and the AC outlet.

2 Insert the battery into the battery charger by aligning the arrows.

- We recommend using Panasonic batteries (→ 16).
- If you use other batteries, we cannot guarantee the quality of this product.
- Do not heat or expose to flame.
- Do not leave the battery(ies) in a car exposed to direct sunlight for a long period of time with doors and windows closed.

Inserting/removing the battery

Install the battery by inserting it in the direction shown in the figure.

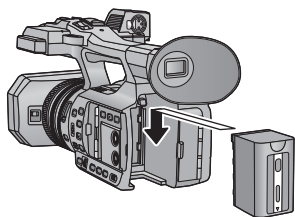

Insert the battery until it clicks and locks.

Removing the battery

Make sure that the power switch is set to OFF and the status indicator is turned off, and then remove by holding onto it taking care not to drop. (→ 22)

While pressing the battery release button, remove the battery.

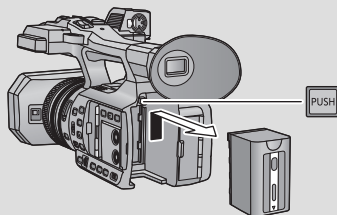

Charging and recording time

Charging/Recording time

- Temperature: 25 °C/humidity: 60%RH
- When using the viewfinder (times in parentheses are when using the LCD monitor)
- When [SYSTEM FREQ] is set to [50Hz(PAL)] (→ 159)

Battery model number [Voltage/Capacity (minimum)]	Charging time	Recording mode	Size of recording format	Continuously recordable time	Actual recordable time
Supplied battery/ VW-VBD58 (optional) [7.2 V/5800 mAh]	6 h 20 min	MOV (LPCM)	FHD	5 h 20 min (5 h)	2 h 50 min (2 h 40 min)
		MP4 (LPCM)	C4K	6 h 5 min (5 h 35 min)	3 h 10 min (2 h 55 min)
			4K	5 h (4 h 40 min)	2 h 35 min (2 h 30 min)
			FHD	5 h 20 min (5 h)	2 h 50 min (2 h 40 min)
		MP4	4K	6 h 20 min (5 h 50 min)	3 h 20 min (3 h 5 min)
			FHD	5 h 30 min (5 h 10 min)	2 h 55 min (2 h 40 min)
		AVCHD	—	5 h 30 min (5 h 10 min)	2 h 55 min (2 h 40 min)
CGA-D54s (optional) [7.2 V/5400 mAh]	6 h	MOV (LPCM)	FHD	5 h (4 h 40 min)	2 h 40 min (2 h 30 min)
		MP4 (LPCM)	C4K	5 h 40 min (5 h 15 min)	3 h (2 h 45 min)
			4K	4 h 40 min (4 h 25 min)	2 h 30 min (2 h 20 min)
			FHD	5 h (4 h 40 min)	2 h 40 min (2 h 30 min)
		MP4	4K	6 h (5 h 30 min)	3 h 10 min (2 h 55 min)
			FHD	5 h 10 min (4 h 50 min)	2 h 45 min (2 h 30 min)
		AVCHD	—	5 h 10 min (4 h 50 min)	2 h 45 min (2 h 30 min)

- When [SYSTEM FREQ] is set to [59.94Hz(NTSC)] (→ 159)

Battery model number [Voltage/Capacity (minimum)]	Charging time	Recording mode	Size of recording format	Continuously recordable time	Actual recordable time
Supplied battery/ VW-VBD58 (optional) [7.2 V/5800 mAh]	6 h 20 min	MOV (LPCM)	FHD	4 h 45 min (4 h 30 min)	2 h 30 min (2 h 20 min)
		MP4 (LPCM)	C4K	6 h 5 min (5 h 35 min)	3 h 10 min (2 h 55 min)
			4K	4 h 30 min (4 h 15 min)	2 h 20 min (2 h 15 min)
			FHD	4 h 45 min (4 h 30 min)	2 h 30 min (2 h 20 min)
		MP4	4K	5 h 45 min (5 h 25 min)	3 h 5 min (2 h 50 min)
			FHD	4 h 50 min (4 h 35 min)	2 h 35 min (2 h 25 min)
		AVCHD	—	4 h 50 min (4 h 35 min)	2 h 35 min (2 h 25 min)
CGA-D54s (optional) [7.2 V/5400 mAh]	6 h	MOV (LPCM)	FHD	4 h 30 min (4 h 15 min)	2 h 20 min (2 h 15 min)
		MP4 (LPCM)	C4K	5 h 40 min (5 h 15 min)	3 h (2 h 45 min)
			4K	4 h 15 min (4 h)	2 h 15 min (2 h 5 min)
			FHD	4 h 30 min (4 h 15 min)	2 h 20 min (2 h 15 min)
		MP4	4K	5 h 25 min (5 h 5 min)	2 h 50 min (2 h 40 min)
			FHD	4 h 35 min (4 h 20 min)	2 h 25 min (2 h 15 min)
		AVCHD	—	4 h 35 min (4 h 15 min)	2 h 25 min (2 h 15 min)

- "h" is an abbreviation for hour, "min" for minute and "s" for second.
- These times are approximations.
- **The indicated charging time is for when the battery has been discharged completely. Charging time and recordable time vary depending on the usage conditions such as high/low temperature. Recordable time also varies depending on the [REC FORMAT] setting.**
- Please refer to page 139 about recording format.



-
- The actual recordable time refers to the recordable time when repeatedly starting/stopping recording, turning the unit on/off, moving the zoom lever etc.
 - The batteries heat up after use or charging. This is not a malfunction.

Checking the remaining power of the battery

You can check the remaining power of the battery by looking at the battery capacity indication displayed on this unit's screen or by looking at the supplied battery VW-VBD58.

■ Checking the remaining power using this unit

Battery capacity indication

- The display changes as the battery capacity reduces.  If the battery discharges, then  will flash red.

- Depending on the menu setting, the battery capacity indication is not displayed (→ 155)
[DISP SETUP] → [CARD & BATTERY]

■ Checking the remaining power using the battery



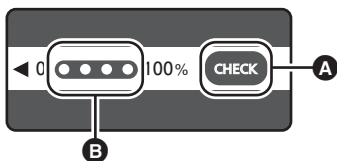

If you press the CHECK button, the remaining power indicator (LED lamp) lights up green, allowing you to check the remaining power of the battery.



- A** CHECK button
- B** Remaining power indicator
- The remaining power of the battery is an approximate guide.
- When the LED lamp does not light up even if you press the CHECK button, the battery is exhausted. Charge the battery.

How to read the remaining power indicator

○ :Lit up/ ● :Off

LED lamp status	Remaining power of the battery
	0% to 25%
	25% to 50%
	50% to 75%
	75% to 100%

- The display of the remaining power indicator is an approximate guide for the remaining power of the battery. When the battery pack is connected to the video camera or the charger, refer to the remaining power display of the connected device. The display of the connected device may differ from that of the battery pack's remaining power indicator.

Connecting to the AC outlet

The unit is in the standby condition when the AC adaptor is connected. The primary circuit is always "live" as long as the AC adaptor is connected to an electrical outlet.

Important:

- Use the supplied AC adaptor. Do not use the AC adaptor of another device.
- Do not use the AC cable with any other equipment as it is designed only for this unit. Also, do not use the AC cable from other equipment with this unit.

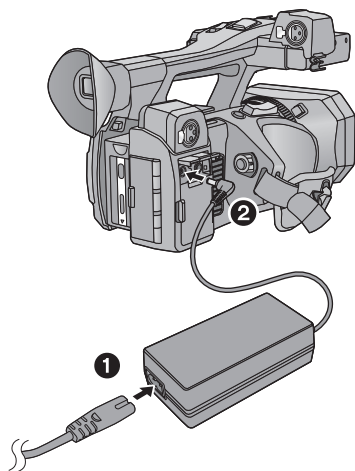

- 1** Connect the AC cable to the AC adaptor and the AC outlet.
- 2** Connect the AC adaptor to the DC input terminal [DC IN].

- Make sure to set the power switch to OFF and the status indicator is turned off when disconnecting the AC adaptor. (→ 22)

- Insert the plugs as far as they will go.

-
- Even when you use the AC adaptor for recording images, keep the battery connected. This allows you to continue the recording even if a power failure occurs or the AC adaptor is unplugged from the AC outlet by accident.

Preparation of SD cards

The unit can record motion pictures or still pictures to an SD card.

Cards that you can use with this unit

Card type	Capacity
SDHC Memory Card	4 GB to 32 GB
SDXC Memory Card	48 GB/64 GB

- **When using an SDHC Memory Card/SDXC Memory Card with other equipment, check the equipment is compatible with these Memory Cards.**
- We do not guarantee the operation of SD cards other than the ones above.
- 4 GB or more Memory Cards that do not have the SDHC logo or 48 GB or more Memory Cards that do not have the SDXC logo are not based on SD Memory Card Specifications.
- This unit is compatible with UHS-I UHS Speed Class 3 standard SDHC/SDXC memory cards.
- When the write-protect switch **A** on SD card is locked, no recording, deletion or editing will be possible on the card.
- Keep the Memory Card out of reach of children to prevent swallowing.

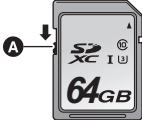

■ About the Speed Class ratings for recording motion pictures

- Depending on [REC MODE] and [REC FORMAT] (→ 139), the required card differs.
Use a card that meets the following ratings of the SD Speed Class or UHS Speed Class.
Use of a non-compatible card may cause recording to stop suddenly.
- SD Speed Class and UHS Speed Class are the speed standards regarding continuous writing. To check the class, see the labelled side, etc. of the card.

Recording modes	Bit rates in [REC FORMAT]	Speed Class ratings	Label examples
MOV (LPCM)/ MP4 (LPCM)/ MP4	100 Mbps or more	UHS Speed Class3	U3
	50 Mbps	UHS Speed Class1 or more	U1
		Class10 or more	CLASS10
AVCHD	All	Class4 or more	CLASS4

Inserting/removing an SD card

When using a non Panasonic SD card for the first time, or one which was previously used on another equipment, it is necessary to format the SD card. (→ 30) When the SD card is formatted, all of the recorded data is deleted. Once the data is deleted, it cannot be restored.

Caution:

Check that the access lamp has gone off.

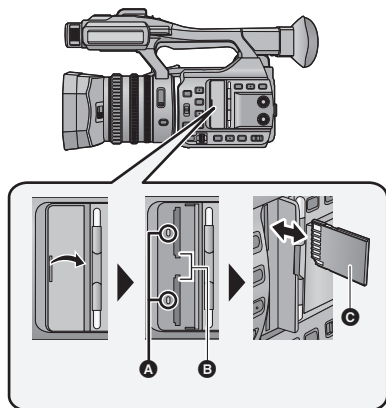

Access lamp **A**

- When this unit is accessing the SD card, the access lamp lights up.

1 Open the SD card slot cover and insert (remove) the SD card into (from) the card slot **B**.

- One SD card can be inserted into each of the card slot 1 and the card slot 2.
- Face the terminal side **C** in the direction shown in the illustration and press it straight in as far as it will go.
- Press the centre of the SD card and then pull it straight out.

2 Securely close the SD card slot cover.

- Do not touch the terminals on the back of the SD card.
- Do not apply strong shocks, bend, or drop the SD card.
- Electrical noise, static electricity or the failure of this unit or the SD card may damage or erase the data stored on the SD card.
- When the card access lamp is lit, do not:
 - Remove the SD card
 - Turn the unit off
 - Insert and remove the USB cable
 - Expose the unit to vibrations or shockPerforming the above while the lamp is on may result in damage to data/SD card or this unit.
- Do not expose the terminals of the SD card to water, dirt or dust.
- Do not place SD cards in the following areas:
 - In direct sunlight
 - In very dusty or humid areas
 - Near a heater
 - Locations susceptible to significant difference in temperature (condensation can occur.)
 - Where static electricity or electromagnetic waves occur
- To protect SD cards, return them to their cases when you are not using them.
- About disposing of or giving away the SD card. (→ 174)

Turning the unit on/off

Set the power switch to ON while pressing the lock release button **B** to turn on the unit.

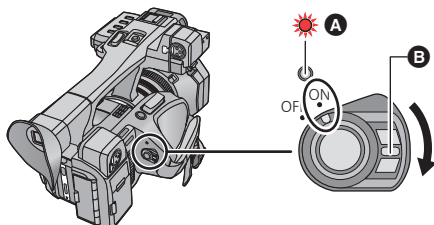

To turn off the unit

Set the power switch to OFF while pressing the lock release button. The status indicator goes off.

A The status indicator lights on.

- To turn on the unit again after the [ECONOMY (BATT)] or [ECONOMY (AC)] is activated, set the power switch to OFF once, and then to ON again. (→ 160)

Selecting a mode

Press the THUMBNAIL button to change the mode to Recording Mode or Playback Mode.

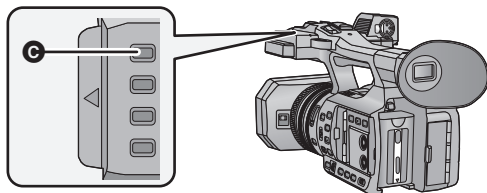

C THUMBNAIL button

Recording Mode (→ 31, 32)	The recording screen is displayed. You can record motion pictures and still pictures.
Playback Mode (→ 79)	The thumbnail screen for playback is displayed. You can play back motion pictures and still pictures.

- When you turn on this unit, it starts up in Recording Mode.
- If you press the recording start/stop button or sub recording start/stop button in Playback Mode, the mode will be switched to Recording Mode and recording will start.

Using the LCD monitor/Viewfinder

The viewfinder is turned off and the LCD monitor is turned on when the LCD monitor is extracted.
The viewfinder is turned on when the LCD monitor is retracted.

Using the LCD monitor

1 Extract the LCD monitor in the direction as indicated in the figure.

- Hold the LCD monitor extract part **A**, and extract the LCD monitor until it clicks into position.

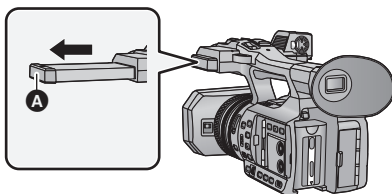

2 Rotate to the position that is easy to view.

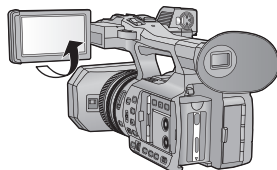

To retract the LCD monitor

Retract as shown in the figure with the LCD facing downward.

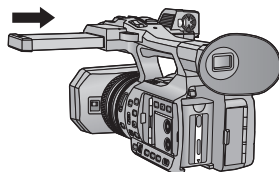

Range of rotation of the LCD monitor

- It can rotate up to 270° **B** towards the lens.

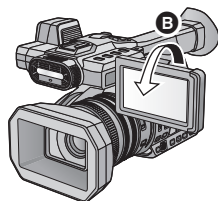

How to use the touch screen

You can operate by directly touching the LCD monitor (touch screen) with your finger.

■ Touch

Touch and release the touch screen to select icon or picture.

- Touch the centre of the icon.
- Touching the touch screen will not operate while you are touching another part of the touch screen.

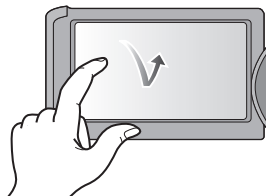

■ Slide while touching

Move your finger while pressing on the touch screen.

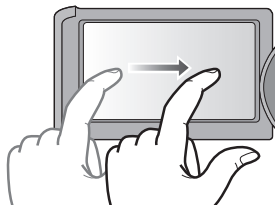

■ About the operation icons



Touch when changing a page or performing settings.

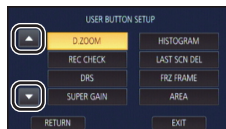

- Do not touch the LCD monitor with hard pointed tips, such as ball point pens.

LCD monitor adjustment

- These settings will not affect the images actually recorded.

[POWER LCD]

This makes it easier to view the LCD monitor in bright places including outdoors.

Select the menu. (→ 28)

 : [DISP SETUP] → [POWER LCD] → desired setting

 (Makes brighter) /  (Normal) /  (Makes less bright)

- When the AC adaptor is in use, [POWER LCD] is set to  automatically.
- Recordable time with the battery is shortened when the LCD is made brighter.

[LCD SET]

It adjusts brightness and colour density on the LCD monitor.

1 Select the menu. (→ 28)



[DISP SETUP] → [LCD SET]

2 Touch the desired setting item.

[COLOUR]: Colour level of the LCD monitor

[BRIGHTNESS]: Brightness of the LCD monitor

[CONTRAST]: Contrast of the LCD monitor

3 Touch ◀/▶ to adjust settings.

4 Touch [ENTER].

- Touch [EXIT] to exit the menu screen.

Viewfinder adjustment

- These settings will not affect the images actually recorded.

Adjusting the field of view

It adjusts the field of view to show the image on the viewfinder clearly.

1 Adjust the viewfinder to suit your vision so that you can see the display images clearly.

- Be careful not to trap your fingers when moving the viewfinder.
- The viewfinder can be lifted vertically up to approximately 90°.
- Retract the LCD monitor and turn on the viewfinder.

2 Adjust the focus by operating the eyepiece corrector lever.

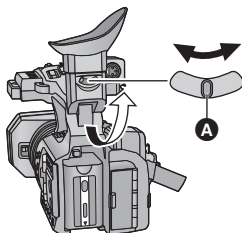

A Eyepiece corrector lever

[EVF SET]

Brightness of the viewfinder can be switched.

Select the menu. (→ 28)



[DISP SETUP] → [EVF SET] → [BRIGHT]/[NORMAL]/[DARK]

[EVF COLOUR]

The recording images or playback images on the viewfinder can be selected between colour/black and white.

Select the menu. (→ 28)

 : [DISP SETUP] → [EVF COLOUR] → [ON] or [OFF]

[ON]: Displayed in colour

[OFF]: Displayed in black and white

Recording yourself

- Change the mode to Recording Mode. (→ 22)
- **Rotate the LCD monitor towards the lens side.**
- Displaying during the recording yourself can be switched by setting [SELF SHOOT]. (→ 156)

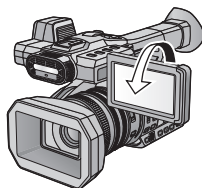

- Only some indications will appear on the screen when the [SELF SHOOT] is set to [MIRROR]. When  appears, return the direction of the LCD monitor to normal position and check the warning/alarm indication. (→ 167)

Setting date and time

When this unit is turned on, the message [SET TIME ZONE AND DATE/TIME] may appear. To make these settings, select [YES], and follow the instructions from Step 2-3 of the time zone setting procedure.

1 Select the menu. (→ 28)

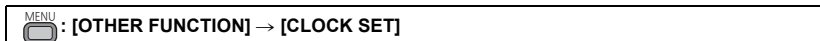

2 Touch the date or time to be set, then set the desired value using ▲/▼.

- The year can be set between 2000 and 2039.

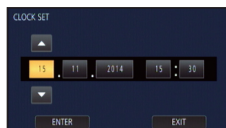

3 Touch [ENTER].

4 Touch [EXIT] to complete the setting.

- The date and time function is driven by a built-in lithium battery.
- If the time display becomes [- -], the built-in lithium battery needs to be charged. To recharge the built-in lithium battery, connect the AC adaptor or attach a charged battery to this unit. Leave the unit as it is for approx. 24 hours and the battery will maintain the date and time for approx. 6 months. (The battery is still being recharged even if the unit is off.)
- The way that time is displayed can be changed in the menu settings. (→ 154, 155) [DISP SETUP] → [DATE/TIME] or [DATE FORMAT]

Time zone

Time difference from the Greenwich Mean Time can be set.

1 Select the menu. (→ 28)

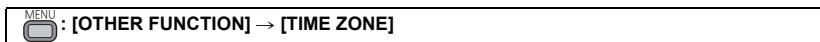

2 Touch ◀/▶ and set the region to record.

3 Touch [ENTER].

- If the [CLOCK SET] screen appears, perform [CLOCK SET].

4 Touch [EXIT] to complete the setting.

- When the time zone setting is changed, the date/time setting of the unit also changes automatically.

Using the menu screen

- You can select menu items by operating the multi-function dial. (→ 76)

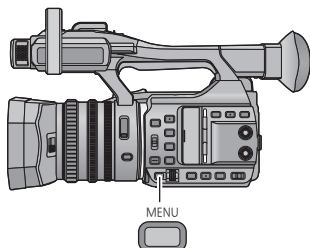

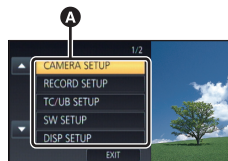

1 Press the MENU button .

2 Touch the top menu **A**.



3 Touch the submenu **B**.

- Next (Previous) page can be displayed by touching  / .



4 Touch the desired item to enter the setting.

5 Touch [EXIT] to exit the menu setting.

Before recording

■ Basic camera positioning

Normal recording



- Put your hand through the grip belt and hold the unit with both hands.

Recording from a high position



Low-angle recording



- For easier low-angle recording, the sub recording start/stop button and the sub zoom lever can be used.

- When recording, make sure your footing is stable and there is no danger of colliding with another person or object.
- Hold the eye cup of the viewfinder as close as possible to your eye.
- Adjust the angle of the LCD monitor according to the position in which the unit is held.
- When you are outdoors, record pictures with the sunlight behind you. If the subject is backlit, it will become dark in the recording.
- Keep your arms near your body and separate your legs for better balance.
- For stable images, it is recommended to use a tripod whenever possible.
- Do not block the cooling fan inlet or the exhaust opening with your hand or other objects.

Formatting media

If you use the SD cards for the first time for recording with this unit, format the cards. Please be aware that if a medium is formatted, then all the data recorded on the medium will be erased and cannot be restored. Back up important data on a PC etc. (→ 93)

- When using two SD cards, format both SD cards.

1 Select the menu.

 : [OTHER FUNCTION] → [FORMAT MEDIA]

2 Touch [SD CARD 1] or [SD CARD 2].

- When formatting is complete, touch [EXIT] to exit the message screen.

- Do not turn this unit off or remove the SD card, while formatting. Do not expose the unit to vibrations or shock.

Use this unit to format media.

Do not format an SD card using any other equipment such as a PC. Otherwise it may not be possible to use the card on this unit.

Recording 

Selecting a media to record

[SD CARD 1] and [SD CARD 2] can be selected separately to record motion pictures or still pictures.

1 Select the menu.

 : [RECORD SETUP] → [MEDIA SELECT]

2 Touch the media to record motion pictures or still pictures.

- The media is selected separately for motion pictures or still pictures and is then highlighted in yellow.

3 Touch [ENTER].

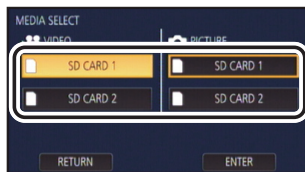



Recording motion pictures

- Before turning on this unit, open the lens cover. (→ 11)

1 Change the mode to Recording Mode. (→ 22)

- Extract the LCD monitor.

2 Press the recording start/stop button **B** to start recording.

- Recording will stop when you press the recording start/stop button again.

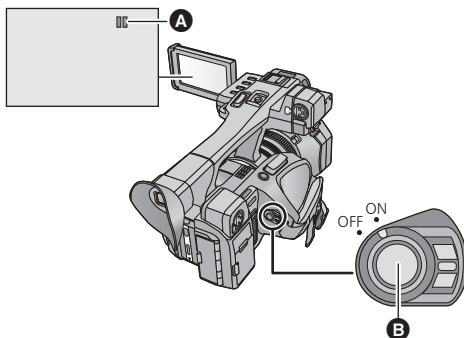

A When you begin recording, **II** changes to **●**.

■ Screen indications in the Recording Mode



TC 00:00:00:00	Counter display (→ 57)
1 (White)	Media where the motion picture is recorded (→ 30)
R 1h20m	Approximate remaining recordable time <ul style="list-style-type: none"> • When the remaining time is less than 1 minute, R 0h00m flashes red.
4K 2/60	Recording format (→ 139)
150M	Bit rate (→ 139)
MP4 (LPCM)	Recording mode (→ 139)
50p	Frame rate (→ 139)

- To change the recording method, change [REC MODE] or [REC FORMAT]. (→ 139)
- The images recorded between pressing the recording start/stop button to start recording and pressing it again to pause recording become one scene.

- When the file size of a recorded scene exceeds one of the following sizes or the recording time exceeds one of the following lengths of time, the scene will be divided automatically.
 - AVCHD scene: approximately 4 GB or 30 minutes
 - MOV/MP4 scene (when using an SDHC memory card): approximately 4 GB or 30 minutes
 - MOV/MP4 scene (when using an SDXC memory card): approximately 48 GB or 120 minutes
- (Maximum recordable scenes of a single SD card)

Recording mode	MOV (LPCM)/MP4 (LPCM)/MP4	AVCHD
Recordable scenes	Approx. 89100	Approx. 3900
Different dates (→ 86)	Approx. 900	Approx. 900

- When the SD card contains scenes recorded with [REC MODE] set to [MOV(LPCM)]/[MP4(LPCM)]/[MP4] and still pictures, the maximum recordable scenes and the maximum recordable scenes on each date will be smaller than those in the table above.
- Number of scenes that can be recorded will be less than above in following cases:
 - If you change [REC FORMAT] (→ 139)
 - When [2 SLOTS FUNC.] is set to [SIMULTANEOUS]
 - During the Interval Recording
- Please refer to page 177 about approximate recordable time.

Recording



Recording still pictures

- Before turning on this unit, open the lens cover. (→ 11)
- Register [CAPTURE] to a USER button. (→ 61)

1 Change the mode to Recording Mode. (→ 22)

- Extract the LCD monitor.

2 Press the USER button to which [CAPTURE] is registered or touch the applicable USER button icon to record a still picture.

- For information on the locations of the USER buttons and information on USER button icons, refer to page 61.
- When still pictures are being recorded, the remaining recordable number of still pictures and the still picture indication are displayed.

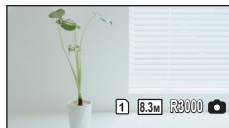

■ About the screen indications while recording still pictures



	Size of still pictures
R3000	Remaining number of still pictures
	Still picture indication (→ 165)

■ About picture size

Picture sizes in which still pictures will be recorded differ depending on the [REC MODE] setting and the [REC FORMAT] setting (→ 139).

Recording mode	Recording format	Aspect	Picture size
MOV (LPCM)/ MP4 (LPCM)/ MP4	[REC FORMAT] setting with a size of C4K (4096×2160)	17:9	 4096×2160
	[REC FORMAT] setting with a size of 4K (3840×2160)	16:9	 3840×2160
	[REC FORMAT] setting with a size of FHD (1920×1080)		 1920×1080
AVCHD	All [REC FORMAT] settings		

- **It is possible to record still pictures while recording motion pictures. (rec-and-capture)**
- It is recommended to use a tripod when recording under low light conditions because the shutter speed becomes slow.
- If rec-and-capture is used while recording a motion picture, the remaining recordable time will shorten. If you turn off this unit or press the THUMBNAIL button, the remaining recordable time may become longer.
- Maximum number of recordable pictures that can be displayed is 9999. If the number of recordable pictures exceeds 9999, R 9999+ is displayed. The number will not change when the picture is taken until the number of recordable pictures is 9999 or less.
- When playing back a still picture recorded with this unit in the 17:9 aspect, black bands appear on the top and bottom of the screen.
- The 17:9 or 16:9 still pictures recorded using this unit may be cropped at the edges when printed. So, be sure to check before printing in the store or on your printer.
- Please refer to page 179 about approximate number of recordable pictures.
- The recording time may be long depending on the recording condition.

Intelligent Auto Mode/Manual Mode

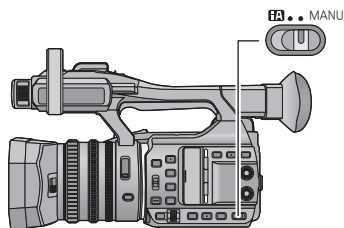

iA/MANU switch

Slide the switch to change the Intelligent Auto Mode/Manual Mode.

- **MNL** is displayed in the Manual Mode.
- The following modes appropriate for the condition are set just by pointing the unit to what you want to record in the Intelligent Auto Mode.

Mode	Effect
Scenery	The whole landscape will be recorded vividly without whitening out the background sky, which may be very bright.
Spotlight	Very bright object is recorded clearly.
Low light*	It can record very clearly even in a dark room or twilight.
Normal	In modes other than those described above, the contrast is adjusted to give a clear picture.

* When [SLOW SHUTTER] (→ 148) is [OFF], Low Light Mode will not be entered.

- Depending on the recording conditions, the unit may not enter the desired mode.

■ Intelligent Auto Mode

When switching to Intelligent Auto Mode, the Automatic White Balance and Auto Focus operate and automatically adjust the colour balance and focusing.

Depending on the brightness of the subject etc., the Iris, gain and shutter speed are automatically adjusted for an optimum brightness.

- Colour balance and focus may not be adjusted automatically depending on light sources or scenes. If so, manually adjust these settings. (→ 39, 46)
- The following functions are adjusted automatically when you set this unit to Intelligent Auto Mode. The settings in Manual Mode will not be maintained.
 - Focus (→ 39)
 - Focus Assist (→ 40)
 - White Balance (→ 46)
 - Iris adjustment (→ 48)
 - Gain adjustment (→ 49)
 - Shutter speed (→ 51)
 - ND filter (→ 73)
- When you switch this unit from Manual Mode to Intelligent Auto Mode, Image Stabilizer will be set to / ([ON]). (→ 38)

- If you set the Image Stabilizer to  (setting cancelled) in Manual Mode and set this unit to Intelligent Auto Mode, the Image Stabilizer setting when this unit is reset to Manual Mode will be determined by whether or not you press the Optical Image Stabilizer button.

When the Optical Image Stabilizer button is pressed	The Image Stabilizer setting in Intelligent Auto Mode will be applied.
When the Optical Image Stabilizer button is not pressed	The Image Stabilizer will be set to  (setting cancelled).

Automatic White Balance

The illustration shows the range over which Automatic White Balance functions.

- 1) The effective range of Automatic White Balance adjustment on this unit
- 2) Blue sky
- 3) Cloudy sky (rain)
- 4) Sunlight
- 5) White fluorescent lamp
- 6) Halogen light bulb
- 7) Incandescent light bulb
- 8) Sunrise or sunset
- 9) Candlelight

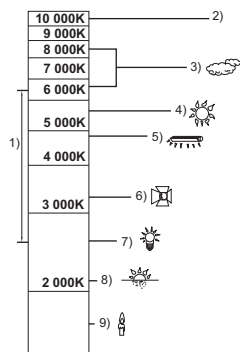

If the Automatic White Balance is not functioning normally, adjust the White Balance manually. (→ 46)

Auto Focus

The unit focuses automatically.

- Auto Focus does not work correctly in the following situations.
 - Record pictures in the Manual Focus Mode. (→ 39)
 - Recording distant and close-up objects at the same time
 - Recording a subject behind dirty or dusty window
 - Recording a subject that is surrounded by objects with glossy surfaces or by highly reflective objects

■ List of available/unavailable camera operations in Intelligent Auto Mode/Manual Mode

(○: Available; —: Unavailable)

	Intelligent Auto Mode	Manual Mode
Zoom lever	○	○
Sub zoom lever	○	○
Counter button	○	○
Counter reset button	○	○
Colour Bar Screen button	○	○
Focus ring	—	○
Zoom ring	○	○
Iris ring	—	○
ND filter switch	—	○
Iris button	—	○

	Intelligent Auto Mode	Manual Mode
Focus auto/Manual/ ∞ switch	—	○
Push AF button	—	○
INPUT 1, 2 switches	○	○
CH1, CH2 switches	○	○
Audio control knobs	○	○
Optical Image Stabilizer button	○	○
Zebra button	○	○
Display/Mode check button	○	○
Gain button	—	○
White Balance button	—	○
Shutter Speed button	—	○

- Some of the USER buttons 1–6 may not be available in Intelligent Auto Mode depending on the registered USER button functions. When the following functions are registered to the USER buttons, use them in Manual Mode. (→ 61, 63)
 - DRS
 - Super Gain
 - Area Mode
 - Focus Transition
 - Infrared light
 - Flash band compensation

Intelligent Auto Plus

You can adjust the brightness and colour balance in Intelligent Auto Mode. Icons will be displayed as follows:

 (Scenery) /  (Spotlight) /  (Low Light) /  (Normal)

- Set this unit to Intelligent Auto Mode. (→ 34)

1 Select the menu.

 : [CAMERA SETUP] → [Intelligent Auto Plus] → [SET]

2 Touch the desired setting item.

[EXPOSURE]: Adjusts the brightness.

[COLOUR]: Adjusts the colour balance.

3 Touch / to adjust settings.

- (When adjusting the colour balance)
 - R side: Sets the balance to a reddish tone.
 - B side: Sets the balance to a bluish tone.

4 Touch [ENTER].

- Touch [EXIT] to exit the menu screen.



Using the zoom

It can be zoomed up to 20×.

- (When the picture size of [REC FORMAT] (→ 139) is 1920×1080 or below)
It can zoom up to 40× when the [i.Zoom] is set to [ON]. (→ 147)
- Zoom magnification can be checked in the screen display of Z00 to Z99. The value gets larger when zoomed in, and the value gets smaller when zoomed out. **Z**99 is displayed during the i.Zoom.

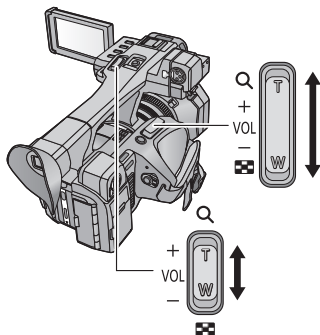

Zoom lever/Sub zoom lever

T side:

Close-up recording (zoom in)

W side:

Wide-angle recording (zoom out)

Ring zoom

Zoom operation can be done using the zoom ring.

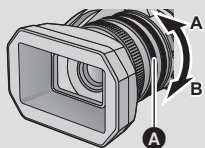

Zoom ring **A**

Zoom by rotating the ring.

A side:

Wide-angle recording (zoom out)

B side:

Close-up recording (zoom in)

■ About the zoom speed

- The zoom speed will vary depending on how far the zoom lever is pressed or how fast the zoom ring is rotated.
- The zoom operation using the sub zoom lever will be performed at a constant speed. Zoom speed of the sub zoom lever will vary depending on the setting of [SUB ZOOM]. (→ 151)

- If you take your finger off the zoom lever during zoom operation, the operation sound may be recorded. When returning the zoom lever to the original position, move it quietly.
- The sound of the zoom mechanism becomes louder than usual during fast zoom operation. This may cause the sound to be recorded during recording.
- It can be focused approximately 1.5 m or further when the zoom magnification is at its maximum.
- It can be focused approximately 3.0 cm or further when the zoom magnification is set to 1×.

Utilizing the USER button

Digital zoom can be used by setting the USER button. (→ 65)

- Please refer to page 61 for details about setting the USER button.

Recording

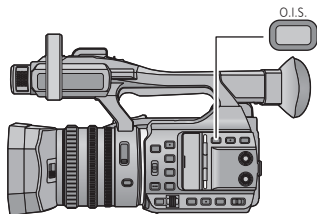

Image Stabilizer Function

Use the Image Stabilizer to reduce the effects of shake during recording.

This unit is equipped with Hybrid Optical Image Stabilizer.

Hybrid Optical Image Stabilizer is a hybrid of Optical and Electrical Image Stabilizer.



Optical Image Stabilizer button

Press the button to turn Optical Image Stabilizer on/off.

◀ [Hand icon] ▶ | [Hand icon] → (setting cancelled)

- When [HYBRID O.I.S.] is [ON], ◀ [Hand icon] ▶ is displayed. When [OFF], [Hand icon] is displayed.

■ Changing Image Stabilizer Mode

MENU : [RECORD SETUP] → [HYBRID O.I.S.] → [ON] or [OFF]

When set to [ON], you can further improve image stabilization for holding the unit and recording a distant subject with zoom.

- This cannot be set when Optical Image Stabilizer is set to [Hand icon] (setting cancelled).
- When the size is set to C4K (4096×2160) or 4K (3840×2160) in [REC FORMAT], [HYBRID O.I.S.] is set to [OFF]. (→ 139)

- Stabilization may not be possible under strong shaking conditions.
- When using a tripod, we recommend that you set the Image Stabilizer to [Hand icon] (setting cancelled).



Focus

Perform focus adjustments using the focus ring. If auto focusing is difficult due to the conditions, then use Manual Focus.

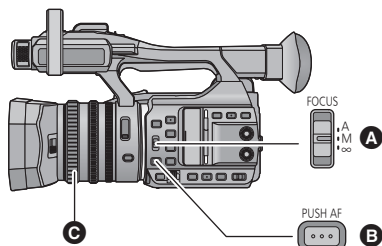

- A** FOCUS A/M/∞ switch
- B** Push AF button
- C** Focus ring

- Switch to Manual Mode. (→ 34)

1 Set the FOCUS A/M/∞ switch to [M] to enable Manual Focus.

- It will switch to MF from AF.

2 Adjust the focus by rotating the focus ring.

- The focus value can be set from MF00 (focus distance: approximately 3.0 cm) to MF99 (focus distance: infinity). The larger the focus value gets, the further the position where focus is achieved.
 - If you move the FOCUS A/M/∞ switch towards [∞], focus will be adjusted to MF95 on the infinity side. (The FOCUS A/M/∞ switch will return to the [M] position.)
 - To return to Auto Focus, set the FOCUS A/M/∞ switch to [A] or set this unit to Intelligent Auto Mode using the iA/MANU switch.
-
- When the distance to the subject approaches within 1.5 m approx., the unit switches to the macro range and [AF] or [MF]. (The unit may switch to the macro range even when the distance to the subject is 1.5 m or more depending on the subject.)
 - Depending on the zoom magnification, this unit may fail to switch to the macro range, or go to a non-displayed focus value.
 - When you perform a zoom operation in the macro range, this unit may go out of focus.
 - When a remote control (commercially-available) is connected, even if you move the FOCUS A/M/∞ switch towards [∞], focus cannot be adjusted to MF95. (→ 6)

■ To emphasise the outline of images

Setting [EVF/LCD DETAIL] to [ON] helps you achieve focus easier by emphasizing the outlines of an image displayed on the LCD monitor and viewfinder.

You can also adjust the emphasis level or change the frequency.

- You can also enable or disable this function with the applicable USER button. (→ 61)
- These settings will not affect the images actually recorded.

 : [DISP SETUP] → [EVF/LCD DETAIL] → [ON]

Adjusting the level of [EVF/LCD DETAIL]

1 Select the menu.

 : [DISP SETUP] → [EVF/LCD PEAK LEVEL]

2 Touch / to adjust settings.

3 Touch [ENTER].

- Touch [EXIT] to exit the menu screen.

Setting the peaking frequency of [EVF/LCD DETAIL]

 : [DISP SETUP] → [EVF/LCD PEAK FREQ.] → [HIGH] or [LOW]

- [EVF/LCD DETAIL] is cancelled in following cases:
 - If you use Focus Assist (→ 40)

Push AF

When using Manual Focus, you can temporarily use Auto Focus by pressing the PUSH AF button.

1 Set this unit to Manual Focus. (→ 39)

2 Press and hold the PUSH AF button.

- The focus position will be automatically adjusted for the subject at the centre of the screen.
- If you set [AREA MODE] to [FOCUS], [FOCUS/IRIS] or [FOCUS/Y GET] and use Area Mode, the focus position will be automatically adjusted to the subject you have touched. (→ 68)
- It will be cancelled when the button is released.

- The focus position set by the Push AF will be maintained when cancelled.
- Push AF does not work in following cases:
 - In Intelligent Auto Mode
 - When the FOCUS A/M/∞ switch is set to [A]
 - When a remote control (commercially-available) is connected (→ 6)

Focus Assist

You can use Focus Assist by registering [FOCUS ASSIST] to a USER button.

- This function is registered to the USER5 button by default.
- Please refer to page 61 for details about setting the USER button.

Selecting a Focus Assist method

MENU : [CAMERA SETUP] → [FOCUS ASSIST] → desired setting

[EXPAND]: Magnifies the central area of the screen when Focus Assist is used.

[PEAKING]: Highlights in-focus portions with colour when Focus Assist is used.

[BOTH]: Sets both [EXPAND] and [PEAKING].

Using Focus Assist

- Switch to Manual Focus Mode. (→ 34)
- Register [FOCUS ASSIST] to a USER button. (→ 61)

Press the USER button to which [FOCUS ASSIST] is registered or touch the applicable USER button icon.

- To turn off Focus Assist, perform the following operations:
 - Press the USER button or touch the USER button icon again.*
 - Touch [EXIT]

* You can turn off Focus Assist by touching the USER button icon only when [FOCUS ASSIST] is set to [PEAKING].

■ To adjust the magnified display

When [FOCUS ASSIST] is set to [EXPAND] or [BOTH], the central area of the screen will be magnified. You can change the magnification level and position of the magnified display.

- You can also change the magnification level of the magnified display using the multi-function dial.

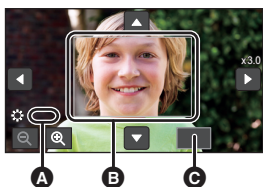

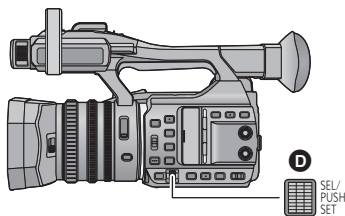

- A** [ASSIST]
- B** Magnified display
- C** [EXIT]



- D** Multi-function dial

(To change the magnification level)

Touch  /  or rotate the multi-function dial to change the magnification level.







 : Increases the magnification level by 0.5×.

 : Decreases the magnification level by 0.5×.

- You can adjust the magnification from 3× to 10×.
- The magnified area is displayed in full screen when the magnification is set to a level between 5.5× and 10×.

(Moving the magnified area)

Touch  /  /  /  or slide the screen while touching it to move the magnified area.

- The zoom position  window will be displayed.

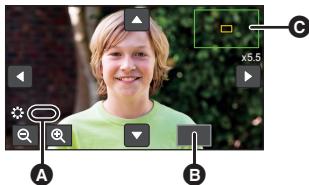

 [ASSIST]

 [EXIT]

■ To change the peaking settings

When [FOCUS ASSIST] is set to [PEAKING] or [BOTH], in-focus portions are highlighted with colour. (peaking )

- You can set the peaking colour and strength.

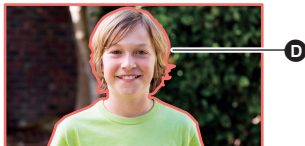

(When changing the peaking colour)

 : [CAMERA SETUP] → [PEAKING COLOUR] → desired colour

[Red]/[Blue]/[Yellow]/[White]

(When setting the peaking strength)

1 Select the menu.

 : [CAMERA SETUP] → [PEAKING LEVEL] → desired setting

2 Touch / to adjust settings.

3 Touch [ENTER].

- Touch [EXIT] to complete the setting.

(Notes on Focus Assist)

- Focus Assist is not possible in following cases:
 - During Recording Check (→ 66)
 - During Freeze Frame (→ 67)
 - When colour bars are displayed. (→ 72)

- Focus Assist is cancelled in following cases:
 - If you turn the unit off
 - If you press the THUMBNAIL button
 - When the setting of [FOCUS ASSIST] (→ 40) is changed
 - When EVF/LCD detail is enabled. (→ 40)
 - When you set this unit to Intelligent Auto Mode using the iA/MANU switch.
 - When you set the FOCUS A/M/∞ switch to [A]
 - When you press the USER button to which [FOCUS TRANSITION] is registered or touch the applicable USER button icon (→ 61)
- The magnified display and peaking are not displayed on recorded images.
- The magnified display and peaking are not displayed on a TV.
- Freeze Frame is not available when you use Focus Assist. (→ 67)
- Peaking may not be displayed when you use Digital Zoom (→ 65). To zoom in and use peaking at the same time, we recommend setting [FOCUS ASSIST] to [BOTH] and increasing the magnification level of the magnified display.

(Notes on the magnified display of Focus Assist)

- Some information on the screen disappears when the screen is magnified.
- Still pictures cannot be recorded when the screen is magnified.
- In the following cases, the screen is not magnified during Focus Assist:
 - During motion picture recording or PRE-REC (→ 146)
 - When using Digital Zoom
 - When using Area Mode (→ 68)
- If you set the magnification level of the magnified display to 5.5× or higher, peaking may not be displayed when using i.Zoom (→ 37).

Focus Transition

You can use Focus Transition by registering "Focus Transition" to a USER button. With Focus Transition, you can shift the current focus position to a pre-registered focus position.

- Please refer to page 61 for details about setting the USER button.

Registering a focus position

To use Focus Transition, you need to register a focus position.

- You can register up to three focus positions.
- **Switch to Manual Mode.** (→ 34)

1 Select the menu.

 : [CAMERA SETUP] → [FOCUS TRANSITION] → [Setup]

- The current focus position will be registered as an initial position.

2 Adjust the focus by rotating the focus ring.

3 Touch the item to which you want to register the focus position.

[1]/[2]/[3]

- The icon of the item to which the focus position has been registered will be highlighted in yellow.
- To select a different item, perform the operations in Steps 2–3.

4 Touch [EXIT] to complete the setting.

- The focus positions of the items you have set will be registered.

- The focus position settings are cancelled in the following cases:

- If you turn the unit off
- If you press the THUMBNAIL button
- If you operate the zoom

Using Focus Transition

- Select the [FOCUS TRANSITION] menu. (→ 43)
- Register [FOCUS TRANS] to a USER button. (→ 61)

1 Switch to Manual Focus Mode. (→ 34)

2 Press the USER button to which [FOCUS TRANSITION] is registered or touch the applicable USER button icon.

3 Touch a registered item ([1]–[3]).

- Focus Transition will start. Focus will shift slowly from the current position to the registered position. This will take a few seconds. (→ 45)
- As the focus shifts, the Focus Transition bar will move from [S] to [E].
- If you touch [INIT], focus will shift to the initial focus position registered in Step 1 of "Registering a focus position" (→ 43).

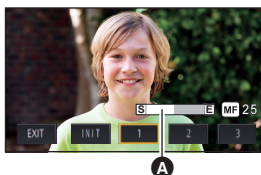

A Focus Transition bar

4 Touch [EXIT] to exit Focus Transition.

- Focus Transition is not available in the following cases:

- During Freeze Frame (→ 67)
- In Intelligent Auto Mode
- When the FOCUS A/M/∞ switch is set to [A]
- When colour bars are displayed.
- When a remote control (commercially-available) is connected (→ 6)

- Focus Transition settings are cancelled in the following cases. To use Focus Transition again, register a focus position again. (→ 43)

- If you operate the zoom
- If you enable/disable [INFRARED REC] (→ 146)

- You can switch between the items or exit Focus Transition by pressing the USER buttons 1–5.

USER button	Corresponding setting
USER1 to USER3	[1] to [3]
USER4	[INIT]
USER5	[EXIT]

- When using Focus Transition, functions registered to the USER buttons 1–5 do not work with the USER buttons.

To set the Focus Transition time

- Switch to Manual Mode. (→ 34)

1 Select the menu.

 : [CAMERA SETUP] → [FOCUS TRANSITION TIME]

2 Touch the desired setting item.

[DIRECT]/[2-15 SEC.]/[20 SEC.]/[30 SEC.]/[45 SEC.]/[60 SEC.]/[90 SEC.]

- When [DIRECT] is set, a focus position changes as soon as Focus Transition starts.

3 (If you have selected [2-15 SEC.] in Step 2)

Touch  /  to set the duration.

- You can set a Focus Transition time of 2–15 seconds (by 0.5 second increments)
- Touch [ENTER]

4 Touch [EXIT] to complete the setting.

To start Focus Transition and recording simultaneously

You can start Focus Transition and recording simultaneously by enabling [FOCUS TRANSITION REC].

- Switch to Manual Mode. (→ 34)

1 Select the menu.

 : [CAMERA SETUP] → [FOCUS TRANSITION REC]

2 Touch the item.

[1]/[2]/[3]

3 Touch [EXIT] to complete the setting.

4 When the recording screen is displayed, press the USER button to which [FOCUS TRANSITION] is registered or press the applicable USER button icon.

5 Press the recording start/stop button.

- Recording and Focus Transition will start simultaneously. Focus will shift to the position you have set in Step 2.

To set the length of time before Focus Transition starts

- Switch to Manual Mode. (→ 34)

 : [CAMERA SETUP] → [FOCUS TRANSITION WAIT] → desired time

[0 SEC.]/[5 SEC.]/[10 SEC.]



White Balance

Automatic White Balance function may not reproduce natural colours depending on the scenes or lighting conditions. If so, you can adjust the White Balance manually.

- Use the multi-function dial to change the settings.

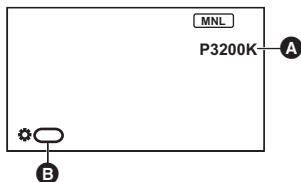

- A** White Balance
- In Auto White Balance Mode, [ATW] is displayed.
- B** [WB]

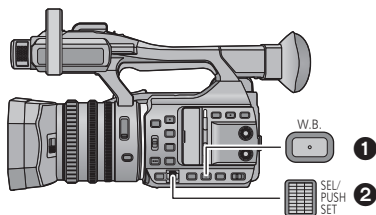

- 1** W.B. button
- 2** Multi-function dial

- Switch to Manual Mode. (→ 34)

1 Press the W.B. button to switch to the Manual White Balance Mode.

- The White Balance mode will switch to the one you set previously.

2 Rotate the multi-function dial to switch the White Balance mode.

- The mode will be switched in the following order:
P3200k ↔ P5600k ↔ VAR ↔ Ach ↔ Bch.



About White Balance modes

Mode	Settings
ATW (ATW) ^{*1}	It will automatically adjust in accordance with the recording condition.
LOCK (ATW Lock) ^{*2}	It will lock the setting for ATW. (→ 47)
P3200k (P3200k) ^{*3}	Preset value for studio/indoor recording (halogen lamp, etc.)
P5600k (P5600k) ^{*3}	Preset value for outdoors
VAR (VAR) ^{*3}	Setting can be finely adjusted in accordance to the recording conditions. (→ 47)
Ach (Ach) ^{*3} Bch (Bch) ^{*3}	Setting in accordance to the recording scenes can be set. (→ 47)

- *1 This mode is used for Auto White Balance Mode and Intelligent Auto Mode.
- *2 You can set this mode with a USER button.
- *3 Only displayed when Manual White Balance Mode is in use.
- To return to Auto White Balance Mode, press the W.B. button or set this unit to Intelligent Auto Mode using the iA/MANU switch.

■ To set ATW Lock

You can set ATW Lock by registering [ATW LOCK] to a USER button.

- Please refer to page 61 for details about setting the USER button.
- 1 Set the White Balance mode to [ATW].**
 - If a mode other than [ATW] is set, press the W.B. button.
- 2 Press the USER button to which [ATW LOCK] is registered or touch the applicable USER button icon.**
 - To cancel ATW Lock, press the USER button or touch the USER button icon again. Cancelling ATW Lock will return the White Balance mode back to [ATW].

- ATW Lock is not available except when the White Balance mode is set to [ATW].
- It will be cancelled when the unit is turned off.

■ To finely adjust the White Balance

It is possible to adjust the White Balance in increments of 100K. A value between P2400K and P9900K can be set.

- Use the multi-function dial to change the settings.
- **Switch to Manual Mode. (→ 34)**

- 1 Set the White Balance mode to [VAR]. (→ 46)**
- 2 Push the multi-function dial.**
- 3 Rotate the multi-function dial to adjust the colour balance.**
- 4 Push the multi-function dial to finish the adjustment.**



■ To set the White Balance in accordance to the recording scene

- 1 Fill the screen with a white subject or place a white piece of paper in front of the lens.**
- 2 Set the White Balance mode to [Ach] or [Bch]. (→ 46)**
- 3 Press and hold the W.B. button or the multi-function dial to start adjusting the White Balance.**
 - The screen goes dark momentarily, "WB SET OK" is displayed, and the adjustment ends.

- When the mode of White Balance is set to something other than [Ach] or [Bch], the Black Balance adjustment is performed by pressing and holding the W.B. button or the multi-function dial. Setting is completed when the screen goes black momentarily and "BB SET OK" is displayed.
- When the White Balance/Black Balance cannot be performed, an error message "WB SET NG" or "BB SET NG" is displayed on the screen. In such case, use other mode.
- Settings assigned to [Ach] or [Bch] can be finely adjusted in [COLOUR TEMP A ch]/[COLOUR TEMP B ch]. (→ 134)
- The contents previously set are maintained in the [Ach] or [Bch]. Perform the setting again when the recording condition has changed.



Iris/Gain adjustment

When recording a scene that is too dark (or bright) or a scene in a similar situation, manually adjust the iris and gain.

Iris adjustment

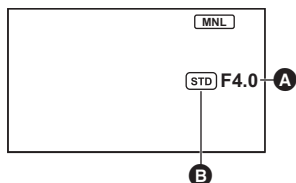

- A** Iris value
- B** Auto iris icon*
- * It is displayed in Auto Iris Mode.

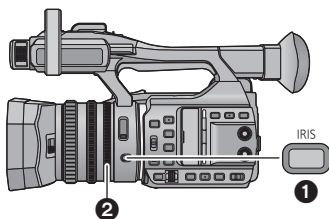

- 1** IRIS button
- 2** Iris ring

- Switch to Manual Mode. (→ 34)

1 Press the IRIS button to switch to Manual Iris Mode.

- **STD** disappears.

2 Adjust the iris by rotating the iris ring.

Iris value:

CLOSE ↔ (F11 to F1.9) ↔ **OPEN**

- Value closer to CLOSE darkens the image.
- Value closer to OPEN brightens the image.
- To return to Auto Iris Mode, press the IRIS button or set this unit to Intelligent Auto Mode using the iA/MANU switch.

-
- Depending on the zoom magnification, there are iris values that are not displayed.
 - In Auto Gain Mode or Auto Shutter Mode, the screen brightness may not change even if you adjust the iris. (→ 49, 51)

■ Adjusting brightness during the Auto Iris Mode

- Switch to Manual Mode. (→ 34)

1 Select the menu.

 : [CAMERA SETUP] → [AUTO IRIS LEVEL]

2 Touch  /  to adjust settings.

3 Touch [EXIT] to complete the setting.

Utilizing the USER button

It is convenient to use following functions of the USER button when it is set to Iris adjustment.

- Please refer to page 61 for details about setting the USER button.

USER button function	Effect
Backlight Compensation (→ 64)	Switches to automatic iris control to compensate the backlight. This will brighten the image on the screen to prevent getting dark when a backlight is hitting the subject from the back.
Spotlight (→ 64)	Switches to automatic iris control for spotlight. This will allow to clearly record an extremely bright subject.

Gain adjustment

- Use the multi-function dial to change the settings.

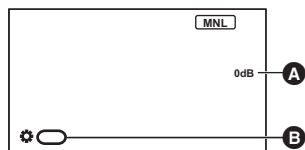

A Gain value

- In Auto Gain Mode, AGC is displayed; in Manual Gain Mode, the gain value is displayed in dB.

B [GAIN]

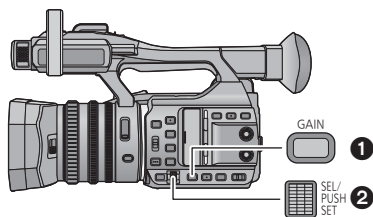

1 GAIN button

2 Multi-function dial

- Switch to Manual Mode. (→ 34)

1 Press the GAIN button to switch to Manual Gain Mode.

- The gain value will be displayed in dB.

2 Adjust the gain by rotating the multi-function dial.

Gain value:

0dB to 24dB

- Value closer to 0dB darken the image.
- Value closer to 24dB brighten the image.



- To return to Auto Gain Mode, press the GAIN button or set this unit to Intelligent Auto Mode using the iA/MANU switch.
- If you register [SUPER GAIN] to a USER button, you can set the gain value to 27 dB or 30 dB. (→ 50)

-
- If the gain value is increased, the noise on the screen increases.
 - In Auto Iris Mode or Auto Shutter Mode, the screen brightness may not change even if you adjust the gain. (→ 48, 51)

■ Changing the maximum possible gain value for Auto Gain Mode

- Switch to Manual Mode. (→ 34)

 : [CAMERA SETUP] → [AGC LIMIT] → desired setting

[3dB]/[6dB]/[9dB]/[12dB]/[15dB]/[18dB]/[21dB]/[24dB]

-
- The value is set to [24dB] In Intelligent Auto Mode.

Super Gain

You can use Super Gain by registering [SUPER GAIN] to a USER button. Super Gain allows you to set the gain value to 27 dB or 30 dB.

- Please refer to page 61 for details about setting the USER button.

- Switch to Manual Mode. (→ 34)

Press the USER button to which [SUPER GAIN] is registered or touch the applicable USER button icon.

- To cancel Super gain, press the USER button or touch the USER button icon again.

To change the gain value of Super Gain

 : [CAMERA SETUP] → [SUPER GAIN] → desired setting

[27dB]/[30dB]

-
- Super Gain is not available in the following cases:
 - In Intelligent Auto Mode
 - When [INFRARED REC] is set to [ON] (→ 146)



Manual shutter speed

Adjust the shutter speed when recording fast-moving subjects.

- Use the multi-function dial to change the settings.

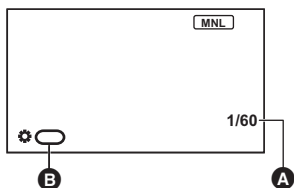

- A** Shutter speed
 - This is displayed in Manual Shutter Mode.
- B** [SHUTTER]

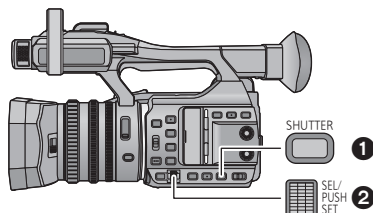

- 1** SHUTTER button
- 2** Multi-function dial

- Switch to Manual Mode. (→ 34)

1 Press the SHUTTER button to switch to Manual Shutter Mode.

2 Adjust the shutter speed by rotating the multi-function dial.

- To return to Auto Shutter Mode, press the SHUTTER button or set this unit to Intelligent Auto Mode using the iA/MANU switch.



Shutter speed:

The shutter speed varies depending on the frame rate in [REC FORMAT]. (→ 139)

Frame rates in [REC FORMAT]	Shutter speed
50p/50i/25p	1/50.0* ↔ 1/6 ↔ 1/12 ↔ 1/25 ↔ 1/50 ↔ 1/8000
60p/60i	1/60.0* ↔ 1/8 ↔ 1/15 ↔ 1/30 ↔ 1/60 ↔ 1/8000
30p	1/60.0* ↔ 1/8 ↔ 1/15 ↔ 1/30 ↔ 1/50 ↔ 1/8000
24p	1/48.0* ↔ 1/6 ↔ 1/12 ↔ 1/24 ↔ 1/48 ↔ 1/8000

* Synchro Scan values (→ 52)

- The shutter speed closer to 1/8000 is faster.

- You may see a band of light around an object that is shining very bright, or highly reflective.
- During normal playback, image movement may not look smooth.
- If you record an extremely bright object or record under indoor lighting, colour and screen brightness may change or a horizontal line may appear on the screen. In such cases, change settings as follows:
 - Set this unit to Intelligent Auto Mode.
 - Adjust the shutter speed to 1/50, 1/60 or 1/100.
 - Adjust the Synchro Scan setting
- In Auto Iris Mode or Auto Gain Mode, the screen brightness may not change even if you adjust the shutter speed. (→ 48, 49)

Making adjustments with Synchro Scan

If you press the multi-function dial when the shutter speed is displayed as a decimal number, the Synchro Scan setting will be displayed. You can fine-adjust the shutter speed by adjusting the Synchro Scan setting.

1 Press the SHUTTER button

2 When the shutter is displayed as a decimal number (e.g., 1/60.0), press the multi-function dial.

- The display on the screen will switch from [⚙️ SHUTTER] to [⚙️ SYNCHRO], and the Synchro Scan setting will be displayed.



3 Adjust the Synchro Scan setting by rotating the multi-function dial.

- You can adjust the setting faster by rotating the multi-function dial while pushing and holding it.
- To minimise flickering and horizontal bands, look at the screen while adjusting the shutter speed.

4 Push the multi-function dial to set.

Shutter speed range for the Synchro Scan setting

The shutter speed range varies depending on the frame rate in [REC FORMAT]. (→ 139)

Frame rates in [REC FORMAT]	Shutter speed
50p/50i	1/50.0 to 1/250.0
25p	1/25.0 to 1/250.0
60p/60i	1/60.0 to 1/249.8
30p	1/30.0 to 1/249.8
24p*	1/24.0 to 1/249.8
[C4K/24p 100M]	1/24.0 to 1/250.0

* Except for when [REC FORMAT] is set to [C4K/24p 100M].



Audio Input

This unit can record audio in 2 ch.

It is possible to switch between built-in microphone, external microphone, or connected audio equipment for each channel.

■ About audio recording methods

The audio recording method varies depending on the [REC MODE] setting. (→ 139)

Recording mode	Audio recording method
MOV (LPCM)	Linear PCM (LPCM)
MP4 (LPCM)	
MP4	AAC
AVCHD	Dolby Digital ()

Switching Audio Input

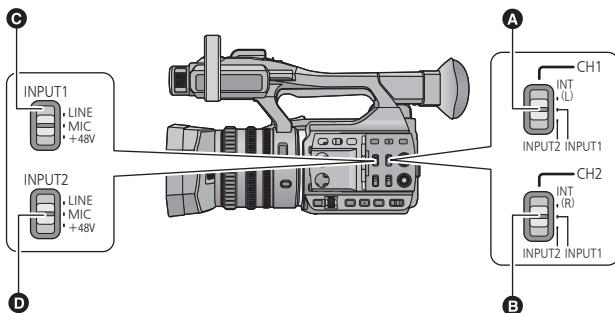

- A** CH1 switch
- B** CH2 switch
- C** INPUT1 switches
- D** INPUT2 switches

■ Using the built-in microphone

Audio is recorded with the built-in microphone (2 ch) when the CH1 switch is set to INT(L) and the CH2 switch is set to INT(R).

■ Using an external microphone or audio equipment

- 1 Connect an external microphone or audio equipment to **AUDIO INPUT1, 2** terminals (XLR 3 pin). (→ 12)
- 2 Use **INPUT1** or **INPUT2** switches to switch the connected audio input signal.

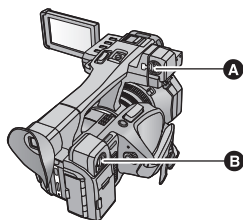

- A** AUDIO INPUT1 terminal (XLR 3 pin)
- B** AUDIO INPUT2 terminal (XLR 3 pin)

LINE^{*1}: Audio equipment is connected

MIC^{*2}: An external microphone is connected

+48V^{*2}: When using a phantom microphone (which requires a power supply of +48 V)

*1 The input level varies depending on the [INPUT1 LINE LEVEL] or [INPUT2 LINE LEVEL] setting. (→ 149)

*2 The input level varies depending on the [INPUT1 MIC LEVEL] or [INPUT2 MIC LEVEL] setting. (→ 150)

- 3 Use the **CH1** switch to select the input signal to be recorded to audio channel 1.

INT(L): Audio from the built-in microphone L (left) ch is recorded to audio channel 1.

INPUT1: Audio from a device connected to audio input terminal 1 (XLR 3 pin) is recorded to channel 1.

INPUT2: Audio from a device connected to audio input terminal 2 (XLR 3 pin) is recorded to channel 1.

- 4 Use the **CH2** switch to select the input signal to be recorded to audio channel 2.

INT(R): Audio from the built-in microphone R (right) ch is recorded to audio channel 2.

INPUT1: Audio from a device connected to audio input terminal 1 (XLR 3 pin) is recorded to channel 2.

INPUT2: Audio from a device connected to audio input terminal 2 (XLR 3 pin) is recorded to channel 2.

■ Table of audio input patterns

Switch setting		Channel or terminal used for signal input	
CH1 switch	CH2 switch	Audio channel 1	Audio channel 2
INT(L)	INT(R)	Internal microphone Lch	Internal microphone Rch
	INPUT1	Internal microphone Lch	AUDIO INPUT1 terminal
	INPUT2	Internal microphone Lch	AUDIO INPUT2 terminal
INPUT1	INT(R)	AUDIO INPUT1 terminal	Internal microphone Rch
	INPUT1	AUDIO INPUT1 terminal	AUDIO INPUT1 terminal
	INPUT2	AUDIO INPUT1 terminal	AUDIO INPUT2 terminal
INPUT2	INT(R)	AUDIO INPUT2 terminal	Internal microphone Rch
	INPUT1	AUDIO INPUT2 terminal	AUDIO INPUT1 terminal
	INPUT2	AUDIO INPUT2 terminal	AUDIO INPUT2 terminal

To remove the external microphone, etc., from the audio input terminals 1, 2 (XLR 3 pin)

Remove while pushing on the PUSH section of the audio input terminals 1, 2 (XLR 3 pin).

- Set the input signal to built-in microphone by switching the CH1, CH2 switches to INT (L) or INT (R) after removing the external microphone. Audio will not be recorded when motion picture is recorded without switching.

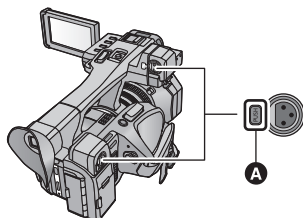

A PUSH section

- Set INPUT1, 2 (+48V) switches to LINE or MIC if you connect equipment not compatible with +48 V. You can damage this unit or such equipment if you leave the setting at +48V.
- This unit is turned off when a problem occurs with the +48 V power supply.
- The battery will discharge faster if you use a phantom microphone.

Adjusting the audio input level

Selecting an adjustment method

You can select how to adjust the audio input level. For audio channel 1, select [AUDIO LEVEL CH1]; for audio channel 2, select [AUDIO LEVEL CH2].

1 Select the menu.

 : [RECORD SETUP] → [AUDIO LEVEL CH1] or [AUDIO LEVEL CH2] → desired setting

[AUTO]: Adjusts the level automatically.

[MANUAL]: Adjusts the level manually.

2 (If you have touched [MANUAL])

Adjust the input level operating the Audio control knobs (CH1, CH2)

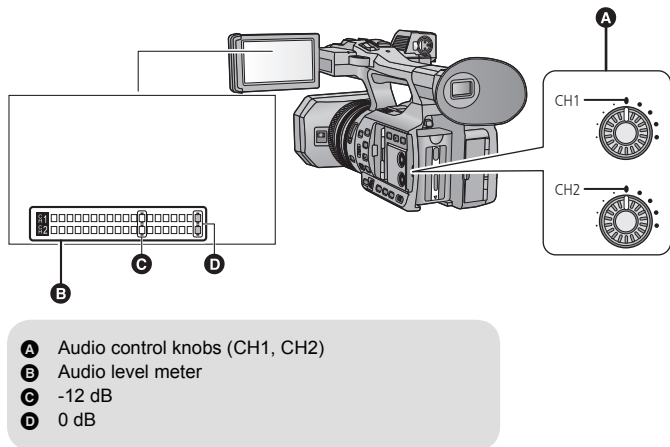

- Adjust confirming the audio level meter.

Using the ALC function

ALC can reduce audio noise. For audio channel 1, select [AUDIO ALC CH1]: for audio channel 2, select [AUDIO ALC CH2].

Select the menu.

MENU : [RECORD SETUP] → [AUDIO ALC CH1] or [AUDIO ALC CH2] → desired setting

[ON]: Enables ALC, allowing you to record audio with reduced noise.

[OFF]: Allows you to record natural-sounding audio.

■ To set the ALC function to both audio channels 1 and 2

If you set [AUDIO ALC LINKED] to [ON], when ALC works for either of the audio channels, it will also work for the other audio channel.

- 1 Set [AUDIO LEVEL CH1]/[AUDIO LEVEL CH2] to [MANUAL]. (→ 55)
- 2 Set [AUDIO ALC CH1]/[AUDIO ALC CH2] to [ON].
- 3 Select the menu.

MENU : [RECORD SETUP] → [AUDIO ALC LINKED] → [ON]

Counter display

You can change a counter display that indicates how much time has elapsed during recording or playback.

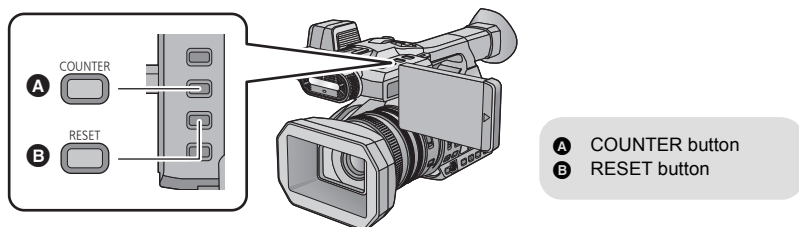

Press the COUNTER button to switch the counter display.

- The display will be switched in the following order: Time Code → User Information* → Recording Counter → Off.

Counter display	Indications
Time Code	TC 00:00:00:00 or TC 00:00:00.00 <ul style="list-style-type: none"> • Display will change depending on the setting of the [TC MODE]. (→ 58)
User Information* (→ 59)	UB 00 00 00 00
Recording Counter (→ 60)	(In Recording Mode) 0:00:00 or SCN 0:00:00 (In Playback Mode) SCN 0:00:00 <ul style="list-style-type: none"> • In Recording Mode, display will change depending on the setting of the [REC COUNTER]. • In Playback Mode, display will return to SCN 0:00:00 for each scene.

* This is displayed only when [REC MODE] is set to [AVCHD]. (→ 139)

Setting the Time Code

Time code will display the recording time in hours, minutes, seconds, and frames.

TC 00:00:00:00 (hour : minute : second : frame [NDF])

TC 00:00:00.00 (hour : minute : second . frame [DF])

- The number of frames (frame count per second) varies depending on the frame rate in [REC FORMAT]. (→ 139)

Frame rates in [REC FORMAT]	Frame
50p/50i/25p	0 to 24
60p/60i/30p	0 to 29
24p	0 to 23

[TC MODE]



Select the compensation mode for the time code.

- Set [SYSTEM FREQ] to [59.94Hz(NTSC)]. (→ 159)



[TC/UB SETUP] → [TC MODE] → desired setting

[DF]:

Time code is compensated in accordance with the actual time. It is mainly used for broadcasting such as TV programs.

[NDF]:

It will not compensate the time code. (There will be a difference from the actual time)

- When the frame rate in [REC FORMAT] is 24p or during Time Lapse Recording, this item will be set to [NDF] automatically.
- This item will be automatically set to [NDF] and will not be displayed as a menu item when [SYSTEM FREQ] is set to [50Hz(PAL)]. (→ 159)

[TCG]



Sets the way the time code will move.



[TC/UB SETUP] → [TCG] → desired setting

[FREE RUN]*:

It will constantly move.

[REC RUN]:

It will move only when recording.

* If the frame rate in [REC FORMAT] is set to 24p, a slight time error may occur when switching to Playback Mode.

- It is automatically set to [FREE RUN] when PRE-REC is enabled or [2 SLOTS FUNC.] (→ 143) is set to [BACKGROUND].
- It is automatically set to [REC RUN] when it is during the Interval Recording.

-
- The time code will reset when the built-in lithium battery is exhausted when it is set to [FREE RUN].

[TC PRESET]

You can set the initial time code.

1 Select the menu.

 : [TC/UB SETUP] → [TC PRESET]

2 Touch the item to set and change with / .

- It will be set to 00h00m00s00f when the RESET button is pressed.
- "h" is an abbreviation for hour, "m" for minute, "s" for second and "f" for frame.

3 Touch [ENTER].

- Touch [EXIT] to complete the setting.

-
- This unit will adjust the time code in accordance with the frame rate of the [REC FORMAT]. (→ 139) Therefore, it may not be continuous from the previous final time code when the recording format is changed.
 - If the frame rate in [REC FORMAT] is set to 24p, set the number of frames to [00] or a multiple of 4. If you enter a different value, time code will not be recorded correctly.

Setting the User Information

Eight digit hexadecimal alphanumeric can be entered and displayed as a memo information such as dates, control numbers, etc., into the User Information.

UB 00 00 00 00

- This is displayed only when [REC MODE] is set to [AVCHD]. (→ 139)

[UB PRESET]

You can set the User Information.

- Set [REC MODE] to [AVCHD]. (→ 139)

1 Select the menu.

 : [TC/UB SETUP] → [UB PRESET]

2 Touch the item to set and change with / .

- You can use numbers from 0 to 9 and letters from A to F.
- It will be set to 00 00 00 00 when the RESET button is pressed.

3 Touch [ENTER].

- Touch [EXIT] to complete the setting.

Setting the Recording Counter

Recording Counter will display the recording time in seconds.

0:00:00 (hour : minute : second (When [REC COUNTER] is set to [TOTAL]))

SCN 0:00:00 (hour : minute : second (When [REC COUNTER] is set to [SCENE]))

[REC COUNTER]



Select the counting method during the recording.

MENU



[DISP SETUP] → [REC COUNTER] → desired setting

[TOTAL]:	The count continues to increase until the Recording Counter is reset.
[SCENE]:	Resets the Recording Counter at start of recording. Counts the time of each recording session.

To reset the Recording Counter for the Recording Mode

The Recording Counter will be set to 0:00:00 when the RESET button is pressed while displaying the counter.



USER button

Each of the USER button can register one function from the 24 available functions.

- There are six USER buttons (USER1 to USER6) on the main body and four USER button icons (USER7 to USER10) displayed on the LCD monitor.

Setting the USER button

1 Select the menu.

MENU : [DRS] → [USER BUTTON SETUP]

2 Touch the USER button you wish to set.



- The USER button number and currently set function name are displayed. (For example, a display of 1. [DRS] means that [DRS] has been assigned to USER1 button.)

3 Touch the item to register.

- For the functions of the USER button that can be registered, refer to page 63.
- Touch [INH] (Inhibit) if not registering.
- Next (Previous) page can be displayed by touching / .
- To continuously set other USER buttons, repeat Steps 2-3.

4 Touch [EXIT] to complete the setting.

- The tables below show the default settings.

USER1 button	[DRS]
USER2 button	[D.ZOOM]
USER3 button	[BACKLIGHT]
USER4 button	[Wi-Fi]
USER5 button	[FOCUS ASSIST]

USER6 button	[REC CHECK]
USER7 button	[FRZ FRAME]
USER8 button	[EVF/LCD DETAIL]
USER9 button	[ATW LOCK]
USER10 button	[MENU]

- Performing [INITIAL SET] in [ALL] restores these default settings. (→ 160)
- The default setting for the USER5 button is [FOCUS ASSIST].
If you change the user button function for the USER5 button, a newly registered USER button function will work instead of the Focus Assist function.
- The default setting for the USER6 button is [REC CHECK].
If you change the user button function for the USER6 button, a newly registered USER button function will work instead of the Recording Check function.

Using the USER button

To use the set USER button, press USER1 to USER6 button or touch the USER7 to USER10 button icon displayed when you touch the LCD monitor.

(When you use the USER1 to USER5 button)

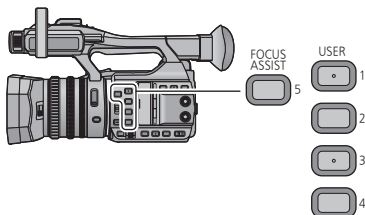

(When you use the USER6 button)

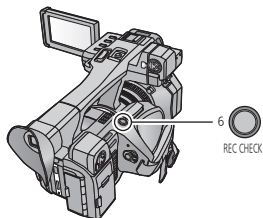

(When you use the USER7 to USER10 button)

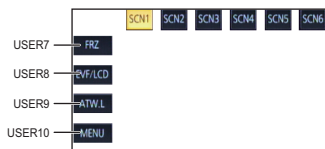

- To cancel, press the USER button or touch the USER button icon again.

For cancelling or using of the following functions for the USER buttons, refer to each page.

- Black Fade (→ 64)
- White Fade (→ 64)
- Digital Zoom (→ 65)
- Recording Check (→ 66)
- Last Scene Delete (→ 66)
- Area Mode (→ 68)
- Focus Transition (→ 43)
- Background (→ 71)

■ Switch display/not-display of the USER buttons

Display/not-display of the USER button icons in the LCD monitor can be switched.

: [DISP SETUP] → [USER BUTTON DISPLAY] → [ON] or [OFF]

■ Check the setting of the USER buttons

To check the settings of the USER buttons (USER1 to USER6) in the recording screen, press and hold on the DISP/MODE CHK button.

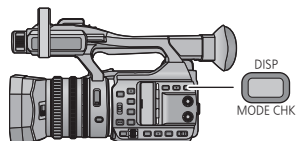

Functions of the USER button

■ List of USER button function

Icon	Item	Function
[FA]	[FOCUS ASSIST]	Focus Assist
[B.Light]	[BACKLIGHT]	Backlight Compensation
[S.Light]	[SPOTLIGHT]	Spotlight
[B.FD]	[BLACK FADE]	Black Fade
[W.FD]	[WHITE FADE]	White Fade
[EVF/LCD]	[EVF/LCD DETAIL]	EVF/LCD detail
[ATW.L]	[ATW LOCK]	ATW Lock
[D.ZM]	[D.ZOOM]	Digital Zoom
[HIST]	[HISTOGRAM]	Histogram
[REC.C]	[REC CHECK]	Recording Check
[LstDel]	[LAST SCN DEL]	Last Scene Delete
[DRS]	[DRS]	DRS*
[FRZ]	[FRZ FRAME]	Freeze Frame
[S.Gain]	[SUPER GAIN]	Super Gain*
[AREA]	[AREA]	Area Mode*
[F.Tran]	[FOCUS TRANS]	Focus Transition*
[Capture]	[CAPTURE]	Capture
[Wi-Fi]	[Wi-Fi]	Wi-Fi
[IR Light]	[IR LIGHT]	Infrared light*
[Level]	[LEVEL GAUGE]	Level Gauge
[Backgr]	[BACKGROUND]	Background
[FBC]	[FLASH BAND]	Flash band compensation*
[MENU]	[MENU]	Menu

* These functions are not available in Intelligent Auto Mode.

● The following USER button function can also be set from the menu.

- [HISTOGRAM] (→ 66)
- [DRS] (→ 67)
- [IR LIGHT] (→ 69)
- [LEVEL GAUGE] (→ 70)
- [EVF/LCD DETAIL] (→ 65)
- [FLASH BAND] (→ 71)

Focus Assist

- Register “Focus Assist” to a USER button. (→ 61)

You can set the Focus Assist. (→ 40)

Backlight Compensation

- Register “Backlight Compensation” to a USER button. (→ 61)

Switches to automatic iris control to compensate the backlight.

This makes the image brighter to prevent darkening of a backlit subject.



-  appears when it is set.
- It will return to standard Auto Iris Mode () when it is cancelled. (→ 48)

Spotlight

- Register “Spotlight” to a USER button. (→ 61)

Switches to automatic iris control for spotlight.

Very bright object is recorded clearly.

-  appears when it is set.
- It will return to standard Auto Iris Mode () when it is cancelled. (→ 48)

Black Fade

- Register “Black Fade” to a USER button. (→ 61)

Fade in/fade out effect (black) can be added to the video and audio that is being recorded.

Press USER button or touch USER button icon in the recording screen.

- Fade out will start, and fade in will start after completing the fade out.
- It will fade out when the button is pressed and held, and fade in will start when the button is released.

-
- Recording will not start even if the fade out is started. It is possible to press the recording start/ stop button during the fade in or fade out.
 - This effect cannot be set for Interval Recording.
 - The thumbnails of scenes recorded using fade in become black.

White Fade

- Register “White Fade” to a USER button. (→ 61)

Fade in/fade out effect (white) can be added to the video and audio that is being recorded.

Press USER button or touch USER button icon in the recording screen.

- Fade out will start, and fade in will start after completing the fade out.
- It will fade out when the button is pressed and held, and fade in will start when the button is released.

-
- Recording will not start even if the fade out is started. It is possible to press the recording start/ stop button during the fade in or fade out.
 - This effect cannot be set for Interval Recording.
 - The thumbnails of scenes recorded using fade in become white.

EVF/LCD detail

- Register “EVF/LCD detail” to a USER button. (→ 61)

[EVF/LCD DETAIL] helps you achieve focus easier by emphasizing the outlines of an image displayed on the LCD monitor or the viewfinder. (→ 40)

- These settings will not affect the images actually recorded.

ATW Lock

- Register “ATW Lock” to a USER button. (→ 61)

The White Balance can be changed to ATW Lock. (→ 47)

Digital Zoom

- Register “Digital Zoom” to a USER button. (→ 61)

Press USER button or touch USER button icon in the recording screen.

- When [DIGITAL ZOOM] is set to [×2], [×5] or [×10], Digital Zoom will be turned on/off each time you press the button.
- When [DIGITAL ZOOM] is set to [TOGGLE], the zoom magnification will change each time you press the button.
2× → 5× → 10× → Setting cancelled

■ To change the zoom magnification of Digital Zoom

The zoom magnification of Digital Zoom varies depending on the [DIGITAL ZOOM] setting.



[RECORD SETUP] → [DIGITAL ZOOM] → desired setting

[×2]:	Sets the zoom magnification to 2×.
[×5]:	Sets the zoom magnification to 5×.
[×10]:	Sets the zoom magnification to 10×.
[TOGGLE]:	Changes the zoom magnification each time you press the applicable USER button.

- When using Digital Zoom, the larger you set the zoom magnification, the lower the picture quality becomes.
- Digital Zoom is not possible in following cases:
 - During the Interval Recording
 - When using Area Mode
 - During Freeze Frame (→ 67)
- Digital zoom is cancelled in following cases:
 - If you turn the unit off
 - If you press the THUMBNAIL button

Histogram

- Register “Histogram” to a USER button. (→ 61)

A graph with brightness as horizontal axis and number of pixels at that brightness as vertical axis is displayed. It is possible to determine the exposure of the whole image by looking at the distribution in the graph.

■ To move a histogram

You can move a histogram by touching and holding the histogram display **A**. Slide the display while touching it to move it to the desired display location.

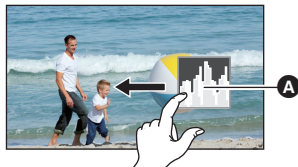

- To adjust the brightness, refer to page 48.

Recording Check

- Register “Recording Check” to a USER button. (→ 61)

Approximately 2 seconds at the end of the video recorded last can be played back. It will return to recording screen once the playback is completed.

- Playback operation is not possible during the Recording Check.
- Recording Check is not possible in following cases:
 - When the unit is turned on/off
 - When the THUMBNAIL button is pressed
 - When the setting of [REC FORMAT] is changed
 - When the SD Card is inserted/removed
 - During the Interval Recording
 - Set [2 SLOTS FUNC.] to [SIMULTANEOUS] or [BACKGROUND] (→ 143)
 - During Freeze Frame (→ 67)

Last Scene Delete

- Register “Last Scene Delete” to a USER button. (→ 61)

The motion picture recorded last can be deleted.

Deleted scenes cannot be restored.

1 Press USER button or touch USER button icon in the recording screen.

2 Touch [YES].

- It will return to recording screen without deleting by touching [NO].
- Last Scene Delete is not possible in following cases:
 - When the unit is turned on/off
 - When the THUMBNAIL button is pressed
 - When the setting of [REC FORMAT] is changed
 - When the SD Card is inserted/removed
 - During the Interval Recording
 - Set [2 SLOTS FUNC.] to [SIMULTANEOUS] or [BACKGROUND]. (→ 143)

DRS

- Register “DRS” to a USER button. (→ 61)
- Switch to Manual Mode. (→ 34)

Selects the DRS (Dynamic Range Stretcher) function.

It is possible to expand the dynamic range by compressing the video signal level of the highly illuminated area that gets washed out with standard recording.

-
- If there are extremely dark or bright parts or the brightness is insufficient, the effect may not be clear.
 - It is also possible to adjust the compression level of the highly illuminated area by changing the [DRS EFFECT] setting. (→ 134)

Freeze Frame

- Register “Freeze Frame” to a USER button. (→ 61)

Freezes the image on the unit.

- [Freeze] will appear on the screen and flash.

-
- If you record a motion picture during Freeze Frame, the frozen image and sounds will be recorded.
 - You can perform the following camera operations during Freeze Frame. Other camera operations will be disabled.
 - Recording motion pictures
 - Cancelling Freeze Frame
 - Operating the FOCUS A/M/∞ switch
 - This function is not available in the following cases:
 - When using Focus Assist (→ 40)
 - During the Interval Recording
 - When colour bars are displayed. (→ 72)
 - Freeze Frame is cancelled in the following cases:
 - Turning off the unit
 - When the THUMBNAIL button is pressed
 - When [USB MODE] (→ 161) is set to [DEVICE] and this unit is connected to a PC or Blu-ray disc recorder with a USB Connection Cable.

Super Gain

- Register “Super Gain” to a USER button. (→ 61)
- Switch to Manual Mode. (→ 34)

Sets the gain value to 27 dB or 30 dB. (→ 50)

Area Mode

You can apply a variety of effects to the subject you touch.

■ Setting an Area Mode effect

You can select the following menu items to set an effect to be applied when you touch the subject.

 : [CAMERA SETUP] → [AREA MODE] → desired setting

[INH]:	Does not apply any effects of Area Mode.
[FOCUS]:	Optimises the focus automatically for the subject you touch
[IRIS]:	Optimises the iris automatically for the subject you touch.
[Y GET]:	Displays the luminance level of the subject you touch.
[FOCUS/IRIS]:	Optimises the focus and iris automatically for the subject you touch.
[FOCUS/Y GET]:	Optimises the focus automatically for the subject you touch and displays the luminance level of the subject.

■ Using Area Mode

● Register “Area Mode” to a USER button. (→ 61)

● Switch to Manual Mode. (→ 34)

1 Press the applicable USER button or touch the applicable USER button icon on the recording screen.

● Area Mode will be enabled and  will be displayed.

2 Touch the recording screen.

● The area frame will be displayed on the part you have touched. The effect of the selected menu item will be applied.

To turn off Area Mode

(With a USER button)

Press the USER button

(With a USER button icon)

1 Touch and hold the recording screen to display operation icons.

2 Touch the USER button icon.

To change the size of the area frame

You can rotate the multi-function dial to change the size of the area frame.

● The area frame is available in three sizes.

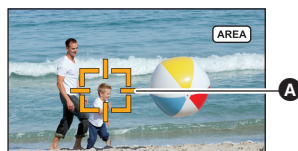

A Area frame

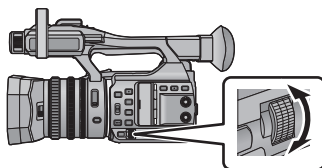

-
- Area Function is not possible in following cases:
 - In Intelligent Auto Mode
 - When a remote control (commercially-available) is connected (→ 6)
 - When using Area Mode, even if you turn on Marker by pressing the ZEBRA button, the luminance display frame will not be displayed. (→ 74)
In addition, the luminance level will not be displayed if [AREA MODE] is set to [FOCUS], [IRIS] or [FOCUS/IRIS].

Focus Transition

- Register “Focus Transition” to a USER button. (→ 61)
- Switch to Manual Mode. (→ 34)

With Focus Transition, you can move the current focus position to a pre-registered focus position. (→ 43)

Capture

- Register “Capture” to a USER button. (→ 61)

You can record still pictures or create still pictures from recorded motion pictures. (→ 32, 85)

Wi-Fi

- Register “Wi-Fi” to a USER button. (→ 61)

You can use the Wi-Fi function. (→ 111)

Infrared light

- Register “Infrared light” to a USER button. (→ 61)
- Switch to Manual Mode. (→ 34)

You can turn on/off the infrared light when [INFRARED REC] (→ 146) is set to [ON].

Level Gauge

- Register “Level Gauge” to a USER button. (→ 61)

This function displays the horizontal/vertical tilt of the unit with the electronic level.

■ To correct the tilt

(Horizontal direction)

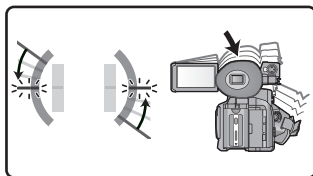

When correcting the leftward tilt

(Vertical direction)

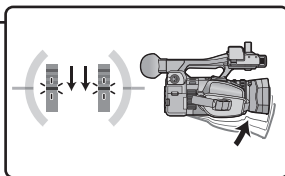

When correcting the downward tilt

- The horizontal tilt display **A** and vertical tilt display **B** appear yellow when there is a tilt, and appear green when there is almost no tilt.
- The maximum tilt display angles are approximately 45 ° in horizontal direction and 10 ° in vertical direction.
- The electronic level does not affect the actual recorded images.

-
- This function is not available in the following cases:
 - During Freeze Frame (→ 67)
 - When colour bars are displayed. (→ 72)
 - If [SELF SHOOT] (→ 156) is set to [MIRROR], the electronic level will not be displayed when you record yourself.
 - Even when the tilt is in the corrected state, an error of approximately 1 ° may occur.
 - In the following cases, the electronic level may not be displayed correctly:
 - When moving this unit
 - When pointing this unit up or down at an angle closer to perpendicular

Background

- **Register “Background” to a USER button. (→ 61)**

When [2 SLOTS FUNC.] is set to [BACKGROUND], you can start/stop background recording.

- When the recording destination of motion pictures is set to [SD CARD 1] in [MEDIA SELECT] (→ 30), [SD CARD 2] will be used for background recording.

The following instructions assume that the recording destination of motion pictures is set to [SD CARD 1].

- **Set [2 SLOTS FUNC.] to [BACKGROUND]. (→ 143)**

 is displayed beside the SD card display for card 2.

(To start background recording)

Press the applicable USER button or the USER button icon.

- Background recording will start on the SD card in card slot 2. ( will be displayed in red.)

(To stop background recording)

While motion picture recording to [SD CARD 1] is stopped, press and hold the applicable USER button or the USER button icon.

-
- Please refer to page 143 about Background recording.

Flash band compensation

- **Register “Flash band compensation” to a USER button. (→ 61)**

- **Switch to Manual Mode. (→ 34)**

If you set this item to [ON], you can compensate for and reduce flash band, a phenomenon that creates markedly different levels of luminance between the top and bottom of the image when recording is performed in an environment where another camera is firing its flash.

- [FBC] appears on the screen.

-
- This function is not available in the following cases:
 - When the frame rate in [REC FORMAT] is 30p or 24p/25p
 - When using [DIGITAL ZOOM]
 - The setting will be turned off when you turn off this unit.
 - Manual Shutter Mode will be activated. This will fix the shutter speed to 1/60 or 1/50.

Menu

- **Register “Menu” to a USER button. (→ 61)**

The menu can be displayed.

Useful functions

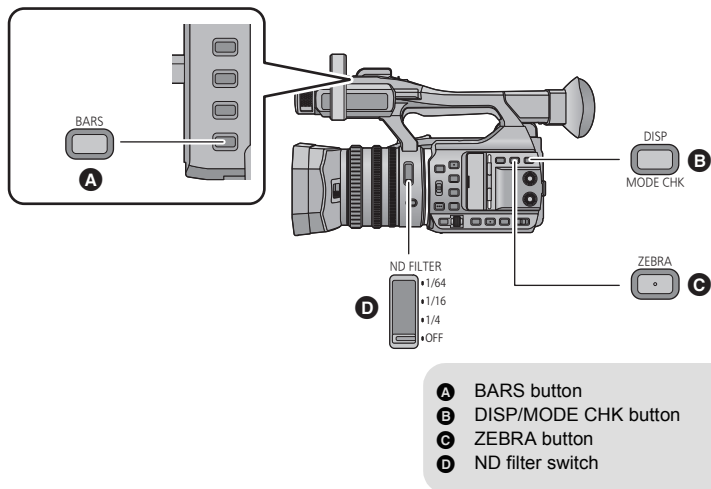

Colour Bar Screen

BARS button

Press the BARS button to output a colour bar screen to a television or monitor so you can adjust them.

- To cancel, press the BARS button again.
- It will be cancelled when the unit is turned off.
- While the colour bar is displayed, a test tone will be output from the headphone terminal, HDMI terminal and audio output terminal. It will not be output from the speaker of this unit.
- Different colour bars are displayed depending on the [BARS TYPE] setting. (→ 152)
- The frequency of a test tone that is output when colour bars are displayed differs depending on [SYSTEM FREQ] and the frame rate in [REC FORMAT]. (→ 139, 159)

System Frequency	Frame rates in [REC FORMAT]	Test tone frequency
59.94Hz(NTSC)	All recording format	1 kHz
50Hz(PAL)	24p	
	50p/50i/25p	997 Hz

- The test tone volume differs depending on the [TEST TONE] setting. (→ 157)
- You can record colour bars as motion pictures, but not as still pictures.
- If you press the BARS button while recording colour bars as a motion picture, you can stop displaying the colour bars. To display them again, stop the recording and press the BARS button.

ND filter

Using the ND filter switch, you can switch the built-in optical ND filter setting. (The filter adjusts the amount of light.)

- Use this function when recording a bright subject outdoors under a clear sky that causes the screen to look white.

- **Switch to Manual Mode.** (→ 34)

Slide the ND filter switch.

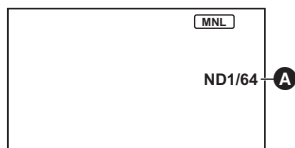

A ND filter setting

1/64:	Reduces the amount of light to 1/64.
1/16:	Reduces the amount of light to 1/16.
1/4:	Reduces the amount of light to 1/4.
OFF:	Does not use the ND filter.

- If the selected setting 1/64, 1/16 or 1/4 does not match an ND filter setting recommended by this unit, the recommended setting will be displayed on the screen, blink for approximately 5 seconds, and disappear.

- ND filter settings do not work in the following cases:
 - During Intelligent Auto Mode
 - When [INFRARED REC] is set to [ON] (→ 146)
- A recommend ND filter setting may not be displayed correctly in scenes that are too dark.

Zebra

ZEBRA button

It will switch between the zebra display and the marker display every time the button is pressed.
Zebra 1 → Zebra 2* → Marker* → setting cancelled

* It is not displayed when the [ZEBRA DETECT 2]/[MARKER] is set to [OFF]. (→ 153)

(When Zebra 1 is set)



(When Marker is set)

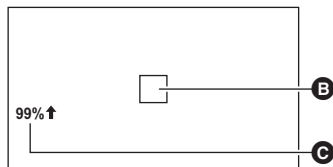

Zebra display:

Parts where white saturation (colour saturation) is likely to occur (extremely brightly lit or shiny parts) are displayed with diagonal lines (zebra pattern **A**).

Marker display:

Displays the luminance level of the centre of the screen (luminance display frame **B**) in %.

It makes the adjustment of the brightness of the object easier, by checking the luminance level of the object, when recording same object in different surroundings.

- Luminance level **C** is displayed between 0% and 99%. It will be displayed as 99%↑ when it is over 99%.

-
- You can record an image with little white saturation if you manually adjust the shutter speed or brightness. (→ 48, 51)
 - The zebra pattern does not appear on the images actually recorded.
 - It is also possible to adjust the level of the zebra pattern to be displayed. (→ 153)

Switching the screen indications/mode information display

DISP/MODE CHK button

All the screen display other than the Counter display, Time stamp*, Zebra display, Marker, Safety Zone will disappear when this button is pressed. (→ 164)

* When [DATE/TIME] is set to [TIME], [DATE], or [DATE&TIME]

- To cancel, press the DISP/MODE CHK button again.

■ To display the Mode Information

If you press and hold the DISP/MODE CHK button, the list of functions registered to the USER buttons (USER1 to USER6), the settings for [SUB REC BUTTON] and [SUB ZOOM], and a recommended ND filter setting are displayed.

- They are displayed only while the DISP/MODE CHK button is held. It is disappeared when the button is released.



Using Operation Icons

You can use convenient functions just by the easy operation of touching the screen.

1 Touch the LCD monitor in the recording screen.

- The operation icons are displayed.

2 Touch an operation icon.

- The following function is available. Refer to the respective pages for the operation.



SCN1, SCN2 etc.	Customise Scene (→ 132)*
Wi-Fi, MENU etc.	USER Button Icon (→ 61)

* It is not displayed in the Intelligent Auto Mode.

- If you touch the screen while an operation icon is being displayed or do not touch the icon for a certain period, it will disappear. To display again, touch the screen.

Using of multi-function dial

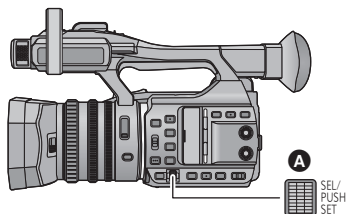

A Multi-function dial

Selecting/setting items

You can select and set menu items (→ 28), etc. using the multi-function dial.

1 Rotate the multi-function dial on the menu screen, etc., to move the cursor.

- The selected item will be displayed in yellow.



2 Push the multi-function dial to set.



Menu operations for setting a value

When a menu that lets you set a value is displayed, select the value display before adjusting the setting.

- You cannot select / / / with the multi-function dial when a screen that lets you adjust a value is displayed.

(Example: When adjusting the brightness for [LCD SET])

1 Rotate the multi-function dial to move the cursor to the value display **A**.

- Push the multi-function dial to select the value display.

2 Rotate the multi-function dial to adjust the setting.

- Pushing the multi-function dial will set the value you have selected.









- The multi-function dial also allows you to select/set operation icons, thumbnails, etc.
- Parts that are finger-touch sensitive can be operated with the multi-function dial. (Excluding some functions)



Using the multi manual function

You can select the following functions and adjust their settings using the multi-function dial. You can also switch between the functions and adjust their settings.

(When the recording screen is displayed)

On-screen icons	Functions	Settings
 GAIN	Gain adjustment (→ 49)	Adjusts the gain value.
 WB	White Balance (→ 46)	Changes the White Balance mode.
 SHUTTER	Shutter speed (→ 51)	Adjusts the shutter speed.
 AREA	Area Mode (→ 68)	Changes the area frame setting.
 ASSIST	Focus Assist (→ 40)	Changes the magnification level of the magnified display
 VOLUME	Headphone Volume Adjustment (→ 78)	Adjusts the headphone volume.
 ICONS	Allows you to display/select operation icons on the recording screen.	—

(When the playback screen is displayed)

On-screen icons	Functions	Settings
 VOLUME	Volume adjustment (→ 81)	Adjusts the speaker and headphone volume during motion picture playback.
 ICONS	Allows you to display/select operation icons on the playback screen.	—

To change the function you adjust

1 Change settings in advance so that you can select more than two functions.

- Change settings as follows:

Functions	Settings to be changed in advance
Gain adjustment	Press the GAIN button to enable Manual Gain Mode. (→ 49)
White Balance	Press the W.B. button to enable Manual White Balance Mode. (→ 46)
Shutter speed	Press the SHUTTER button to enable Manual Shutter Mode. (→ 51)
Area Mode	Press the applicable USER button to enable Area Mode. (→ 68)
Focus Assist	Set [FOCUS ASSIST] to [EXPAND] or [BOTH], and press the applicable USER button to enable Focus Assist. (→ 40)
Headphone Volume Adjustment	Connect headphones to this unit.

- The on-screen icon for the selected function is displayed in white. (Function Execution Mode)
If you have selected [⚙️ ICONS], you can rotate the multi-function dial to select an operation icon.

2 Push the multi-function dial.

- The on-screen icon turns yellow. (Function Selection Mode)

3 Rotate the multi-function dial to select the function you want to adjust, and press the multi-function dial to set the selection.

- The on-screen icon for the selected function turns white. (Function Execution Mode)
- You can rotate the multi-function dial to adjust the setting of the selected function.

■ Headphone Volume Adjustment

Adjust the volume of the headphone while recording.

- Set [VOLUME] to [ON]. (→ 157)

1 Connect headphones to the headphone terminal.

2 Rotate the multi-function dial to adjust the volume.

- Actual volume to be recorded does not change.

3 Push the multi-function dial to finish the adjustment.

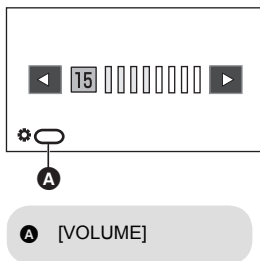

- You can also adjust the volume by touching ◀/▶ in Step 2. Not performing touch operations after the adjustment allows you to exit the setting.



Motion picture/Still picture playback

- 1 Set this unit to playback mode. (→ 22)
- 2 Touch the play mode select icon **A**.
- 3 Select the media **C** you wish to play back.
- 4 (To set this unit to Motion Picture Playback Mode)
Touch the desired recording mode **D** and recording format **E** for playback.

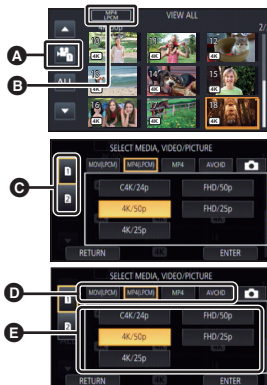

- The available recording format options differ depending on [SYSTEM FREQ] (→ 159) or the recording mode option you have touched.
- Touch [ENTER].
- A recording mode icon **B** will be displayed on the thumbnail display. (MOV LPCM / MP4 LPCM / MP4 / AVCHD)
- (If you have touched the recording mode option [MOV(LPCM)], [MP4(LPCM)] or [MP4])
After you have touched a recording format option, one of the following icons will be displayed on each thumbnail. The icon to be displayed differs depending on the size of recording format.
 - Scenes recorded in C4K (4096×2160): **C4K**
 - Scenes recorded in 4K (3840×2160): **4K**
 - Scenes recorded in FHD (1920×1080): **HD**
- (If you have touched the recording mode option [AVCHD])
After you have touched a recording format option, one of the following icons will be displayed on each thumbnail.
 - Scenes recorded in [PS 1080/50p]/[PS 1080/60p]: **PS**
 - Scenes recorded in [PH 1080/50i]/[PH 1080/60i]: **PH**
 - Scenes recorded in [HA 1080/50i]/[HA 1080/60i]: **HA**
 - Scenes recorded in [HE 1080/50i]/[HE 1080/60i]: **HE**
 - Scenes recorded in [PM 720/50p]/[PM 720/60p]: **PM**

(To set this unit to Still Picture Playback Mode)

Touch the still picture **F**.

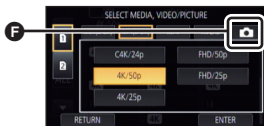

5 Touch the scene or the still picture to be played back.

- Next (Previous) page can be displayed by touching **▲** / **▼**.

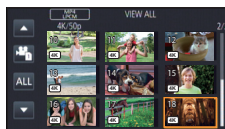

6 Select the playback operation by touching the operation icon.





G Operation icon

- If you touch the screen while an operation icon is being displayed or do not touch the icon for a certain period, it will disappear. To display again, touch the screen.

Motion picture playback	Still picture playback
<p>▶/ : Playback/Pause</p> <p>◀◀: Fast rewind playback*</p> <p>▶▶: Fast forward playback*</p> <p>■: Stops the playback and shows the thumbnails.</p>	<p>▶/ : Slide show (playback of the still pictures in numerical order) start/pause.</p> <p>◀ : Plays back the previous picture.</p> <p> ▶: Plays back the next picture.</p> <p>■: Stops the playback and shows the thumbnails.</p>

* When touched two times, the fast forward/fast rewind speed increases. (Screen display will change to ◀◀ / ▶▶ .)

Change the thumbnail display

While the thumbnail is displayed, the thumbnail display changes in the following order if the zoom lever or the sub zoom lever is operated to  side or  side.

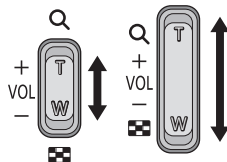

( side)

( side)

20 scenes \longleftrightarrow 9 scenes \longleftrightarrow 1 scene \longleftrightarrow Scene information display*

* Detailed information of the scene is displayed when playing back motion pictures. Following information is displayed.

START TC, START UB, and DURATION are displayed only for AVCHD scenes.

- START TC
- START UB
- DATE
- TIME ZONE
- DURATION
- REC MODE
- FORMAT

- If you press the THUMBNAIL button to switch between Recording Mode and Playback Mode, the thumbnails of 9 scenes will be displayed.
- By displaying in 1 scene, recording date and time are displayed when playing back motion pictures, and recording date and file number when playing back still pictures.

Speaker/Headphone volume adjustment

Operate the volume lever, sub zoom lever or multi-function dial to adjust the speaker/headphone volume during Motion Picture Playback Mode.

Adjusting the volume with the volume lever/sub zoom lever

Towards “+”:

Increases the volume

Towards “-”:

Decreases the volume

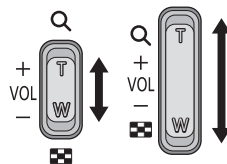
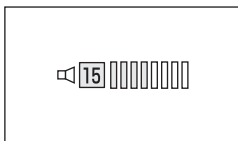

Adjusting the volume with the multi-function dial

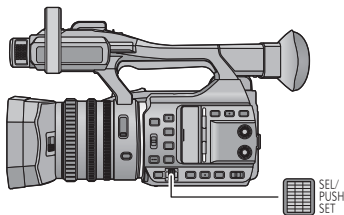

- 1 Push the multi-function dial while [ VOLUME] is displayed.



2 Rotate the multi-function dial to adjust the volume.

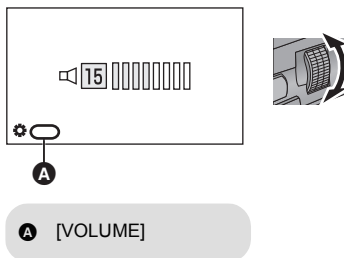

3 Push the multi-function dial to finish the adjustment.

- Sound will be heard only during normal motion picture playback.
- If pause play is continued for 5 minutes, the screen returns to the thumbnails.
- In the following cases, when you select the desired recording format for playback, this unit will be restarted to switch the system frequency:
 - When you have switched recording format from [C4K/24p 100M] to a different option.
 - When you have switched recording format from an option other than [C4K/24p 100M] to [C4K/24p 100M]
- If you set recording mode to [AVCHD] and recording format to [ALL AVCHD], [1080/60i] or [1080/50i] and play back a scene, the screen may turn dark momentarily when it switches to another scene.

Motion picture compatibility









- This unit is based on AVCHD Progressive/AVCHD.
- Even if the devices used have compatible standards, when playback of video recorded using another device is performed using this device, or when video recorded using this device is played back in another device, playback may not proceed normally, or may not be possible. (Please check compatibility in the instruction manual of your device.)

Still picture compatibility

- This unit is compliant with the unified standard DCF (Design rule for Camera File system) established by JEITA (Japan Electronics and Information Technology Industries Association).
- The file format of still pictures supported by this unit is JPEG. (Not all JPEG formatted files will be played back.)
- This unit may degrade or not play back still pictures recorded or created on other products and other products may degrade or not play back still pictures recorded on this unit.
- Depending on the playback device, still pictures may be played back with picture sizes different from the ones with which they were recorded.

Motion picture playback using operation icon

For details on the basic playback operations, refer to page 79.

Playback operation	Playback display	Operating steps
Skip playback (to the start of a scene)	During Playback 	Touch the LCD monitor and slide from right to left (from left to right) during playback.
Slow-motion Playback	During Pause 	<p>With the playback paused, continue touching .</p> <p>( is for slow rewind playback.)</p> <p>Playback is slow while touching.</p> <ul style="list-style-type: none"> Normal playback is restored when you touch . When AVCHD scenes are played back in reverse slow-motion, they will be shown continuously at approximately 2/3rd the speed of normal playback (at 0.5 second intervals). MOV/MP4 scenes are played back as follows: <ul style="list-style-type: none"> Scenes recorded with [REC FORMAT] set to [FHD/50p ^{ALL-I} 200M], [FHD/25p ^{ALL-I} 200M], [FHD/60p ^{ALL-I} 200M], [FHD/30p ^{ALL-I} 200M], [FHD/24p ^{ALL-I} 200M]: Reverse slow-motion playback at 1 second intervals Scenes recorded with [REC FORMAT] set to an option other than the above: Reverse slow-motion playback at 0.5 second intervals
Frame-by-frame Playback	During Pause 	<p>With the playback paused, touch .</p> <p>(Touch  to advance the frames one at a time in the reverse direction.)</p> <ul style="list-style-type: none"> Normal playback is restored when you touch . Frames are played back at 0.5 second intervals during reverse frames-by-frame playback.

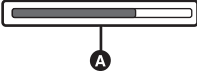
Playback operation	Playback display	Operating steps
<p>Direct playback</p>	<p>During Playback</p>  <p>The diagram shows a horizontal rectangular bar representing a playback progress bar. The bar is divided into two sections: a dark grey section on the left and a white section on the right. Below the center of the bar, a vertical line connects to a circular button containing the letter 'A', representing a play/pause control.</p>	<p>Touch the direct playback bar A or slide it while touching.</p> <ul style="list-style-type: none"> • The playback pauses temporarily and skips to the position touched or slid to while touching. • Playback will start by releasing your touching or sliding finger.



Useful functions

Creating still picture from motion picture

You can save a frame of a recorded motion picture as a still picture. The picture size with which a still picture will be recorded differs depending on the picture size of [REC FORMAT] with which the motion picture was recorded.

Recording format	Aspect ratio	Picture size
[REC FORMAT] setting with a size of C4K (4096×2160)	17:9	4096×2160
[REC FORMAT] setting with a size of 4K (3840×2160)	16:9	3840×2160
[REC FORMAT] setting with a size of FHD (1920×1080)		1920×1080
[PS 1080/50p]/[PS 1080/60p]/ [PH 1080/50i]/[PH 1080/60i]/ [HA 1080/50i]/[HA 1080/60i]/ [HE 1080/50i]/[HE 1080/60i]		
[PM 720/50p]/[PM 720/60p]		1280×720

While playing back a motion picture, touch the at the scene you want to save it as a still picture.

- If you register [CAPTURE] to any of the USER buttons 1–6, you can capture a still picture by pressing the USER button. For information on how to register functions to the USER buttons, refer to page 61.
- It is convenient to use Pause, Slow-motion Playback and Frame-by-frame Playback.
- Date will be registered as date of the still picture.
- Quality will be different from the normal still picture.



Repeat Playback

Playback of the first scene starts after playback of the last scene finishes.

: [VIDEO SETUP] → [REPEAT PLAY] → [ON]

The indication appears on the full screen views.

- All the scenes displayed in the thumbnail will be repeatedly played back.
-
- Repeat Playback cannot be used for the slide show playback of the still pictures. (→ 80)

Resuming the previous playback

If playback of a scene was stopped halfway, the playback can be resumed from where it was stopped.

: [VIDEO SETUP] → [RESUME PLAY] → [ON]

If playback of a motion picture is stopped,  appears on the thumbnail view of the stopped scene.

- The memorised resume position is cancelled if you turn off the unit or press the THUMBNAIL button. (The setting of [RESUME PLAY] does not change.)

Playing back scenes or still pictures by date

The scenes or still pictures recorded on the same day can be played back in succession.

1 Touch the date select icon.



A Date select icon

2 Touch the playback date.

The scenes or still pictures recorded on the date selected are displayed as thumbnails.

3 Touch the scenes or still picture to be played back.

- If you press the THUMBNAIL button to switch between Recording Mode and Playback Mode, the thumbnails of all scenes will be displayed.
- In cases such as those described below, scenes and still pictures are grouped separately on the date list, and -1, -2... may be added after the date:
 - When the number of scenes exceeds 99
 - When the number of still pictures exceeds 999
 - When you change the [REC FORMAT] setting
 - When you set [REC MODE] to [AVCHD] and set Time Lapse Recording to an option other than [OFF]
 - When you set [REC MODE] to [MOV(LPCM)], [MP4(LPCM)] or [MP4] and change the system frequency
 - When [NUMBER RESET] is performed

- Scenes recorded with the following [REC FORMAT] settings are grouped separately on the date list. A recording format icon will be displayed next to the date.

Recording format	Icon to be displayed
[REC FORMAT] setting with a size of C4K (4096×2160)	
[REC FORMAT] setting with a size of 4K (3840×2160)	
[REC FORMAT] setting with a size of FHD (1920×1080)	
[PS 1080/50p]/[PS 1080/60p]	
[PH 1080/50i]/[PH 1080/60i]	
[HA 1080/50i]/[HA 1080/60i]	
[HE 1080/50i]/[HE 1080/60i]	
[PM 720/50p]/[PM 720/60p]	

- is displayed after the date in the list by date for the still pictures created from the motion picture. (→ 85)

Playback

Deleting scenes/still pictures

Deleted scenes/still pictures cannot be restored, so perform appropriate confirmation of the contents before proceeding with deletion.

- Press the THUMBNAIL button to switch this unit to the Playback Mode. (→ 22)
- To delete the scene or still picture being played back**

Touch while scenes or still pictures to be deleted are being played back.



To delete scenes or still pictures from the thumbnail display

- Switch to the thumbnail display of the scenes or still pictures to delete. (→ 79)

1 Select the menu.

: [VIDEO SETUP] or [PHOTO SETUP] → [DELETE] → desired setting

[ALL SCENES]:

All the scenes or still pictures displayed as thumbnails can be deleted. (When playing back scenes or still pictures by date, all scenes or still pictures of the selected date will be deleted.)

[MULTI]:

Multiple scenes or still pictures can be selected and deleted.

[SINGLE]:

Single scene or still picture can be selected and deleted.

- Protected scenes/still pictures cannot be deleted.

2 (When [MULTI] is selected in Step 1)

Touch the scene/still picture to be deleted.

- When touched, the scene/still picture is selected and the  indication appears on the thumbnail. Touch the scene/still picture again to cancel the operation.
- Up to 99 scenes can be selected to be deleted.

(When [SINGLE] is selected in Step 1)

Touch the scene/still picture to be deleted.

3 (When [MULTI] is selected in Step 1)

Touch [Delete].

- To continuously delete other scenes/still pictures, repeat Steps 2-3.

When you stop deleting halfway:

Touch [CANCEL] or press MENU button while deleting.

- The scenes or still pictures that have already been deleted when the deletion is cancelled cannot be restored.

To complete editing:

Touch [Return] or press MENU button.

-
- Scenes/still pictures that cannot be played back (the thumbnails are displayed as ) cannot be deleted.
 - In case of [ALL SCENES], the deletion may take time if there are many scenes or still pictures.
 - If you delete scenes recorded on other products or still pictures conforming to DCF standard with this unit, all the data related to the scenes/still pictures may be deleted.
 - When still pictures recorded on an SD card by other products are deleted, a still picture (other than JPEG) that cannot be played back on this unit, may be erased.

Protecting scenes/still pictures



Scenes/still pictures can be protected so that they are not deleted by mistake.

(Even if you protect some scenes/still pictures, formatting the media will delete them.)

- Press the THUMBNAIL button to switch this unit to the Playback Mode. (→ 22)

1 Select the menu.

 : [VIDEO SETUP] or [PHOTO SETUP] → [SCENE PROTECT]

2 Touch the scene/still picture to be protected.

- When touched, the scene/still picture is selected and the  indication appears on the thumbnail. Touch the scene/still picture again to cancel the operation.
- Touch [Return] to complete the settings.

Watching Video/Pictures on your TV

Confirm the terminals on your TV and use a cable compatible with the terminals. Image quality may vary with the connected terminals.

- A** High quality
- 1** HDMI terminal
- 2** Video terminal

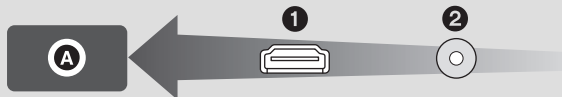

- When [SYSTEM FREQ] is set to a broadcasting system different from that of your region, images may not be played back correctly. (→ 159)
- Use the HDMI cable (supplied).
- HDMI is the interface for digital devices. If you connect this unit to a HDMI compatible high definition TV and then play back the recorded high definition images, you can enjoy them in high resolution with high quality sound.
- By connecting this unit to a 4K-compatible TV and play back scenes recorded with their size set to C4K (4096×2160) or 4K (3840×2160)* in [REC FORMAT], you can enjoy finely-detailed 4K motion pictures. Even though the output resolution will be lower, you can also play them back by connecting this unit to a high-definition TV or other device that does not support 4K motion pictures.
- * To output scenes in the recording format option [4K/50p 150M], you need a TV that supports 4K/50p.
- If you connect this unit and a 4K-compatible TV in Recording Mode, even when [REC FORMAT] is set to a setting with a size of C4K (4096×2160) or 4K (3840×2160), images are output to the TV in 1920×1080.

1 Connect this unit to a TV.

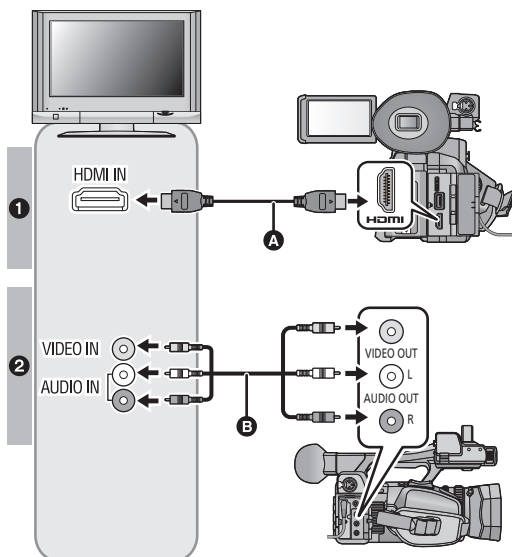

- A** HDMI cable (supplied)
- Be sure to connect to the HDMI terminal.
- Connecting with a HDMI cable (→ 92)
- B** AV cable (commercially-available)

Picture quality

- 1** To play back images recorded in 4K or high definition picture quality, connect this unit to the HDMI terminal of the TV.
- 2** To play back standard images, connect this unit to the video terminal of the TV.

- Check that the plugs are inserted as far as they go.
- Do not use any other HDMI cables except the supplied one.
- When connecting this unit and a TV that supports 4K motion pictures with an HDMI cable, connect it to an HDMI terminal that supports 4K. For details, refer to the operating instructions for the TV.

2 Select the video input on the TV.

- Example:
 - Select the [HDMI] channel with a HDMI cable.
 - Select the [Video 2] channel with an AV cable.
 - (The name of the channel may differ depending on the connected TV.)
- Check the input setting (input switch) and the audio input setting on the TV. (For more information, please read the operating instructions for the TV.)

3 Change the mode to to play back.

- This unit is not compatible with the VIERA Link.
 - If you connect this unit to the TV when this unit is set to Recording Mode, a squealing sound*¹ may be output. Before connecting this unit, set it to Playback Mode.
- *1 The microphone may pick up the sound from the speakers, producing an abnormal sound.
- When connected to the TV, sound in Playback Mode is not output from this unit. Also, since the volume cannot be adjusted with this unit, adjust the volume of the TV.
 - Some screens, such as the menu screen, may be displayed in reduced sizes on the TV.
 - Image and audio is not output from this unit while using the Wi-Fi function.
 - When this unit and the TV are connected with an AV cable (commercially-available), even if you set [HDMI RESOLUTION] to [DOWN CONV.], scenes in the recording format option [C4K/24p 100M] cannot be output.

■ To watch images on a regular TV (4:3) or when both sides of the images do not appear on the screen

Change the menu setting to display the images correctly. (Check the TV setting.)

1 Select the [HDMI RESOLUTION] menu.

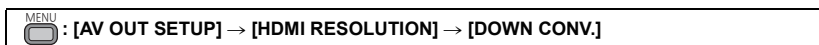

2 Select the [DOWN CONV.] menu.

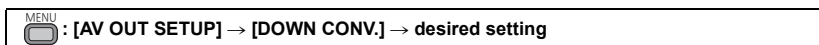

[SIDE CROP]:	Outputs an image by fitting it to the height of the TV screen
[LETTERBOX]:	Outputs an image by fitting it to the width of the TV screen
[SQUEEZE]:	Outputs an image by compressing it in the horizontal direction to fit it in the screen.

- This item is fixed to [SQUEEZE] when the recording format size is set to C4K (4096×2160) or 4K (3840×2160).

Example of images with a [17:9] or [16:9] aspect ratio on a regular TV (4:3):

[HDMI RESOLUTION] setting	
[AUTO]/[2160p]/[1080p]/[1080i]/[720p]	[DOWN CONV.]

*2 The screen is displayed this way when [HDMI RESOLUTION] is set to [DOWN CONV.] and [DOWN CONV.] is set to [LETTERBOX]. (→ 157)

- If a wide-screen TV is connected, adjust the aspect setting on the TV. (Refer to the operating instructions of the TV for details.)
- When [HDMI RESOLUTION] is set to [DOWN CONV.], the aspect ratio of an image displayed on the TV can be changed through the [DOWN CONV.] setting.
- When [DOWN CONV.] is set to [SIDE CROP], the sides of an image will be cut off, causing some icons on the TV to be hidden from the TV screen.

■ To display the on-screen information on the TV

When the menu setting is changed, the information displayed on the screen (operation icon and Counter display etc.) can be displayed/not displayed on the TV.

MENU



: [DISP SETUP] → [VIDEO OUT OSD] → [ON] or [OFF]

Refer to the following support site for information about Panasonic TVs with an SD card slot for playing back your pictures.

<http://panasonic.net/>

- You can play back AVCHD scenes and scenes recorded with [REC MODE] set to [MP4].
- Some scenes may not be playable depending on the recording format option.
- For more information on the playback operations and other details, refer to the operating instructions for the TV.

Connecting with a HDMI cable

Select the desired method of HDMI output.

MENU



: [AV OUT SETUP] → [HDMI RESOLUTION] → [AUTO]/[2160p]/[1080p]/[1080i]/[720p]/
[DOWN CONV.]

- [AUTO] determines the output resolution automatically based on information from the connected TV.
If the images are not output on the TV when the setting is [AUTO], switch to the method [2160p], [1080p], [1080i], [720p] or [DOWN CONV.] which enables the images to be displayed on your TV. (Please read the operating instructions for the TV.)
- [DOWN CONV.] will output images in 4:3.
- Images may not be displayed on the television for several seconds in some cases, such as when changing between scenes.
- Even if you set [HDMI RESOLUTION] to [1080i], [720p] or [DOWN CONV.], scenes with a recording format size of C4K (4096×2160) are output in 1080p.
- Even if you set [HDMI RESOLUTION] to [2160p], scenes with a recording format picture size of 1920×1080 or below are output in 1080p.

Using this unit with a PC

What you can do with a PC

When you connect this unit to a PC, it recognises this unit as a card reader. The connection enables you to access the SD card in this unit from the PC.

- To perform non-linear editing, copy the data of motion pictures and still pictures to the PC you will be using to edit it. (→ 95)
- You can use HD Writer XE 2.0 for Windows. (→ 97)
- Final Cut Pro supported. For details about Final Cut Pro, please contact Apple Inc.

Connecting to a PC

- When using HD Writer XE 2.0, connect this unit to the PC after the software applications are installed.

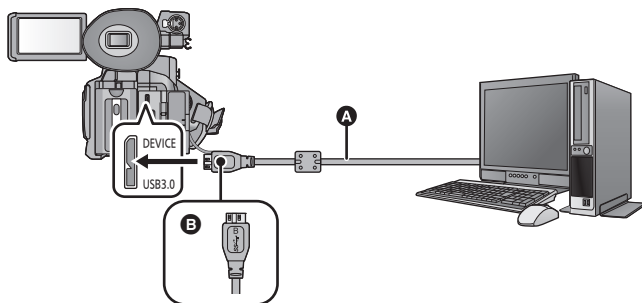

- A** USB cable (supplied)
 - B** Turn the left side with the symbol up to connect the Micro-B end of the USB Cable to the USB terminal of this unit.
- Insert the plugs as far as they will go.

1 Connect this unit to the AC adaptor.

- Use the AC adaptor to free you from worrying about the battery running down.

2 Turn on the unit.

3 Press the THUMBNAIL button to switch this unit to the Playback Mode.

4 Set [USB MODE] to [DEVICE].

MENU : [OTHER FUNCTION] → [USB MODE] → [DEVICE]

5 Connect this unit to a PC.

- The USB function selection screen will appear.

6 Touch [PC] on the screen of this unit.

- This unit is automatically recognised as an external drive of the PC. (→ 96)
- When you select an option other than [PC], reconnect the USB cable.
- When using the battery, the LCD monitor turns off after about 5 seconds. Touch the screen to turn the LCD monitor on.

-
- Do not use any other USB cables except the supplied one. (Operation is not guaranteed with any other USB cables.)
 - When performing reading/writing between a PC and an SD card, be aware that some SD card slots built into PCs and some SD card readers are not compatible with the SDHC Memory Card or SDXC Memory Card.
 - When using an SDXC Memory Card, check the following support site.
<http://panasonic.net/avc/sdcard/information/SDXC.html>

About the screen indication of the unit

- Do not disconnect the USB cable, battery, or AC adaptor while the access lamp is on or card access icon () appears on the unit screen.
- If the screen does not change when the unit is operated while connected to a PC, disconnect the battery and/or AC adaptor, wait approximately 1 minute, reconnect the battery and/or AC adaptor, wait approximately 1 minute again, and then turn the unit back on. (Data may be destroyed when above operation is performed while accessing the SD card.)

Using this unit as a card reader

When this device and a computer for editing are connected using a USB Connection Cable, image data in the SD card can be copied.

- Concerning non-linear editing, refer to the instruction manual of your editing software.

Operating environment (mass storage)

To use this unit as a card reader, you need a PC that meets the following system requirements.

- Even if the system requirements mentioned in these operating instructions are fulfilled, some PCs cannot be used.
- The USB equipment operates with the driver installed as standard in the OS.

■ If using Windows

- Operation is not guaranteed in the following cases.
 - Operation on an upgraded OS.
 - Operation on an OS other than the one pre-installed.

OS	Windows 8/Windows 8.1 (32 bit/64 bit) Windows 7 (32 bit/64 bit) SP1
CPU	1 GHz or higher 32-bit (×86) or 64-bit (×64) processor (including compatible CPU)
RAM	2 GB or more (64 bit)/1 GB or more (32 bit)
Interface	USB port
Other requirements	Mouse or equivalent pointing device

■ If using Mac

PC	Mac
OS	OS X v10.9.4
CPU	Intel Core 2 Duo or better
RAM	2 GB or more
Interface	USB port
Other requirements	Mouse or equivalent pointing device

Copy to PC

■ If using Windows

When the unit is connected to a PC, it is recognised as an external drive.

- Removable disk (Example:  CAM_SD (F:)) is displayed in [Computer].

We recommend using HD Writer XE 2.0 to copy motion picture data.

Using Windows Explorer or other programmes on the PC to copy, move or rename files and folders recorded with this unit will result in them being unusable with HD Writer XE 2.0.

It is impossible to write data to SD card on this unit from a PC.

- 1 Double-click the folder that contains the still pictures. ([DCIM] → [100CDPFQ] etc.)**
- 2 Drag and drop the still pictures onto the destination folder (on the PC's HDD).**

To disconnect USB cable safely

Select the  icon in task tray displayed on the PC, and then click [Eject HC-X1000].

- Depending on your PC's settings, this icon may not be displayed.

■ If using Mac

When using this unit as a card reader, [CAM_SD] is displayed on the desktop.

- 1 Double-click [CAM_SD] displayed on the desktop.**
 - Files are stored in [100CDPFQ] folder etc. in the [DCIM] folder.
- 2 Using a drag-and-drop operation, move the pictures you want to acquire or the folder storing those pictures to any different folder on the Mac.**

To disconnect USB cable safely

Drag [CAM_SD] disk icon to the [Trash], and then disconnect the USB cable.

-
- Do not delete the SD card's folders. Doing so may make the SD card unusable in this unit.
 - When data not supported by this unit has been recorded on a PC, it will not be recognised by this unit.
 - Always use this unit to format SD cards.
 - It is possible to play back still pictures on a PC using a image viewer standard to Windows or commercially available image browsing software, and copy still pictures to a PC using Windows Explorer.

About the PC display

Example folder structure of an SD card:

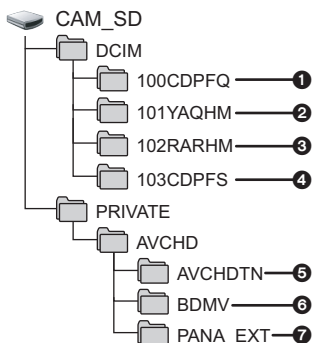

The following data will be recorded.

- ① Up to 999 still pictures in JPEG format ([11000001.JPG] etc.)
- ② MOV format motion picture data ([11000001.MOV], etc.)
- ③ MP4 format motion picture data ([11000001.MP4], etc.)
- ④ JPEG format still pictures created from the motion picture
- ⑤ The motion picture thumbnails
- ⑥ AVCHD format motion picture files ([00000.MTS] etc.)
- ⑦ For management

Folder names for motion picture data recorded in MOV/MP4 format

The fourth to sixth characters of the folder name of a recorded MOV/MP4 scene are determined by its picture size, frame rate, and motion picture format.

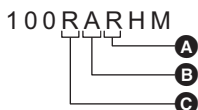

- Ⓐ Motion picture format
- Ⓑ Frame rate
- Ⓒ Picture size

(Example) If the folder name is 100RARHM:

Motion picture data that has a picture size of 3840×2160, frame rate of 59.94 fps, and motion picture format categorised as progressive recording (MP4 and LPCM) is stored.

Picture size	Frame rate	Motion picture format
Y: 1920×1080	A: 59.94 fps	P: Progressive recording (MP4, AAC)
R: 3840×2160	B: 50 fps	Q: Progressive recording (MOV, LPCM)
Q: 4096×2160	C: 29.97 fps	R: Progressive recording (MP4, LPCM)
	D: 25 fps	
	E: 24 fps	
	F: 23.976 fps	

Using HD Writer XE 2.0

Features of HD Writer XE 2.0

You can copy the motion/still picture data to the HDD of PCs or SD cards.
Refer to the operating instructions of HD Writer XE 2.0 (PDF file) for details on how to use it.

What can be done with the HD Writer XE 2.0	Data type
Copying data to a PC	Motion picture and still picture
Editing: Editing motion picture data copied on an HDD of a PC <ul style="list-style-type: none">● Dividing, Trimming, Still picture, Title, Effect, Transition, BGM, Delete partially● Converting part of motion picture into still picture	Motion picture
Online sharing: You can upload motion pictures on the Internet and share them with your family and friends.	
Playing back on a PC: Play back the motion picture data in high-definition picture quality on a PC.	Motion picture and still picture

Important Notice

- When using an SDXC Memory Card, check the following support site.
<http://panasonic.net/avc/sdcard/information/SDXC.html>

- It is impossible to write data to this unit from a PC.
- Motion pictures that have been recorded on another device cannot be written to the software supplied with this unit.
- When motion picture data is written to and read from the SD card, correct operation of the unit cannot be guaranteed if software other than HD Writer XE 2.0 is used.
- Do not start HD Writer XE 2.0 and other software at the same time.
- The time code information of motion pictures edited with HD Writer XE 2.0 will be deleted.

Before Installing HD Writer XE 2.0

Your installation or use of the Software defined below shall be conclusively deemed to constitute your acceptance of the terms of this Agreement. If you do not accept the terms of this Agreement, do not install, nor use the Software.

End User License Agreement

You ("Licensee") are granted a license for the Software defined in this End User License Agreement ("Agreement") on condition that you agree to the terms and conditions of this Agreement.

The following terms contain material representations regarding the disclaimers of Panasonic Corporation. Be sure to read through, understand and confirm the following terms.

Article 1 License

Licensee is granted the right to use the Software (the "Software" means the software and other information such as manuals downloaded by Licensee through Panasonic website), but all applicable rights to patents, copyrights, trademarks and trade secrets in the Software are not transferred to Licensee.

Article 2 Use by a Third Party

Licensee may not use, copy, modify, transfer, rent, lease, lend or allow any third party, whether free of charge or not, to use, copy or modify the Software, except as expressly provided for in this Agreement.

Article 3 Restrictions on Copying the Software

Licensee may make a single copy of the Software in whole or a part solely for back-up purpose.

Article 4 Computer

Licensee may use the Software only on one computer, and may not use it on more than one computer. Further, Licensee may not use the Software for commercial software hosting services.

Article 5 Reverse Engineering, Decompiling or Disassembly

Licensee may not reverse engineer, decompile, or disassemble the Software, except to the extent either of them is permitted under law or regulation of the country where Licensee resides. Panasonic, or its distributors will not be responsible for any defects in the Software or damage to Licensee caused by Licensee's reverse engineering, decompiling, or disassembly of the Software.

Article 6 Indemnification

The Software is provided "AS-IS" without warranty of any kind, either expressed or implied, including, but not limited to, warranties of non-infringement, merchantability and/or fitness for a particular purpose. Further, Panasonic does not warrant that the operation of the Software will be uninterrupted or error free. Panasonic or any of its distributors will not be liable for any damage suffered by Licensee arising from or in connection with Licensee's use of the Software.

Article 7 Export Control

Licensee agrees not to export or re-export to any country the Software in any form without the appropriate export licenses under regulations of the country where Licensee resides, if necessary.

Article 8 Termination of License

The right granted to Licensee hereunder will be automatically terminated if Licensee contravenes any of the terms and conditions of this Agreement. In this event, Licensee must destroy the Software and related documentation together with all the copies thereof at Licensee's own expense.

Article 9 With regard to MICROSOFT SQL SERVER COMPACT 3.5 produced by Microsoft Corporation

(1) Licensee shall use the MICROSOFT SQL SERVER COMPACT 3.5 only when included in the Software, and shall not use the MICROSOFT SQL SERVER COMPACT 3.5 in any other configuration or method. Licensee shall not publish the MICROSOFT SQL SERVER COMPACT 3.5 or work around any technical limitations in the MICROSOFT SQL SERVER COMPACT 3.5.

(2) Licensee shall not use, copy, distribute, regrant for use or otherwise handle the

Software in any way beyond the range of use granted under Article 9 (1), and shall not conduct operations such as reverse engineering, decompilation, disassembling, etc. of the MICROSOFT SQL SERVER COMPACT 3.5.

(3) All rights, including copyright, patent rights etc. relating to the MICROSOFT SQL SERVER COMPACT 3.5 shall belong to Microsoft Corporation. Licensee shall not claim any rights related to the MICROSOFT SQL SERVER COMPACT 3.5 whatsoever.

Operating environment for HD Writer XE 2.0

- Even if the system requirements mentioned in these operating instructions are fulfilled, some PCs cannot be used.
- Editing 4K motion video may be slow and smooth playback may not be possible, even if the recommended system requirements are fulfilled.
- Operation is not guaranteed in the following cases.
 - When 2 or more USB devices are connected to a PC, or when devices are connected through USB hubs or by using extension cables.
 - Operation on an upgraded OS.
- This software is not compatible with Microsoft Windows 3.1, Windows 95, Windows 98, Windows 98SE, Windows Me, Windows NT, Windows 2000, Windows XP and Windows Vista.

OS	Windows 8/Windows 8.1 (64 bit) Windows 7 (64 bit) SP1
CPU	Intel Pentium 4 2.8 GHz or higher (including compatible CPU) <ul style="list-style-type: none"> ● Intel Core 2 Duo 2.16 GHz or higher or AMD Athlon 64 X2 Dual-Core 5200+ or higher is recommended when using playback function. ● Intel Core 2 Quad 2.6 GHz or higher is recommended when using editing function. ● Intel Core i7 2.8 GHz or higher is recommended when using playback or editing function for AVCHD Progressive (1080/50p, 1080/60p). ● Intel Core i7 3.5 GHz or higher is recommended when using playback or editing function for 4K motion pictures.
RAM	2 GB or more <ul style="list-style-type: none"> ● For 4K motion pictures playback or editing, a minimum of 8 GB of RAM or more is recommended.

Display	High Colour (16 bit) or more (32 bit or more recommended) Desktop resolution of 1024×768 pixels or more (1920×1080 pixels or more recommended) Graphics card complying with DirectX 9.0c (DirectX 10 recommended) and DirectDraw overlay PCI Express™ ×16 is recommended Video memory of 256 MB or more recommended <ul style="list-style-type: none"> When using playback function for 4K motion pictures, a video card that supports hardware decoding of 4K motion pictures is required. (For example) Intel HD Graphics 4000 or higher NVIDIA GeForce 600 series or higher In order to play back or edit 4K motion pictures, at least 2 GB of video memory is required. In order to play back motion pictures with a resolution of 4K, a monitor and a video card that support 4K are required.
Free hard disk drive space	Ultra DMA — 100 or more 450 MB or more (for installing the software)
Sound	DirectSound Support
Interface	USB port
Other requirements	Mouse or equivalent pointing device Internet connection

- This software is only for Windows.
- Input is not supported in languages other than English, German, French, Simplified Chinese and Russian.
- Operation is not guaranteed on Microsoft Windows 7 Enterprise, Windows 8 Enterprise, Windows 8.1 Enterprise and Windows RT.
- For Windows 8/Windows 8.1, this software is available only as a desktop application.
- This software is not compatible with a multi-boot environment.
- This software is not compatible with a multi-monitor environment.
- Available only to administrator account or standard account users in Windows 7, Windows 8 and Windows 8.1. (Installation and uninstallation of the software requires an administrator account.)

■ To use the HD Writer XE 2.0

You will need a high performance PC depending on the functions to be used. It may not properly play back or properly operate depending on the environment of the PC used. Refer to the operating environment and notes.

-
- Operation during the playback may become slow if the CPU or memory is not fulfilling the requirements of the operating environment.
 - Always use the most current driver for the video card.
 - Always make sure there is enough capacity on the HDD in the PC. It may become inoperable or the operation may stop suddenly if the capacity gets low.

Installation

When installing the software, log on to your computer as the Administrator or with a user name with equivalent authorisation. (If you do not have authorisation to do this, consult your manager.)

- Before starting the installation, close all applications that are running.
- Do not perform any other operations on your PC while the software is being installed.
- Explanation of operations is based on Windows 7.

■ Installing HD Writer XE 2.0

Check the website below to download/install the software.

- The software is available for download until the end of December 2018.
http://panasonic.jp/support/global/cs/soft/download/f_xe20.html

■ Uninstalling HD Writer XE 2.0

Follow the steps below to uninstall any software applications that you no longer require.

1 Select [Start] → [Control Panel] → [Uninstall a Program].

2 Select [HD Writer XE 2.0], then click [Uninstall].

- Proceed with the uninstallation by following the on-screen instructions.
- After uninstalling the software, be sure to reboot the PC.

Starting HD Writer XE 2.0

- To use the software, log on as an Administrator or as user name for standard user account.
The software cannot be used with the user name for a guest account.

(On the PC)

Select [Start] → [All Programs] → [Panasonic] → [HD Writer XE 2.0] → [HD Writer XE 2.0].

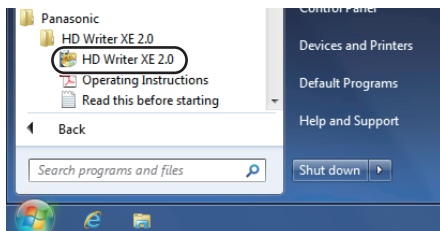

- For details on how to use the software applications, read the PDF operating instructions of the software.

Reading the operating instructions of the software applications

- You will need Adobe Acrobat Reader 5.0 or later or Adobe Reader 7.0 or later to read the PDF operating instructions.

Select [Start] → [All Programs] → [Panasonic] → [HD Writer XE 2.0] → [Operating Instructions].

Copying/playing back with a USB HDD



● In these Operating Instructions, “USB hard disk drive” is indicated as “USB HDD”.
If you connect a USB HDD (commercially-available) to this unit by using a USB Connection Cable (supplied with USB hard disk), you can copy motion pictures and still pictures recorded on this unit to a USB HDD.

It can also play back the scenes and still pictures copied to the USB HDD.

- This unit supports USB 3.0.
- You can copy scenes and still pictures recorded with this unit while maintaining the image quality.
- Please read the operating instructions of the USB HDD for how to use it.

Preparing for copying/playing back

Refer to the following support site for information about USB HDD.

http://panasonic.jp/support/global/cs/e_cam

(This Site is English only)

When the USB HDD that requires formatting is connected, a message is displayed. Follow the instructions on the screen to format it.

Once the USB HDD has been formatted, all data stored on it will be deleted. The data cannot be recovered.

This unit formats the USB HDD in exFAT.

- In the following cases, a USB HDD cannot be used by connecting it to this unit:
 - A USB HDD with a capacity below 32 GB or above 2 TB
 - When a USB HDD has two or more partitions
 - If a USB HDD is in a format other than FAT32 or exFAT
 - When connected by using a USB hub
- You cannot copy scenes recorded on an SDXC Memory Card to a USB HDD in FAT32 format.

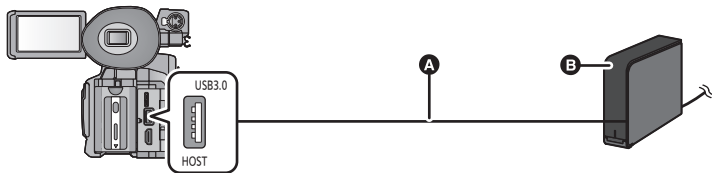

- **A** USB Connection Cable (supplied with USB hard disk)
- **B** USB HDD (commercially-available)
- Connect this unit to the AC adaptor

1 Connect the AC adaptor (supplied with USB HDD) to the USB HDD.

- If you are using a bus-powered or portable USB HDD, this unit can supply power to the USB HDD by USB Connection Cable (supplied with USB HDD).

2 Connect the AC adaptor to this unit.

- Use the AC adaptor to free you from worrying about the battery running down.

3 Turn on this unit, and press the THUMBNAIL button to switch to Playback Mode.

4 Set [USB MODE] to [HOST]. (→ 161)

MENU



[OTHER FUNCTION] → [USB MODE] → [HOST]

5 Connect this unit to the USB HDD with the USB Connection Cable (supplied with USB hard disk).

- It may take several minutes until the connection is completed.

6 Touch the desired item.

[Simple copy]:	Copies all scenes and still pictures recorded with this unit that have not been copied yet. (→ 105)
[Copy selected files]:	Allows you to select desired scenes/still pictures, and then copy. (→ 105)
[Playback from External Drive]:	Plays back scenes and still pictures stored in a USB HDD on this unit. (→ 106)
[Safe Removal]:	Allows you to safely remove this unit and a USB HDD.

- You can perform the following operations by connecting the USB HDD containing scenes and still pictures copied from this unit to another device.
 - Saving the scenes and still pictures on a PC or copying them back from the PC to the USB HDD. Use HD Writer XE 2.0 to perform these operations.

When the USB HDD is connected to other devices such as Blu-ray disc recorder, a message prompting to format the USB HDD may display. All the scenes and still pictures recorded on the USB HDD will be erased if formatted. Do not format as important data will get erased and it will be impossible to restore.

■ Points to check before copying

- When using a USB HDD for the first time, or using a USB HDD that has been used with other devices, first run [FORMAT MEDIA].
- Before copying, go to [MEDIA STATUS] to check the amount of free space on the USB HDD.
- In the following cases, copying may take longer:
 - There are lots of scenes
- If you copy protected scenes or still pictures, the protection setting of the copied scenes or still pictures are cancelled.
- The order in which the scenes were copied cannot be changed.

Before you delete the data on the SD card after copying is complete, be sure to play back the USB HDD to check that they have been copied to correctly. (→ 106)

■ Formatting

This is for initialising the USB HDD.

- Please be aware that if a media is formatted then all the data recorded on the media is erased and cannot be recovered. Back up important data on a PC etc.
- Connect this unit to the USB HDD and touch [Playback from External Drive].

 : [OTHER FUNCTION] → [FORMAT MEDIA] → [EXTERNAL]

- When formatting is complete, touch [EXIT] to exit the message screen.
- Connect this unit and the USB HDD to format.
You may no longer be able to use the USB HDD if you format them on another device such as a PC etc.
- This unit formats the USB HDD in exFAT.

■ Displaying media information

The used space of the USB HDD can be checked.

- Connect this unit to the USB HDD and touch [Playback from External Drive].

 : [OTHER FUNCTION] → [MEDIA STATUS]

- If you touch [CHANGE MEDIA], you can switch the display between the SD card 1, SD card 2, and USB HDD.

Simple copy

1 Connect this unit to the USB HDD to prepare for copying. (→ 102)

2 Touch [Simple copy].

- When [Copy selected files] or [Playback from External Drive] is selected, terminate the connection with the USB HDD (→ 106), and then perform the operation of Step 1.
- You can also copy selected files by touching [COPY] in the menu.

3 Touch the media you want to copy.

4 Touch [YES].

5 Touch [EXIT] when the copy complete message is displayed.

- The thumbnail view of the copy destination is indicated.

When you stop copying halfway:

Touch [CANCEL] while copying.

Copy selected files

1 Connect this unit to the USB HDD to prepare for copying. (→ 102)

2 Touch [Copy selected files].

- You can also copy selected files by touching [COPY] in the menu.

3 Touch the media you want to copy.

[1 → ]: When copying from the SD card 1 to the USB HDD.

[2 → ]: When copying from the SD card 2 to the USB HDD.

4 Touch the desired items following the instructions on the screen.

- (When [SELECT SCENES] is selected)
When touched, the scene/still picture is selected and the  indication appears on the thumbnail. Touch the scene/still picture again to cancel the operation.
- (When [SELECT DATE] is selected)
When touched, the date is selected and surrounded by red. Touch the date again to cancel the operation.
- Up to 99 scenes/ 99 dates can be selected continuously.

5 Touch [EXIT] when the copy complete message is displayed.

- The thumbnail view of the copy destination is indicated.

When you stop copying halfway:

Touch [CANCEL] while copying.

Playing back the External Drive

- Only motion picture/still picture that have been copied by connecting this unit to the USB HDD or copied with HD Writer XE 2.0 can be played back.

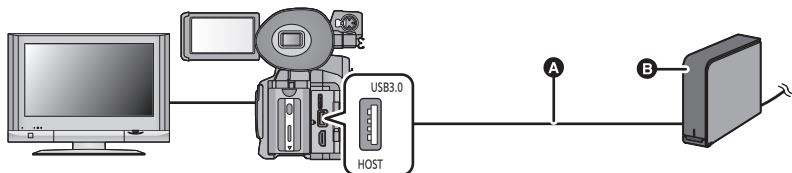

- A** USB Connection Cable (supplied with USB hard disk)
- B** USB HDD (commercially-available)

1 Connect this unit to the USB HDD to prepare for playback. (→ 102)

- When playing back on a TV, connect this unit to the TV. (→ 89)

2 Touch [Playback from External Drive].

3 Touch the scene or still picture to be played back and then play it back.



- The playback operation is performed the same as when playing back motion pictures or still pictures. (→ 79, 83)

To terminate the connection between this unit and the USB HDD

Touch the play mode select icon (→ 79) and then touch .

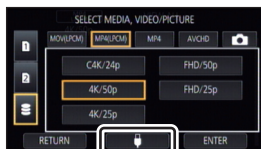
- Disconnect the USB Connection Cable from this unit.





- It is also possible to switch the media to play back by touching the play mode select icon. When the USB HDD is connected, the  (USB HDD) can be selected from the displayed media types. (→ 79)
- In the following cases, when you have touched a play mode select icon and selected the recording format for playback, this unit will be restarted to change the system frequency. After the restart, perform Step 2.
 - When you have switched recording format from [C4K/24p 100M] to a different option.
 - When you have switched recording format from an option other than [C4K/24p 100M] to [C4K/24p 100M]
- Deleting scenes and still pictures on the USB HDD may take time.
- You cannot set the [SCENE PROTECT] during playback of .

Dubbing with a Blu-ray disc recorder, video device, etc.

■ Check before dubbing

Check the equipment used for dubbing.

Equipment used for dubbing	Dubbing picture quality	To dub
Equipment with SD card slot	High-definition picture quality*	Insert the SD card directly (→ 108) 
Equipment with USB terminal	High-definition picture quality*	Connect with supplied USB cable (→ 108) 
Equipment without SD card slot or USB terminal	Standard picture quality This can be played back on equipment incompatible with high-definition (AVCHD), so it is convenient if you are dubbing for distribution.	Connect with AV cable (commercially-available) (→ 110) 

* You can dub AVCHD scenes and scenes in the recording mode option [MP4]. Note that among these scenes, those with a recording format size of 4K (3840×2160) cannot be dubbed. Some equipment may not be compatible with high-definition (AVCHD) picture quality or MP4. In such a case, connect with the AV cable (commercially-available) and dub with standard picture quality. (→ 110)

- For the positions of the SD card slot, USB terminal, or terminal for connecting the AV cable, refer to the operating instructions of the equipment used.

You can dub scenes recorded with [REC MODE] set to [AVCHD] to a Panasonic Blu-ray disc recorder or a Panasonic DVD recorder that supports high-definition (AVCHD).

- **Depending on the recorders or the media to be copied to, you may not be able to copy in high-definition (AVCHD) picture quality. For further details, see the operating instructions of your recorder.**
- You can dub scenes recorded with [REC MODE] set to [MP4] to a Panasonic Blu-ray disc recorder that supports MP4 format.
- Scenes recorded with [REC FORMAT] set to [PS 1080/50p] can be dubbed to a Blu-ray disc only by using a device that supports AVCHD Progressive. When this unit is connected to a device that does not support AVCHD Progressive, scenes recorded with [REC FORMAT] set to [PS 1080/50p] are not displayed.
- **Note that the equipment described may not be available in certain countries and regions.**

- You cannot dub scenes in the recording mode option [MOV(LPCM)] or [MP4(LPCM)].
- When [SYSTEM FREQ] is set to a broadcasting system different from that of your region, dubbing may not be possible.
- When dubbing scenes in the recording mode option [MP4] that have a recording format size of 4K (3840×2160), use HD Writer XE 2.0 to convert their format to FHD (1920×1080). For details, refer to the operating instructions for HD Writer XE 2.0. (→ 97)

Dubbing in high-definition picture quality



■ To dub using equipment with an SD card slot

You can dub by directly inserting an SD card.

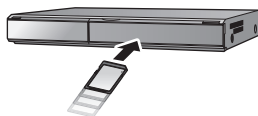

■ To dub using equipment with a USB terminal

You can dub by connecting a USB cable.

- Use the AC adaptor to free you from worrying about the battery running down.
- Turn on the unit.
- Press the THUMBNAIL button to switch this unit to the Playback Mode. (→ 22)

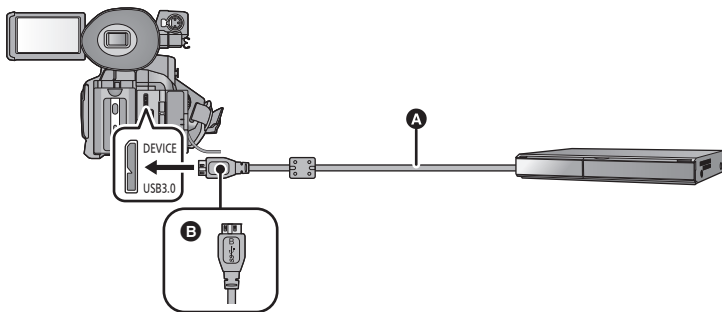

- A** USB cable (supplied)
 - B** Turn the left side with the symbol up to connect the Micro-B end of the USB Cable to the USB terminal of this unit.
- Insert the plugs as far as they will go.

1 Set [USB MODE] to [DEVICE]. (→ 161)

MENU : [OTHER FUNCTION] → [USB MODE] → [DEVICE]

2 Connect the unit to the Blu-ray disc recorder or high-definition (AVCHD) compatible DVD recorder.

- The USB function selection screen will appear on the screen of the unit.

3 Touch [RECORDER] on the screen of this unit.

- When you select an option other than [RECORDER], reconnect the USB cable.

4 Touch the media you wish to dub.

- When using the battery, the LCD monitor turns off after about 5 seconds. Touch the screen to turn the LCD monitor on.

About the screen indication of the unit

When the unit is accessing the SD card, card access icon () appears on the unit screen or the access lamp is on.

- Be careful not to disconnect the USB cable, AC adaptor or battery while the unit is accessing the media, as this may result in the loss of recorded content.

5 Dubbing through operations on the Blu-ray disc recorder or high-definition (AVCHD) compatible DVD recorder.

- Do not touch [CHANGE MEDIA] on the screen of the unit during dubbing.
-
- Do not use any other USB cables except the supplied one. (Operation is not guaranteed with any other USB cables.)
 - For details on dubbing and playback methods, read the operating instructions of the Blu-ray disc recorder or DVD recorder.
 - When you connect the unit to a Blu-ray disc recorder, a dubbing operations screen may appear on the television connected to the Blu-ray disc recorder. In this case as well, perform the operations of Steps 2 to 5.
 - You cannot switch the Recording Mode/Playback Mode by pressing the THUMBNAIL button on this unit while the Blu-ray disc recorder or DVD recorder is connected. Disconnect the USB cable before performing either of these operations.
 - If the battery runs down during dubbing, a message will appear. Operate the Blu-ray disc recorder to cancel the dubbing.

Dubbing in standard picture quality

■ Dubbing using equipment without an SD card slot or a USB terminal, or using a video device

You can dub by connecting an AV cable (commercially-available).

- **Images are dubbed in standard quality.**
- Use the AC adaptor to free you from worrying about the battery running down.

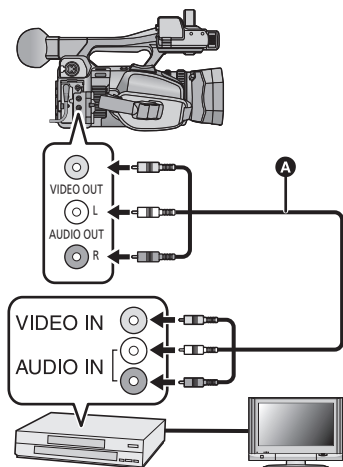

Change the video input on the video device and TV that this unit is connected to.

- The channel set will differ depending on the terminal to which the unit is connected.
- See the operating instructions of the video device for details.
- Insert the plugs as far as they will go.
- **A** AV cable (commercially-available)

- Press the **THUMBNAIL** button to switch this unit to the Playback Mode. (→ 22)

1 Connect this unit to a video device and start playback on this unit.

2 Start recording on the connected device.

- To stop recording (dubbing), stop playback on this unit after stopping recording on the recorder.

-
- When this unit and the TV are connected with an AV cable (commercially-available), even if you set [HDMI RESOLUTION] (→ 92) to [DOWN CONV.], scenes in the recording format option [C4K/24p 100M] cannot be output.
 - Some screens, such as the menu screen, may be displayed in reduced sizes on the TV.
 - If the date and time display and function indication are not wanted, cancel them before dubbing. (→ 92, 154)

If the dubbed images are played back on a wide-screen TV, the images may be stretched vertically.

In this case, refer to the operating instruction for the device you are connecting to or read the operating instructions of the wide-screen TV and set the aspect ratio to 16:9.

Wi-Fi[®] function

■ Use this unit as a wireless LAN device

When using equipment or computer systems that require more reliable security than wireless LAN devices, ensure that the appropriate measures are taken for safety designs and defects for the systems used. Panasonic will not take any responsibility for any damage that arises when using this unit for any purpose other than as a wireless LAN device.

■ Use of the Wi-Fi function of this unit is presumed to be in countries where this unit is sold

There is the risk that this unit violates the radiowave regulations if used in countries other than those where this unit is sold, and Panasonic takes no responsibility for any violations.

■ There is the risk that data sent and received via radio waves may be intercepted

Please note that there is the risk that data sent and received via radio waves may be intercepted by a third party.

■ Do not use this unit in areas with magnetic fields, static electricity or interference

- Do not use this unit in areas with magnetic fields, static electricity or interference, such as near microwave ovens. Radio waves may not reach this unit.
- Using this unit near devices such as cordless telephones or any other wireless LAN device that use the 2.4 GHz radio wave band may cause a decrease in performance in both devices.

■ Do not connect to the wireless network you are not authorised to use

When this unit utilises its Wi-Fi function, wireless networks will be searched automatically. When this happens, wireless networks that you are not authorised to use (SSID*) may be displayed, however do not attempt to connect to the network as it may be considered as unauthorised access.

* SSID refers to the name of device that is used to identify a network over a wireless LAN connection. If the SSID matches for both devices, transmission is possible.

■ Before use

To use a Wi-Fi function with this unit, you need a wireless access point or destination device equipped with a wireless LAN function.

- **For the operations and settings of your device such as the smartphone, please read the operating instructions of the device.**

■ This unit is NFC-compatible

Using the NFC (Near Field Communication) function, you can easily transfer data necessary for a Wi-Fi connection between this unit and the smartphone.

This function can be used with the NFC compatible device with Android™ (OS version 2.3.3 or later). (Except for some models)

■ This unit is WPS-compatible

WPS (Wi-Fi Protected Setup™) is a function that allows you to easily set up a connection with a wireless LAN device and make security-related settings.

- This unit cannot be used to connect to a public wireless LAN connection.
- Use a IEEE802.11b, IEEE802.11g or IEEE802.11n compatible device when using a wireless access point.
- This unit uses the 2.4 GHz frequency band. You cannot establish a wireless LAN connection using the 5 GHz frequency band.
- When using a wireless access point, we strongly recommend that you set a encryption to maintain information security.
- This unit may not connect to a wireless access point depending on the radio wave condition.
- When using the Wi-Fi function, do not cover the Wi-Fi transmitter with your hand. (→ 6)
- When the battery indicator is flashing red, the connection with other equipment may not start or the connection may be disrupted.
- The Wi-Fi transmitter may become warm when using the Wi-Fi function; however this is not a sign of a malfunction. (→ 6)

Remote operation

Using a smartphone, you can perform record operations from a remote location.

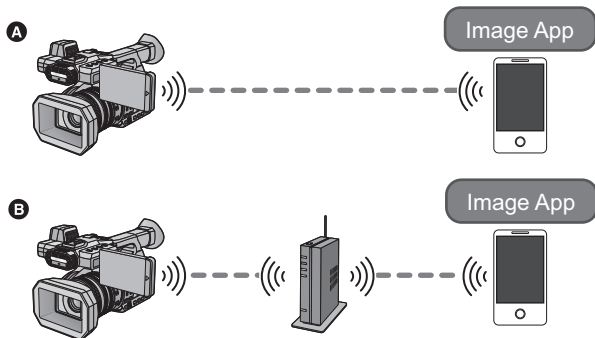

- A** When connecting directly to a smartphone
- B** When connecting to a wireless access point

• You need to turn on the Wi-Fi function of your smartphone.

- Refer to [Help] in the "Image App" menu about function of Image App.

Caution:

Be sure to pay special attention to the privacy, the likeness rights, etc. of the subject when you use this function. Use at your own risk.

Remote operation range

The distances in which you can operate this unit remotely from a smartphone with a direct Wi-Fi connection are as follows:

- Indoors: within approximately 10 m
- Outdoors: within approximately 6 m
- Depending on your smartphone and the radio wave conditions, you may not be able to operate this unit remotely.

Preparations before using remote operation

- 1** Install the smartphone application "Image App" on your smartphone. (→ 119)
- 2** Check if the smartphone is an Android (NFC-compatible), Android (non-NFC-compatible), or iOS device.
 - If your smartphone is NFC-compatible, a message asking you to touch the NFC mark on the device will be displayed when starting up the "Image App".
- 3** Register [Wi-Fi] to a USER button. (→ 61)
 - Please refer to page 61 for details about setting the USER button.

Setting up a direct Wi-Fi connection between this unit and a smartphone

Using NFC, you can easily set up a direct connection between this unit and the smartphone.

■ If the device is Android (NFC-compatible)

Use NFC to set up a direct connection between this unit and the smartphone.

- Proceed to “Using remote operation with a direct connection”. (→ 115)

■ If the device is Android (non-NFC-compatible) or iOS

Operate this unit and the smartphone to set up a direct connection.

- Connecting with WPS (→ 125)
- Connecting with QR code (→ 126)
- Connecting by entering an SSID and Password (→ 126)

When the Wi-Fi connection is complete, proceed to “Using remote operation with a direct connection”. (→ 115)

Setting up a Wi-Fi connection via a wireless access point

1 Check if the wireless access point is compatible with IEEE802.11b/g/n.

2 Set up a Wi-Fi connection between this unit and the wireless access point.

- Connecting with WPS (→ 122)
- Searching for wireless access points to set up a connection (→ 123)
- Setting up a connection manually (→ 124)

When the Wi-Fi connection is complete, proceed to “Using remote operation with a wireless access point connection”. (→ 116)

-
- Using [Wi-Fi Easy Setup], you can also set up a Wi-Fi connection in conjunction with the smartphone application “Image App”. (→ 120)

Using remote operation with a direct connection

If the device is Android (NFC-compatible)

- Set the NFC function of the smartphone to ON.

1 Start up the smartphone application “Image App”.

2 Touch the smartphone on  of this unit.

- Touch the NFC mark while a message asking you to touch the NFC mark on the device is displayed on the smartphone screen.
- If this is the first time the smartphone is connecting to this unit, touch [YES] on the screen of this unit, and then touch the smartphone on  of this unit again.
- If the unit is not recognised even when touching the smartphone, change positions and try again.
- The connection cannot be established while this unit is recording or in Playback Mode.
- When the connection is complete, the image of this unit will be displayed on the smartphone screen.

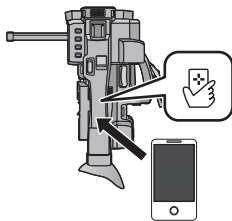

If you touch the second smartphone when this unit has already been connected to the first one

The remote operation with the first smartphone that has been connected to this unit will be cut off, and the newly touched smartphone will be connected.

- The connection cannot be established while this unit is recording or in Playback Mode.

If the device is Android (non-NFC-compatible) or iOS

Proceed to Step 2 when your Wi-Fi connection has been made via [Direct Connection] in [Wi-Fi Setup] (→ 125).

1 Press the USER button to which [Wi-Fi] is registered, and turn on the Wi-Fi function.

-  is displayed

2 Select the following menu items to set up a Wi-Fi connection between this unit and a smartphone.

 : [Wi-Fi Setup] → [Direct Connection]

- When the connection is complete,  will be displayed on the screen of this unit.

3 Start up the smartphone application “Image App”.

- The image of this unit will be displayed on the smartphone screen.

To exit remote operation:

Touch [EXIT] on the screen of this unit or press the USER button to which [Wi-Fi] is registered.

- The message is displayed. Touch [YES] to close the indication.

- If you touch an NFC-compatible smartphone to this unit, you can register up to five smartphones. When the number exceeds five, registrations will be deleted, starting from the oldest touched one.
- Please refer the instructions for the device you are using for information on how to set up and use a NFC-compatible smartphone.

Using remote operation with a wireless access point connection

If the device is Android (NFC-compatible)

- Set the NFC function of the smartphone to ON.

1 Connect the smartphone to a wireless access point.

- When you connect using NFC for the first time, please make connection of this unit and a wireless access point. (→ 122)

2 Start up the smartphone application “Image App”.

3 Touch the smartphone on of this unit.

- Touch the NFC mark while a message asking you to touch the NFC mark on the device is displayed on the smartphone screen.
- If this is the first time the smartphone is connecting to this unit, touch [YES] on the screen of this unit, and then touch the smartphone on  of this unit again.
- If the unit is not recognised even when touching the smartphone, change positions and try again.
- The connection cannot be established while this unit is recording or in Playback Mode.
- When the connection is complete, images stored on this unit are displayed on the smartphone screen.

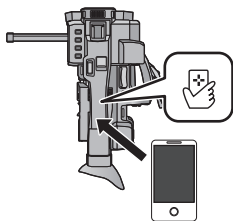

If you touch the second smartphone when this unit has already been connected to the first one

The remote operation with the first smartphone that has been connected to this unit will be cut off, and the newly touched smartphone will be connected.

- The connection cannot be established while this unit is recording or in Playback Mode.

If the device is Android (non-NFC-compatible) or iOS

Proceed to Step 6 when your Wi-Fi connection has been made via [Set Wireless Access Point] in [Wi-Fi Setup] (→ 125).

- 1 Connect the smartphone to a wireless access point.
- 2 Press the USER button to which [Wi-Fi] is registered, and turn on the Wi-Fi function.
 -  will be displayed.
- 3 Select the following menu items to set up a Wi-Fi connection between this unit and a wireless access point.

MENU : [Wi-Fi Setup] → [Set Wireless Access Point]

- Touch [OK].
- 4 Touch the wireless access point to connect.
 - 5 Touch [EXIT].
-  will be displayed when the connection between this unit and the wireless access point is complete.
 - To change the wireless access point to connect to, touch [Change AP], and add a wireless access point or perform operations in Steps 4–5. (→ 129)
- 6 Start up the smartphone application “Image App”.
- When the connection between this unit and the smartphone is complete, images stored on this unit are displayed on the smartphone screen.

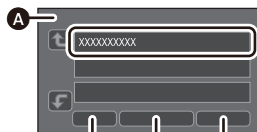

- A [Set Wireless Access Point]
- B [RETURN]
- C [Delete]
- D [EXIT]

To exit remote operation:

Touch [EXIT] on the screen of this unit or press the USER button to which [Wi-Fi] is registered.

- The message is displayed. Touch [YES] to close the indication.

-
- If you touch an NFC-compatible smartphone to this unit, you can register up to five smartphones. When the number exceeds five, registrations will be deleted, starting from the oldest touched one.
 - Please refer the instructions for the device you are using for information on how to set up and use a NFC-compatible smartphone.

About remote operation

Screen display during remote operations

Smartphone screen shots are example displayed in Motion Picture Recording Mode.

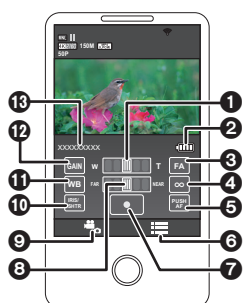
Recording screen	
	<ol style="list-style-type: none">1 Zoom2 Remaining battery power of this unit3 Focus assist*4 Infinity focus5 Push auto focus6 Menu display7 Recording start/stop button8 Focus adjustments9 Recording Mode button10 Iris/Shutter speed adjustments11 White Balance setting12 Gain adjustments13 Name of the connected device

* Focus Assist provides only the expand function during remote operation.

- The displayed content differs depending on Recording Mode (Intelligent Auto Mode/Manual Mode) and other settings.
- Depending on your OS or the version of the smartphone application "Image App", the screens may differ from the ones above.

Functions available for remote operations

■ In Recording Mode



- Recording motion pictures
- Selecting a media to record
- Using the zoom (Available in the medium or fast speed)
- Recording format
- Two slot function
- Focus adjustments
- White Balance setting
- Iris adjustments
- Gain adjustments
- Shutter speed adjustments
- i.Zoom
- Hybrid Optical Image Stabilizer
- Slow shutter
- Digital Zoom
- AGC limit
- Super Gain
- Backlight Compensation
- Recording with infrared light
- Focus assist
- Turning off this unit

- Even if you operate the following switches during remote operation, changes will not be applied to this unit. Operate the switches before remote operation.
 - iA/MANU switch
 - FOCUS A/M/∞ switch
 - ND FILTER switch

Install the “Image App”

About the “Image App”

The “Image App” is an application provided by Panasonic.

	For Android apps	For iOS apps
OS	Android 2.3.3 or later*	iOS 6.0 or later* (iPhone 3GS is not supported.)
Installation procedure	<ol style="list-style-type: none"> 1 Connect your Android device to a network. 2 Select “Google Play™ Store”. 3 Enter “Panasonic Image App” into the search box. 4 Select “Panasonic Image App” and install it. <ul style="list-style-type: none"> • The icon will be added to the menu. 	<ol style="list-style-type: none"> 1 Connect your iOS device to a network. 2 Select “App StoreSM”. 3 Enter “Panasonic Image App” into the search box. 4 Select “Panasonic Image App” and install it. <ul style="list-style-type: none"> • The icon will be added to the menu. 

* The supported OS versions are current as of September 2014 and subject to change.

- Use the latest version.
- Refer to [Help] in the “Image App” menu about function of Image App.
- The service may not be able to be used properly depending on the type of smartphone being used. For information on the “Image App”, check the support website below.
http://panasonic.jp/support/global/cs/e_cam
(This Site is English only.)
- When downloading the app on a mobile network, high packet communication fees may be incurred depending on the details of your contract.

Setting Up a Wi-Fi Connection

To use the Wi-Fi function, connect this unit to a wireless access point or smartphone via Wi-Fi.

■ About the connection status icon when connected to Wi-Fi

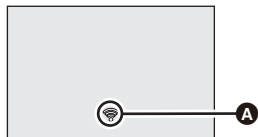

A The connection status icon

When connected to wireless access point:

- connected to Wi-Fi / not connected to Wi-Fi
- The display will change as follows according to the radio wave intensity: (Weak) → → → (Strong).

When directly connected:

- connected to Wi-Fi / not connected to Wi-Fi

Using the Network Easy Setup to set up a connection

With the smartphone application "Image App", you can transfer the following information between the smartphone and this unit by using the NFC or QR code function.

With Network Easy Setup, you can set the following information:

- Clock information (synchronising the clock information with that of the smartphone)
- Information on wireless access points (SSIDs and Passwords)

- Install the smartphone application "Image App" on your smartphone.
- Register [Wi-Fi] to a USER button. (→ 61)

If the device is Android (NFC-compatible)

- Set the NFC function of the smartphone to ON.

- 1 Press the USER button to which [Wi-Fi] is registered, and turn on the Wi-Fi function.
- 2 Select the menu.

MENU : [Wi-Fi Setup] → [Wi-Fi Easy Setup]

- Touch [YES].

- 3 Start up the smartphone application "Image App".

- 4 Touch the smartphone on of this unit.

- Touch the NFC mark while a message asking you to touch the NFC mark on the device is displayed on the smartphone screen.
- If this is the first time the smartphone is connecting to this unit, touch [YES] on the screen of this unit, and then touch the smartphone on of this unit again.
- When the connection is complete, the setup screen is displayed on the smartphone.

5 Follow the on-screen instructions of the smartphone to set up a connection.

- When the settings is complete, the smartphone and this unit are connected directly, allowing you to use remote operations. (→ 115)

Connecting with Android (non-NFC-compatible) or iOS device

1 Press the USER button to which [Wi-Fi] is registered, and turn on the Wi-Fi function.

2 Select the menu.

 : [Wi-Fi Setup] → [Wi-Fi Easy Setup]

- Touch [YES].

3 Touch [QR code] or [Wi-Fi].

■ When [QR code] is selected

1 Start up the smartphone application “Image App”.

2 On the smartphone, select [QR code], and scan the QR code displayed on the screen of this unit.

- The setup screen is displayed on the smartphone.
- When using an iOS device, perform the following operations:
 - ① Select the option that allows you to install the app on the profile screen of the “Image App”, and follow the on-screen instructions to complete the installation.
 - ② Press the home button to close the displayed screen.
 - ③ Touch [NEXT] on the screen of this unit to display its SSID.
 - ④ After selecting the network name (SSID) of this unit from the Wi-Fi setup of the smartphone, start up “Image App”.

3 Follow the on-screen instructions of the smartphone to set up a connection.

- When the settings is complete, the smartphone and this unit are connected directly, allowing you to use remote operations. (→ 115)

■ When [Wi-Fi] is selected

- If you are using an Android device, start up the smartphone application “Image App”.

1 (If the device is Android)

On the smartphone, select [Wi-Fi], and select the SSID displayed on this unit.

(If the device is iOS)

On the smartphone, select the SSID displayed on this unit from the Wi-Fi setup menu.

2 (If the device is Android)

Enter the Password displayed on this unit.

(If the device is iOS)

After entering the Password displayed on this unit, start up the “Image App”.

3 Follow the on-screen instructions of the smartphone to set up a connection.

- When the settings is complete, the smartphone and this unit are connected directly, allowing you to use remote operations. (→ 115)

Connecting to a wireless access point

- Register [Wi-Fi] to a USER button. (→ 61)

Check if the wireless access point you are using is compatible with WPS

- If the wireless access point is compatible with WPS:
Proceed to the following Connecting with WPS
- If the wireless access point is not compatible with WPS:
[Searching for wireless access points to set up a connection] (→ 123)

Connecting with WPS

- 1 Press the USER button to which [Wi-Fi] is registered, and turn on the Wi-Fi function.**
- 2 Select the menu.**

 : [Wi-Fi Setup] → [Set Wireless Access Point]

- Touch [OK].
- 3 Touch the part with no display of a wireless access point.**
- For information on how to delete wireless access points or change the display order of wireless access points, please refer to [Set Wireless Access Point] on page 129.

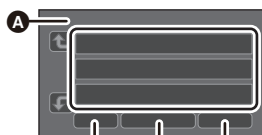

- 4 Touch [Easy Connection (WPS)].**

- A** [Set Wireless Access Point]
- B** [RETURN]
- C** [Delete]
- D** [EXIT]

- 5 Set the wireless access point to waiting for WPS.**

- For further details, please read the operating instructions for the wireless access point.
- A message is displayed when the connection is complete.
- A message is displayed when the connection attempt fails. Touch [EXIT], and set the connection again.



Enter a PIN code to set the Wi-Fi connection

- 1 Touch [PIN code] in Step 5.**
- 2 Touch the wireless access point to be connected.**
 - If you touch [Refresh], you can search for wireless access points again.
- 3 Touch [ENTER].**
- 4 Enter the PIN code displayed on this unit screen into the wireless access point.**
 - For further details, please read the operating instructions for the wireless access point.
- 5 Touch [NEXT].**
 - A message is displayed when the connection is complete.
 - A message is displayed when the connection attempt fails. Touch [EXIT], and set the connection again.

Confirming that the Wi-Fi connection is complete

-  is displayed on the screen

Searching for wireless access points to set up a connection

- Confirm Encryption key (Password) of the selected wireless access point if the network authentication is encrypted.

1 Press the **USER** button to which [Wi-Fi] is registered, and turn on the Wi-Fi function.

2 Select the menu.

 : [Wi-Fi Setup] → [Set Wireless Access Point]

- Touch [OK].

3 Touch the part with no display of a wireless access point.

- For information on how to delete wireless access points or change the display order of wireless access points, please refer to [Set Wireless Access Point] on page 129.

4 Touch [Search].

5 Touch the wireless access point to connect.

- Touch [ENTER].
- If you touch [Refresh], you can search for wireless access points again.
- When no wireless access points are displayed, refer to “Setting up a connection manually”. (→ 124)
- If an Encryption key (Password) is not set, the connection is complete and a message is displayed.

6 (When there is an Encryption key (Password))

Enter the Password.

- For details on how to enter characters, refer to page 124.
- When the entry is complete, touch [Enter].

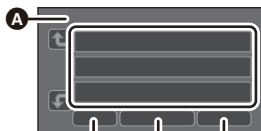

- A** [Set Wireless Access Point]
- B** [RETURN]
- C** [Delete]
- D** [EXIT]

Confirming that the Wi-Fi connection is complete

-  is displayed on the screen

Entering text

- Touch the text entry icon in the centre of the screen and enter the text.

Icon	Description of operation
[A] etc.	Enters a character.
◀ / ▶	Moves the cursor to left or right.
[A/a/1]	Switches between [A]/[a] (alphabet) and [&/1] (symbols/numbers).
␣	Enters a space.
[Delete]	Deletes a character. Deletes the previous character if the cursor is in an empty space.
[Enter]	Ends text entry.

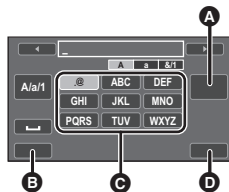

- Ⓐ [Delete]
- Ⓑ [RETURN]
- Ⓒ Text entry icon
- Ⓓ [Enter]

- A maximum of 32 characters can be entered.

Setting up a connection manually

- When connecting by [Set Manually], confirm the SSID (Identification name), Authentication method, Encryption type, and Encryption key (Password) of the wireless access point you are using.

- 1 Press the USER button to which [Wi-Fi] is registered, and turn on the Wi-Fi function.**
- 2 Select the menu.**

: [Wi-Fi Setup] → [Set Wireless Access Point]

- Touch [OK].

- 3 Touch the part with no display of a wireless access point.**

- For information on how to delete wireless access points or change the display order of wireless access points, please refer to [Set Wireless Access Point] on page 129.

- 4 Touch [Set Manually].**

- 5 Touch [INPUT], then enter the SSID of the wireless access point to be connected.**

- For details on how to enter characters, refer to page 124.
- When the entry is complete, touch [Enter].

- 6 Touch the desired Network Authentication method.**

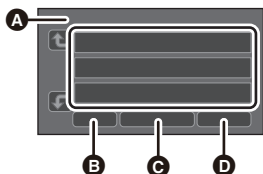

- Ⓐ [Set Wireless Access Point]
- Ⓑ [RETURN]
- Ⓒ [Delete]
- Ⓓ [EXIT]

Network authentication type	Encryption types that can be set
[Open]	[NONE]/[WEP]
[WEP]	There is no setup of an encryption types.
[WPA-PSK]/[WPA2-PSK]	[TKIP]/[AES]

- When [WEP] is selected, proceed according to step 8.

7 Touch the desired Encryption method.

- If you select [NONE], a message is displayed after completing the connection.

8 (When selecting [WEP]/[TKIP]/[AES])

Touch [INPUT], then enter the Password.

- For details on how to enter characters, refer to page 124.
- When the entry is complete, touch [Enter].
- A message is displayed when the connection is complete.

Confirming that the Wi-Fi connection is complete

-  is displayed on the screen

- Check the wireless access points instruction manual and settings when a saving wireless access point.
- The Encryption methods are [AES], [TKIP] and [WEP] in descending order of strength. We recommend you connect with the strongest possible Encryption method.
- When the signal of the wireless access point is weak, a connection may not be established. Refer to “Messages” (→ 167) and “Troubleshooting” (→ 168) for details.
- Transmission speed may decrease, or may not be usable depending on the environment it is used in.

Setting up a direct connection to a smartphone

- Register [Wi-Fi] to a USER button. (→ 61)

Check if the smartphone you are using is compatible with WPS

- If the smartphone is compatible with WPS:
Proceed to the following Connecting with WPS
- If the smartphone is not compatible with WPS:
Proceed to the following “Connecting with QR code”

Connecting with WPS

1 Press the USER button to which [Wi-Fi] is registered, and turn on the Wi-Fi function.

2 Select the menu.

 : [Wi-Fi Setup] → [Direct Connection]

3 Touch [Change connection type].

4 Touch [Easy Connection].

5 Set the smartphone to WPS Mode.

Confirming that the Wi-Fi connection is complete

-  is displayed on the screen

Connecting with QR code

- 1** Press the USER button to which [Wi-Fi] is registered, and turn on the Wi-Fi function.
- 2** Select the menu.

 : [Wi-Fi Setup] → [Direct Connection]

- 3** Touch [Change connection type].
- 4** Touch [QR code].
 - QR code is displayed on the screen of this unit.
- 5** Start up the smartphone application “Image App”.
- 6** On the smartphone, select [QR code], and scan the QR code displayed on the screen of this unit.
 - When using an Android device, the smartphone and this unit are connected directly, allowing you to use remote operations. (→ 115)
 - When using an iOS device, perform the following operations:
 - 1** Select the option that allows you to install the app on the profile screen of the “Image App”, and follow the on-screen instructions to complete the installation.
 - 2** Press the home button to close the displayed screen.
 - 3** After selecting the network name (SSID) of this unit from the Wi-Fi setup of the smartphone, start up the “Image App”.
 - When the QR code cannot be scanned, refer to “Connecting by entering an SSID and Password”.

Confirming that the Wi-Fi connection is complete

-  is displayed on the screen

Connecting by entering an SSID and Password

- 1** Press the USER button to which [Wi-Fi] is registered, and turn on the Wi-Fi function.
- 2** Select the menu.

 : [Wi-Fi Setup] → [Direct Connection]

- 3** On the smartphone, select the SSID displayed on this unit from the Wi-Fi setup menu.
- 4** Enter the Password displayed on this unit’s screen on the smartphone.

Confirming that the Wi-Fi connection is complete

-  is displayed on the screen

- Transmission speed may decrease, or may not be usable depending on the environment it is used in.

If the Wi-Fi connection cannot be established

- Please refer to the operating instruction of the device in use for details about the setting of the wireless access point or smartphone.

Problem	Check points
<p>It cannot connect to the wireless access point.</p> <p>The wireless access point is not detected.</p>	<p>(General)</p> <ul style="list-style-type: none">• Turn ON the wireless access point.• Approach the wireless access point and reconnect.• If it takes time to complete the connection, the Wi-Fi connection will be aborted. Reset the connection settings.• Check how to connect to the wireless access point and how to set the security settings.• If the wireless access point supports both the 2.4 GHz band and the 5 GHz band, check if the setting for the 2.4 GHz band is enabled.• Make sure the wireless access point is registered in this unit. (→ 129)• The device may be unable to locate the wireless access point due to problems with the signal. Refer to "Setting up a connection manually". (→ 124) <p>([Easy Connection (WPS)])</p> <ul style="list-style-type: none">• Make sure the wireless access point is in the correct WPS standby mode.• Make sure the PIN code has been correctly input. <p>([Search] or [Set Manually])</p> <ul style="list-style-type: none">• Make sure the SSID and password have been correctly input.• Check the Authentication method, Encryption type, and Encryption key (Password).
<p>Radio waves of the wireless access point get disconnected.</p>	<ul style="list-style-type: none">• The condition may improved by moving the location or changing the angle of the wireless access point.• If you use another 2.4 GHz band device such as a microwave oven or cordless telephone nearby, you may interrupt the signal. Keep a sufficient distance from these types of devices.

Problem	Check points
<p>The Wi-Fi connection is not possible between this unit and a smartphone.</p>	<p>(Wireless Access Point Connection)</p> <ul style="list-style-type: none"> ● Make sure the smartphone is properly connected to the wireless access point by checking the Wi-Fi settings of the smartphone. ● Make sure this unit and the smartphone are connected to the same wireless access point. ● Make sure the wireless access point is registered in this unit. (→ 129) <p>(Direct Connection)</p> <ul style="list-style-type: none"> ● Make sure the smartphone is properly connected to this unit by checking the Wi-Fi settings of the smartphone. ● Make sure the SSID and password have been correctly input. ● Make sure the smartphone is not connected to the wireless access point. If it is connected to the wireless access point, change the Wi-Fi access point using the smartphone's Wi-Fi set up.
<p>It takes long time every time to connect to a smartphone.</p>	<ul style="list-style-type: none"> ● It may take longer time to connect depending on the Wi-Fi connection setting of the smartphone, but it is not a malfunction.
<p>This unit is not displayed in the Wi-Fi setting screen of the smartphone.</p>	<ul style="list-style-type: none"> ● Try switching the on/off of the Wi-Fi function in the Wi-Fi settings of the smartphone.
<p>The Wi-Fi connection is disconnected immediately.</p>	<ul style="list-style-type: none"> ● If there is a setting for avoiding poor connections in the Wi-Fi setting menu of the Android device 4.0 or later version, turn it off.
<p>When I start up the “Image App” after connecting this unit to a wireless access point, the “Image App” fails to find this unit.</p>	<ul style="list-style-type: none"> ● Close the “Image App”, and disconnect the Wi-Fi connection of this unit by pressing the USER button to which [Wi-Fi] is registered. Reconnect this unit to the wireless access point, and start up the “Image App”.
<p>Cannot be connected using NFC.</p>	<ul style="list-style-type: none"> ● Make sure your smartphone is compatible with NFC. This unit can be used with NFC-compatible terminals via Android (OS version 2.3.3 or later). ● Make sure the NFC function of your smartphone is on. ● Make sure this unit is not turned off with the power switch. ● Some smartphones cannot be easily checked simply by touching. If this unit is not recognised even after touching, change positions and try again by touching slowly. ● Touch again if it does not connect after touch. If a connection still cannot be established, close the Image App, turn off this unit, and try establishing a connection again. ● If the amount of time this unit is in contact with the smartphone is too short, this unit may not recognise the smartphone. Touch and hold the smartphone.

How to Use the [Wi-Fi Setup] Menu

Configure various settings necessary to use the Wi-Fi function.

When connected to Wi-Fi, the settings cannot be changed.

- 1 Press the **USER** button to which [Wi-Fi] is registered, and turn on the Wi-Fi function.
- 2 Select the menu.

 : [Wi-Fi Setup] → desired menu item

[Wi-Fi Easy Setup]

Please refer to page 120.

[Set Wireless Access Point]

You can add or delete wireless access points, or rearrange the display order of wireless access points.

- Up to 3 wireless access points can be set.
- Please refer to page 122 for details about [Set Wireless Access Point].

To connect a wireless access point

- 1 Touch the wireless access point to connect.
- 2 Touch [EXIT].

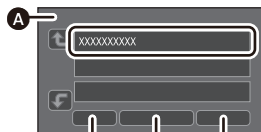

- A** [Set Wireless Access Point]
- B** [RETURN]
- C** [Delete]
- D** [EXIT]

To add a wireless access point

- 1 Touch the part where no wireless access points are displayed.
- 2 Configure the wireless access point settings.
(→ 122)

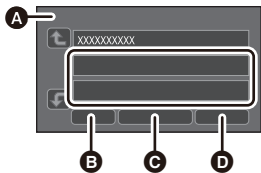



- A** [Set Wireless Access Point]
- B** [RETURN]
- C** [Delete]
- D** [EXIT]

To delete a wireless access point

- 1 Touch the wireless access point to be deleted.
- 2 Touch [Delete].

- The message is displayed. Touch [YES] to delete.

To switch the display order

- 1 Touch the access point you want to switch the order.
- 2 Switch the order by touching  or .

-
- To change the wireless access point, delete one of the registered wireless access points, and then add one.

[Direct Connection]

Please refer to page 125.

[Wi-Fi disconnect]

This will disconnect the Wi-Fi connection.

[Start up using NFC] [ON]/[OFF]

You can enable/disable the NFC function.

[Wi-Fi Password] [Setup]/[Delete]

This will set/clear the Password to limit the startup of the Wi-Fi setting menu.

By setting the Password, it will prevent erroneous operation, prevent wrongful use of the Wi-Fi function by third party, and protect the set personal information.

- 1 Touch [Setup].
- 2 Touch [INPUT], and enter the Password (6 characters).
 - After finish entering the Password, touch [Enter].
 - If the Password has already been set, ✱ is displayed.
 - For details on how to enter characters, refer to page 124.
- 3 Touch [NEXT].
- 4 Touch [INPUT], and enter the same Password again.
 - After finish entering the Password, touch [Enter].
 - If the Passwords match with each other, a message is displayed.
- 5 Touch [EXIT].

-
- If you set a Wi-Fi password, password entry is required each time you select [Wi-Fi Setup] from the menu.
 - When you forget your Wi-Fi Password, set this unit to Recording Mode, select [Wi-Fi] in [INITIAL SET], and make the initial Wi-Fi settings. (→ 160) This will set the Wi-Fi setting to the condition at the time of purchase, and you will be able to use the Wi-Fi setting menu.

[Reset Wi-Fi Settings]

You can change the Wi-Fi setting back to the default condition.

- Wi-Fi Password are also deleted.

[Device Name]

You can view and change this unit's Device name (SSID), which is used for operating this unit as a wireless access point.

1 Touch [INPUT], and enter the desired Device name (SSID).

- Input up to 20 characters are recommended. All the characters cannot be confirmed when displaying the Device names on this unit if a long Device name is used. (→ 126)
- For details on how to enter characters, refer to page 124.

2 Touch [EXIT].

- If you are going to connect directly to a smartphone after changing the Device name (SSID), set the connection again with the changed Device name (SSID). (→ 126)
- The Password entered during the setting of direct connection cannot be changed. (→ 126)

[Wireless LAN setup]

You can change or check your wireless LAN's network settings, such as the [IP Address], [Subnet Mask] and [MAC Address].

[IP Address]/[Subnet Mask]/[Gateway]/[Primary DNS]/[Secondary DNS]/[MAC Address]

- If you touch [AUTO], the network settings are configured automatically. If you touch [MANUAL], you can set each item. Select the item you want to set, and set it.
- [MAC Address] cannot be changed.

Using the Menu

Refer to page 28 for how to set up the Menu.

Camera Setup



Settings that are assigned to [SCENE1] in [CUSTOMISE SCENE] by default are indicated with underlined text.

 : [CAMERA SETUP] → desired setting

[CUSTOMISE SCENE]

- Switch to Manual Mode. (→ 34)

[SCENE1]/[SCENE2]/[SCENE3]/[SCENE4]/[SCENE5]/[SCENE6]

Preferred camera setting information can be saved to each scene file. Switch the scene file in accordance with the recording conditions.

1 Touch [CUSTOMISE SCENE].

2 Touch the scene file.

- The scene file will switch by touching [SCENE1] to [SCENE6].
- Touch [EXIT] to exit the menu screen.

3 (To change the setting of the scene file)

Change the setting of the camera setting menu.

- Following settings for camera setting menu can be stored. (→ 133 to 136)
 - [DETAIL LEVEL]
 - [V DETAIL LEVEL]
 - [DETAIL CORING]
 - [CHROMA LEVEL]
 - [CHROMA PHASE]
 - [COLOUR TEMP A ch]
 - [COLOUR TEMP B ch]
 - [MASTER PED]
 - [AUTO IRIS LEVEL]
 - [DRS]
 - [DRS EFFECT]
 - [GAMMA]
 - [KNEE]
 - [MATRIX]
 - [SKIN TONE DTL]
- Changed settings of the camera setting menu are saved in the scene file.

Default setting of the scene file

[SCENE1]	Setting appropriate for standard recording
[SCENE2]	Setting appropriate for recording considering the characteristic of fluorescent lamps (indoors, etc.)
[SCENE3]	Setting appropriate for recording with modulation in resolution, colour shade, and contrast
[SCENE4]	Setting appropriate for recording with wider gradation in dark area (dusk, etc.)
[SCENE5]	Setting appropriate for recording as a cinema with high contrast
[SCENE6]	Setting appropriate for recording as a cinema with high dynamic range

- This function's default setting is [SCENE1].
- It is possible to switch the scene file by touching **SCN1** to **SCN6** while displaying the operation icons. (→ 75)
- It will return to the default settings when [SCENE] is selected in [INITIAL SET]. (→ 160)

[DETAIL LEVEL]

Adjusts the level of the image outline correction.

- **Switch to Manual Mode.** (→ 34)
- 1 Touch **[DETAIL LEVEL]**.
 - 2 Touch **◀/▶** to adjust settings.
 - 3 Touch **[EXIT]** to exit the menu screen.

[V DETAIL LEVEL]

Adjusts the degree of vertical outline correction in images.

- **Switch to Manual Mode.** (→ 34)
- 1 Touch **[V DETAIL LEVEL]**.
 - 2 Touch **◀/▶** to adjust settings.
 - 3 Touch **[EXIT]** to exit the menu screen.

[DETAIL CORING]

Adjusts the level to eliminate the noise of the detail.

- **Switch to Manual Mode.** (→ 34)
- 1 Touch **[DETAIL CORING]**.
 - 2 Touch **◀/▶** to adjust settings.
- Setting to – direction gives crisp images but allows a slight increase in noise. Setting in the + direction reduces noise.
- 3 Touch **[EXIT]** to exit the menu screen.

[CHROMA LEVEL]

Adjusts colour density.

- **Switch to Manual Mode.** (→ 34)
- 1 Touch **[CHROMA LEVEL]**.
 - 2 Touch **◀/▶** to adjust settings.
 - 3 Touch **[EXIT]** to exit the menu screen.



[CHROMA PHASE]

Adjusts colour balance.

- **Switch to Manual Mode.** (→ 34)
- 1 Touch **[CHROMA PHASE]**.
 - 2 Touch **◀/▶** to adjust settings.
 - 3 Touch **[EXIT]** to exit the menu screen.



[COLOUR TEMP A ch]

Finely adjusts colour temperature after Ach White Balance adjustment.

- Switch to Manual Mode. (→ 34)
- 1 Touch [COLOUR TEMP A ch].
- 2 Touch  /  to adjust settings of colour.
- 3 Touch [EXIT] to complete the setting.



[COLOUR TEMP B ch]

Finely adjusts colour temperature after Bch White Balance adjustment.

- Switch to Manual Mode. (→ 34)
- 1 Touch [COLOUR TEMP B ch].
- 2 Touch  /  to adjust settings of colour.
- 3 Touch [EXIT] to complete the setting.

[MASTER PED]

Adjustment of black level based on the image is performed.

- Switch to Manual Mode. (→ 34)
- 1 Touch [MASTER PED].
- 2 Touch  /  to adjust the black level.
- 3 Touch [EXIT] to exit the menu screen.

[AUTO IRIS LEVEL]

- Switch to Manual Mode. (→ 34)
- Adjusting brightness during the Auto Iris Mode. (→ 48)

[DRS]

- Switch to Manual Mode. (→ 34)

[ON]/[OFF]

Selects the DRS (Dynamic Range Stretcher) function. (→ 67)

[DRS EFFECT]

Selects the level of the DRS function.

- Switch to Manual Mode. (→ 34)
- 1 Touch [DRS EFFECT].
- 2 Touch the desired setting item.

[1]/[2]/[3]

- Higher the value, greater the compression level of the highly illuminated area.
- Higher the value, greater the noise of the dark area.
- 3 Touch [EXIT] to exit the menu screen.



[GAMMA]

Tone or contrast of the image is set in accordance with the recorded scenes.

- Switch to Manual Mode. (→ 34)

- 1 Touch [GAMMA].
- 2 Touch the desired setting item.

[HD NORM]:	This gamma setting is suitable for high definition picture quality recording.
[LOW]:	This is a gamma setting with gradual slope at the low illuminated area. It will produce tranquil image with sharper contrast.
[SD NORM]:	This is the standard picture quality images setting.
[HIGH]:	This is a gamma setting with sharp slope at the low illuminated area. It will produce brighter image with wider gradation on the low illuminated area with softer contrast.
[B.PRESS]:	Makes the contrast sharper than [LOW].
[CINE-LIKE D]:	This is a gamma setting to make the image look like cinema.
[CINE-LIKE V]:	This is a gamma setting to make the image look like cinema with higher contrast than [CINE-LIKE D].

- Next (Previous) page can be displayed by touching  / .
- When you select [CINE-LIKE D] or [CINE-LIKE V], we recommend setting the iris darker than normal image for optimal results. (→ 48)

- 3 Touch [EXIT] to exit the menu screen.

[KNEE]

To avoid overexposure, select the compression level of the high intensity video signals received through the image sensor.

- Switch to Manual Mode. (→ 34)

- 1 Touch [KNEE].
- 2 Touch the desired setting item.

[AUTO]:	Sets up automatically depending on the signal from the image sensor.
[LOW]:	Low setting (Compression starts at approx. 80%.)
[MID]:	Medium setting (Compression starts at approx. 90%.)
[HIGH]:	High setting (Compression starts at approx. 100%.)

- 3 Touch [EXIT] to exit the menu screen.

- The unit goes to [AUTO] and the setting cannot be changed in the following cases:
 - When [DRS] is set to [ON]
 - When [GAMMA] is set to [CINE-LIKE D] or [CINE-LIKE V]

[MATRIX]

Represents the colour during the recording.

- Switch to Manual Mode. (→ 34)

- 1 Touch [MATRIX].
- 2 Touch the desired setting item.

[NORM1]:	Suitable for recording in the open air or under a halogen lamp.
[NORM2]:	Suitable for brighter colours than the [NORM1] mode.
[FLUO]:	Suitable for recording indoors under fluorescent lamp.
[CINE-LIKE]:	Suitable for cinema-like image.

- 3 Touch [EXIT] to exit the menu screen.

[SKIN TONE DTL]

- Switch to Manual Mode. (→ 34)

[ON]/[OFF]

This makes skin colours appear softer for a more attractive appearance.

This is more effective if you record a person closely from the torso up.

- 1 Touch [SKIN TONE DTL].
- 2 Touch [ON].
- 3 Touch [EXIT] to exit the menu screen.

- If the background or anything else in the scene has colours similar to the skin colour, they will also be smoothed.
- If the brightness is insufficient, the effect may not be clear.
- If you record a person in the distance, the face may not be recorded clearly. In this case, set [SKIN TONE DTL] to [OFF] or zoom in on the face (close-up) to record.

[FOCUS TRANSITION]

- Switch to Manual Mode. (→ 34)

[Setup]/[OFF]

You can register a focus position to Focus Transition. (→ 43)

- This function's default setting is [OFF].

[FOCUS TRANSITION TIME]

- **Switch to Manual Mode.** (→ 34)

[DIRECT]/[2-15 SEC.]/[20 SEC.]/[30 SEC.]/[45 SEC.]/[60 SEC.]/[90 SEC.]

You can set the length of time in which the focus will shift during Focus Transition. (→ 45)

- This function's default setting is 2 seconds.

[FOCUS TRANSITION REC]

- **Switch to Manual Mode.** (→ 34)

[1]/[2]/[3]/[OFF]

You can start recording and Focus Transition simultaneously. (→ 45)

- This function's default setting is [OFF].

[FOCUS TRANSITION WAIT]

- **Switch to Manual Mode.** (→ 34)

[0 SEC.]/[5 SEC.]/[10 SEC.]

You can set the length of time before Focus Transition starts. (→ 45)

- This function's default setting is [0 SEC.].

[Intelligent Auto Plus]

- **Switch to Intelligent Auto Mode.** (→ 36)

[SET]/[OFF]

You can adjust the brightness and colour balance in Intelligent Auto Mode. (→ 36)

- This function's default setting is [OFF].

[FLASH BAND COMPENSATION]

- **Switch to Manual Mode.** (→ 34)

[ON]/[OFF]

If you set this item to [ON], you can compensate for and reduce flash band, a phenomenon that creates markedly different levels of luminance between the top and bottom of the image when recording is performed in an environment where another camera is firing its flash. (→ 71)

- This function's default setting is [OFF].

[AREA MODE]

[INH]/[FOCUS]/[IRIS]/[Y GET]/[FOCUS/IRIS]/[FOCUS/Y GET]

You can set an Area Mode effect. (→ 68)

- This function's default setting is [FOCUS/IRIS].

[AGC LIMIT]

- **Switch to Manual Mode.** (→ 34)

[3dB]/[6dB]/[9dB]/[12dB]/[15dB]/[18dB]/[21dB]/[24dB]

Sets the maximum possible gain value for Auto Gain Mode. (→ 50)

- This function's default setting is [6dB].

[SUPER GAIN]

- **Switch to Manual Mode.** (→ 34)

[27dB]/[30dB]

Sets the gain value for the USER button function [SUPER GAIN]. (→ 50)

- This function's default setting is [27dB].

[FOCUS ASSIST]

[EXPAND]/[PEAKING]/[BOTH]

Sets the Focus Assist method. (→ 40)

- This function's default setting is [BOTH].

[PEAKING COLOUR]

[Red]/[Blue]/[Yellow]/[White]

You can set the peaking colour for Focus Assist. (→ 42)

- This function's default setting is [Red].

[PEAKING LEVEL]

You can set the peaking strength for Focus Assist. (→ 42)

Recording Setup



All default settings are indicated with underlined text.

: [RECORD SETUP] → desired setting

[MEDIA SELECT]

[SD CARD 1] and [SD CARD 2] can be selected separately to record motion pictures or still pictures. (→ 30)

[REC MODE]

Switch the recording mode of the motion pictures to record.

<u>[MOV(LPCM)]</u> *:	This recording method is suitable for editing images.
<u>[MP4(LPCM)]</u> *:	This MP4 recording method is suitable for editing images.
<u>[MP4]</u> *:	This recording method is suitable for playback and editing on a PC.
<u>[AVCHD]</u> :	This recording method is suitable for playback on a high-definition TV.

* It is not compatible with motion pictures recorded in AVCHD.

[REC FORMAT]

Switch the picture quality of the motion pictures to record.

Depending on the settings of [SYSTEM FREQ] (→ 159) and [REC MODE], the available [REC FORMAT] settings differ.

■ How to read a [REC FORMAT] setting

Items that make up a [REC FORMAT] setting represent Size, Frame rate, and Bit rate. (Excluding the [REC FORMAT] settings that are available when [REC MODE] is set to [AVCHD])

4K / 50p 150M
A B C

- A Size
- B Frame rate
- C Bit rate

- Smoother motion picture can be recorded with the higher value for the frame rate. [i] and [p] of the frame rate means interlace and progressive respectively.

Interlace (interlacing scanning)

Video signal that divides the effective scanning lines to half and send them alternatively

Progressive (progressive scanning)

High density video signal sending the effective scanning lines simultaneously (It will be higher quality image than the interlace)

- When [SYSTEM FREQ] is set to [59.94Hz(NTSC)], displayed frame rates differ from the actual ones.

Displayed frame rate	Actual frame rate
60p	59.94p
60i	59.94i
30p	29.97p
24p*	23.98p

* The actual frame rate will be 24.00p when [REC FORMAT] is set to [C4K/24p 100M].

- The higher the bit rate value is, the higher the picture quality becomes, except for when the recording format is $\frac{ALL-I}{200M}$ (This exception is due to a difference in compression method).
 - It can record with highest quality image in this unit when set to [4K/50p 150M] or [4K/60p 150M].
 - When the recording format is $\frac{ALL-I}{200M}$, recording is performed with ALL-Intra. ALL-Intra is a compression method that compresses each frame. This method results in larger file sizes, but it can minimize the deterioration in picture quality that occurs during editing.
 - The required SD card speed class differs depending on the [REC MODE] setting and the bit rate of [REC FORMAT]. Use an SD card that meets the settings. For details, refer to "About the Speed Class ratings for recording motion pictures" on page 20.
- When [MOV(LPCM)] in [REC MODE] is selected

Recording format	System frequency setting	Size (Picture size)	Frame rate	Bit rate (VBR)	
[FHD/50p $\frac{ALL-I}{200M}$]	[50Hz(PAL)]	FHD (1920×1080)	50p	Average 200 Mbps	
[FHD/50p 100M]				Average 100 Mbps	
[FHD/50p 50M]				Average 50 Mbps	
[FHD/25p $\frac{ALL-I}{200M}$]			25p	Average 200 Mbps	
[FHD/25p 50M]				Average 50 Mbps	
[FHD/60p $\frac{ALL-I}{200M}$]	[59.94Hz(NTSC)]		60p	Average 200 Mbps	
[FHD/60p 100M]				Average 100 Mbps	
[FHD/60p 50M]				Average 50 Mbps	
[FHD/30p $\frac{ALL-I}{200M}$]				30p	Average 200 Mbps
[FHD/24p $\frac{ALL-I}{200M}$]				24p	
[FHD/30p 50M]		30p		Average 50 Mbps	
[FHD/24p 50M]		24p			

● When [MP4(LPCM)] in [REC MODE] is selected

Recording format	System frequency setting	Size (Picture size)	Frame rate	Bit rate (VBR)
[C4K/24p 100M]*	[59.94Hz(NTSC)]/ [50Hz(PAL)]	C4K (4096×2160)	24p	Average 100 Mbps
[4K/50p 150M]	[50Hz(PAL)]	4K (3840×2160)	50p	Average 150 Mbps
[4K/25p 100M]			25p	Average 100 Mbps
[FHD/50p ^{ALL-I} _{200M}]		FHD (1920×1080)	50p	Average 200 Mbps
[FHD/50p 100M]				Average 100 Mbps
[FHD/50p 50M]				Average 50 Mbps
[FHD/25p ^{ALL-I} _{200M}]		25p	Average 200 Mbps	
[FHD/25p 50M]			Average 50 Mbps	
[4K/60p 150M]		[59.94Hz(NTSC)]	4K (3840×2160)	60p
[4K/30p 100M]	30p			Average 100 Mbps
[4K/24p 100M]	24p			
[FHD/60p ^{ALL-I} _{200M}]	60p		Average 200 Mbps	
[FHD/60p 100M]			Average 100 Mbps	
[FHD/60p 50M]			Average 50 Mbps	
[FHD/30p ^{ALL-I} _{200M}]	30p		Average 200 Mbps	
[FHD/24p ^{ALL-I} _{200M}]	24p			
[FHD/30p 50M]	30p		Average 50 Mbps	
[FHD/24p 50M]	24p			

* The system frequency will be set to 24.00 Hz when [C4K/24p 100M] is set.

● When [MP4] in [REC MODE] is selected

Recording format	System frequency setting	Size (Picture size)	Frame rate	Bit rate (VBR)
[4K/25p 100M]	[50Hz(PAL)]	4K (3840×2160)	25p	Average 100 Mbps
[FHD/50p 50M]		FHD (1920×1080)	50p	Average 50 Mbps
[4K/30p 100M]	[59.94Hz(NTSC)]	4K (3840×2160)	30p	Average 100 Mbps
[FHD/60p 50M]		FHD (1920×1080)	60p	Average 50 Mbps

- When [AVCHD] in [REC MODE] is selected

Recording format	System frequency setting	Picture size	Frame rate	Bit rate (VBR)
[PS 1080/50p]	[50Hz(PAL)]	1920×1080	50p	Maximum 28 Mbps
[PH 1080/50i]			50i	Maximum 24 Mbps
[HA 1080/50i]		Average 17 Mbps		
[HE 1080/50i]		Average 5 Mbps		
[PM 720/50p]		1440×1080	50p	Average 8 Mbps
		1280×720		
[PS 1080/60p]	[59.94Hz(NTSC)]	1920×1080	60p	Maximum 28 Mbps
[PH 1080/60i]			60i	Maximum 24 Mbps
[HA 1080/60i]		Average 17 Mbps		
[HE 1080/60i]		Average 5 Mbps		
[PM 720/60p]		1440×1080	60p	Average 8 Mbps
			1280×720	

■ About the [REC FORMAT] setting when [SYSTEM FREQ] has been changed

If you change the system frequency when [REC MODE] is set to [MOV(LPCM)], [MP4(LPCM)] or [MP4], [REC FORMAT] will be changed to a setting that matches the system frequency you have set. (The frame rate will be changed.)

- The setting does not change when set to [C4K/24p 100M].

System frequency setting	59.94Hz(NTSC)	50Hz(PAL)
Frame rates in [REC FORMAT]	60p	50p
	30p	25p
	24p	25p*

* If you set [REC FORMAT] to a setting with a frame rate of 25p when [SYSTEM FREQ] is set to [50Hz(PAL)], [REC FORMAT] will be changed to a setting with a frame rate of 30p.

● Recordable time using the battery (→ 16)

- Please refer to page 177 about approximate recordable time.
- When the unit is moved a lot or moved quickly, or when a fast-moving subject is recorded, mosaic-type noise may appear at playback. (Only when recording AVCHD scenes)
- In the following cases, this unit will be restarted to switch the system frequency:
 - When you have changed [REC FORMAT] from [C4K/24p 100M] to a different setting.
 - When you have changed [REC FORMAT] from a setting other than [C4K/24p 100M] to [C4K/24p 100M]

[2 SLOTS FUNC.]

You can set the auto switch recording, simultaneous recording and background recording.

- **Insert SD cards to card slot 1 and card slot 2.**

[OFF]:	Cancel the setting.
[AUTO SW] ^{*1} :	Set the auto switch recording
[SIMULTANEOUS]:	Set the auto simultaneous recording
[BACKGROUND] ^{*1, 2} :	Set the background recording



*1 This effect cannot be set for Interval Recording.

*2 This function is not available in the following cases:

- When [REC FORMAT] is set to a setting with a size of C4K (4096×2160) or 4K (3840×2160)
- When the bit rate of [REC FORMAT] is above 50 Mbps

■ Auto switch recording

This is simple Relay Recording. It is possible to continuously record on the SD card in the other card slot even when the available capacity of the SD card runs out during the recording. Note that there will be a momentary pause in the sound when recording media is switched.

-  is displayed beside the display of the SD card selected as the recording destination of motion pictures in [MEDIA SELECT] (→ 30). When the recording media is switched and auto switch recording starts,  will disappear from the location and instead be displayed beside the other SD card display.
- Even after switching of the recording media, you can replace the SD card that ran out of space with a new one and record the motion picture onto three or more SD cards. Since it may take a while for this unit to recognise a new SD card, replace the SD card that ran out of space when the SD card currently being used as a destination still has sufficient remaining recordable time.

■ Simultaneous recording

Same motion picture can be recorded on two SD cards.

-  is displayed beside the display of the SD card selected as the recording destination of motion pictures in [MEDIA SELECT] (→ 30).
- If you set the recording destination of motion pictures to [SD CARD 1] in [MEDIA SELECT], they will also be recorded to [SD CARD 2] simultaneously.
- We recommend that you perform simultaneous recording using SD cards of the same Speed Class rating and capacity.
- Simultaneous recording is not possible when different types of SD cards (SDHC Memory Card/SDXC Memory Card) are used.

■ Background recording

You can continue recording a motion picture by recording it on the SD card that is not set as a recording destination in [MEDIA SELECT] (→ 30).

- When the recording destination of motion pictures is set to [SD CARD 1] in [MEDIA SELECT] (→ 30), [SD CARD 2] will be used for background recording. The following instructions assume that the recording destination of motion pictures is set to [SD CARD 1].
-  is displayed beside the SD card display for card 2.

How to use background recording

- Register [BACKGROUND] to a USER button. (→ 61)

1 Press the recording start/stop button to start recording.

- A motion picture will start being recorded to the two SD cards. (📷 will be displayed in red.)
- If you press the USER button to which [BACKGROUND] is registered, you can start recording only to the SD card in card slot 2.
- For information on how to register a function to USER buttons, refer to page 61. For information on how to use the USER button to which [BACKGROUND] is registered, refer to page 71.

2 Press the recording start/stop button again to stop recording.

- Recording to the SD card in card slot 1 will stop, but recording to the SD card in card slot 2 will continue.
- You can repeat recording to the SD card in card slot 1 by pressing the recording start/stop button.
- You can stop background recording by pressing and holding the USER button to which [BACKGROUND] is registered.

(Auto switch recording)

- Destination to record still pictures will be switched to other SD card after performing the auto switch recording. In addition, a message about the remaining card capacity will be displayed. Replace the SD card that ran out of space or set [2 SLOTS FUNC.] to [OFF].

(Simultaneous recording)

- Simultaneous recording will not be performed for still pictures.
- When performing simultaneous recording, even in the case where an error has occurred in one of the SD cards and recording has stopped, recording can be continued using the other SD card.
- When one of the media reaches its maximum recording time, the simultaneous recording stops.

(Background recording)

- An alert sound is not emitted for background recording.
- If you record still pictures, their picture quality will differ from that during normal still picture recording.
- Background recording stops in the following cases:
 - When you have turned off this unit
 - When the SD card being used as a background recording destination runs out of space
- If the SD card being used as a background recording destination runs out of space during motion picture recording, background recording does not restart automatically even if you replace the SD card.

[TIME LAPSE REC]

A scene that moves slowly for long period of time is recorded frame by frame with an interval, and is recorded as a short time motion picture.

One frame is recorded every recording interval that is set.

- The number of frames per second differs depending on the frame rate of [REC FORMAT].
 - When the frame rate is set to 50i or 25p: 25 frames for a scene of 1 second
 - When the frame rate is set to 60i or 30p: 30 frames for a scene of 1 second
 - When the frame rate is set to 24p: 24 frames for a scene of 1 second
- **Switch to Manual Mode.** (→ 34)

[OFF]:

Cancel the setting.

[1 SEC.]/[10 SEC.]/[30 SEC.]/[1 MINUTE]/[2 MINUTES]:

Change the recording interval.

-  appears on the screen.
- After recording, the setting of Interval Recording is cancelled.
- Audio cannot be recorded.

Setup example	Setup time (recording interval)	Recording time	Recorded time
Sunset	1 s	1 h	2 min
Blooming	30 s	3 h	12 s

- “h” is an abbreviation for hour, “min” for minute and “s” for second.
- These times are approximations.
- Maximum recordable time is 12 hours.

- Still picture recording cannot be used.
- This function is not available during Freeze Frame. (→ 67)
- When Interval Recording is set, the [REC FORMAT] setting changes as follows. In addition, the settings for [REC MODE] and [REC FORMAT] cannot be changed.
 - When [REC FORMAT] is set to [C4K/24p 100M]:
You cannot change this setting to another one.
 - When the size of the [REC FORMAT] setting is 4K (3840×2160):
[4K/25p 100M]^{*1} or [4K/30p 100M]^{*2}
 - When the size of the [REC FORMAT] setting is FHD (1920×1080):
[FHD/25p 50M]^{*1} or [FHD/30p 50M]^{*2}
 - When [REC FORMAT] is set to [AVCHD]:
[HA 1080/50i]^{*1} or [HA 1080/60i]^{*2}
- *1 When [SYSTEM FREQ] (→ 159) is set to [50Hz(PAL)]
- *2 When [SYSTEM FREQ] is set to [59.94Hz(NTSC)]
- When [REC MODE] is set to [MP4] and [REC FORMAT] is set to [FHD/50p 50M] or [FHD/60p 50M], Time Lapse Recording is not possible.
- [TIME LAPSE REC] is cancelled in the following cases.
 - If you turn the unit off
 - If you press the THUMBNAIL button
- The shortest motion picture recording time is approx. 1 second.
- Colour balance and focus may not be adjusted automatically depending on light sources or scenes. If so, manually adjust these settings. (→ 39, 46)
- We recommend connecting the AC adaptor to this unit when recording images for a long period of time.
- When Interval Recording is set, this unit cannot be set to Intelligent Auto Mode even if you slide the i/MANU switch.

[PRE-REC]

[ON]/[OFF]

This allows the recording of an image and audio to start before you press the recording start/stop button. AVCHD scenes will be recorded from approximately 3 seconds before the operation, while MOV/MP4 will be recorded from approximately 4 seconds before the operation.



-  appears on the screen.
- **Aim the unit at the subject beforehand.**
- There is no beep sound.
- This function is not available in the following cases:
 - During the Interval Recording
 - When [2 SLOTS FUNC.] is set to [BACKGROUND] (→ 143)
 - When the Wi-Fi function is turned on by pressing the USER button to which [Wi-Fi] is registered. (→ 69)
- PRE-REC is cancelled in the following cases.
 - Press the USER button to which [Wi-Fi] is registered, and turn on the Wi-Fi function.
 - After 3 hours have passed
- Even when [PRE-REC] is set to [ON], if the length of time from when you display the recording screen or set this unit to Recording Mode by turning it on or pressing the THUMBNAIL button to when you start recording is too short, a 3 second image prior to the recording of an AVCHD scene or a 4 second image prior to the recording of an MOV/MP4 scene may not be recorded.
- Images displayed on the thumbnail in Playback Mode will differ from the motion pictures displayed at the start of playback.

[INFRARED REC]

- **Switch to Manual Mode.** (→ 34)

[ON]/[OFF]

You can record images even in the dark by setting this item to [ON].

-  appears on the screen.
- The iris, gain, and shutter speed are adjusted automatically.
- When [SLOW SHUTTER] is set to [ON], the shutter speed will be automatically adjusted to 1/30, 1/24 or 1/25. (→ 148)
- If you set [INFRARED LIGHT] to [ON],  will be displayed on the screen. The light allows you to record images in the dark. (→ 69, 152)
- Set [INFRARED LIGHT] to [OFF] when it is hard to achieve focus with Auto Focus, for example when recording in a dim place.
- It is recommended to use a tripod.
- It takes longer to focus with Auto Focus in dark locations.
- Do not use this function in a bright location. Doing so may cause malfunction.
- Do not cover the infrared light with your hand or other object.
- The maximum distance that the infrared light can reach is approximately 3 m.
- You can record a clear image by positioning the centre area of the screen over the subject.
- The following operations cancel the [INFRARED REC] setting:
 - Turning off this unit
 - Pressing the THUMBNAIL button

- When [INFRARED REC] is set to [ON], this unit cannot be set to Intelligent Auto Mode even if you slide the i/MANU switch.
- When [INFRARED REC] is set to [ON], focus values may not be displayed correctly. (→ 39)
- The shadow of the external microphone may appear on the edge of the screen, depending on its type or the way it is attached. (→ 12)

[TIME STAMP]

[ON]/[OFF]

You can stamp the date and time of recording on the images you record.

- **[R]** appears on the screen.
-
- The display mode and format of the date and time of recording to be stamped vary depending on the settings for [DATE/TIME] and [DATE FORMAT].
 - The month of the date and time of recording is recorded in English.
 - In the following cases, even when [TIME STAMP] is set to [ON], the date and time of recording are not displayed:
 - When [DATE/TIME] is set to [OFF]
 - During Freeze Frame (→ 67)
 - Even when [VIDEO OUT OSD] is set to [OFF], the date and time of recording are displayed on the TV screen.
 - It is not possible to stamp the date and time of recording during normal still picture recording.
 - The date and time of recording displayed during [TIME STAMP] recording and the date and time displayed during the playback of the image may not exactly be the same.

[i.Zoom]

- Set [REC FORMAT] to a setting with a picture size of 1920×1080 or below. (→ 139)

[ON]/[OFF]

This zoom function allows you to maintain high-definition picture quality. (Up to 40×)

- This function is not available in the following cases:
 - When [REC FORMAT] is set to a setting with a size of C4K (4096×2160) or 4K (3840×2160)
 - During the Interval Recording

[HYBRID O.I.S.]

[ON]/[OFF]

You can set the Hybrid Optical Image Stabilizer. (→ 38)

[SLOW SHUTTER]

[ON]/[OFF]

You can record bright pictures even in dark places by slowing the shutter speed. Slow Shutter works in Auto Shutter Mode. (→ 51)

- The shutter speed will be adjusted to one of the following values according to the ambient brightness. The value will differ depending on the frame rate of the [REC FORMAT].

Frame rates in [REC FORMAT]	Shutter speed
50p/50i/25p	1/25 or more
60p/60i/30p	1/30 or more
24p	1/24 or more

- When the shutter speed becomes 1/30, 1/24 or 1/25, the screen may be seen as if frames are missed and after images may appear.

[DIGITAL ZOOM]

[×2]/[×5]/[×10]/[TOGGLE]

Changes the zoom magnification setting of Digital Zoom. (→ 65)

[AUDIO LOW CUT CH1]

[ON]/[OFF]

Reduces the level of low-pitched sound for audio channel 1.

- You may not see the full effect depending on the recording conditions.

[AUDIO LOW CUT CH2]

[ON]/[OFF]

Reduces the level of low-pitched sound for audio channel 2.

- You may not see the full effect depending on the recording conditions.

[AUDIO LEVEL CH1]

[AUTO]/[MANUAL]

Switches the adjustment method of the audio recording level for audio channel 1. (→ 55)

[AUDIO LEVEL CH2]

[AUTO]/[MANUAL]

Switches the adjustment method of the audio recording level for audio channel 2. (→ 55)

[AUDIO ALC LINKED]

- Set [AUDIO LEVEL CH1]/[AUDIO LEVEL CH2] to [MANUAL]. (→ 55)
- Set [AUDIO ALC CH1]/[AUDIO ALC CH2] to [ON]. (→ 56)

[ON]/[OFF]

If you set this item to [ON], when ALC works for either of the audio channels, it will also work for the other audio channel. (→ 56)

[AUDIO ALC CH1]

[ON]/[OFF]

If you set this item to [ON], you can reduce the audio noise of audio channel 1. It will record with natural sound when set to [OFF]. (→ 56)

[AUDIO ALC CH2]

[ON]/[OFF]

If you set this item to [ON], you can reduce the audio noise of audio channel 2. It will record with natural sound when set to [OFF]. (→ 56)

[INPUT1 LINE LEVEL]

[+4dBu]/[0dBu]

Sets the input level of the audio equipment connected to the audio input terminal 1 (XLR 3 pin).

[INPUT2 LINE LEVEL]

[+4dBu]/[0dBu]

Sets the input level of the audio equipment connected to the audio input terminal 2 (XLR 3 pin).

[INPUT1 MIC LEVEL]

[-40dB]/[-50dB]/[-60dB]

Sets the input level of the external microphone connected to the audio input terminal 1 (XLR 3 pin).

[INPUT2 MIC LEVEL]

[-40dB]/[-50dB]/[-60dB]

Sets the input level of the external microphone connected to the audio input terminal 2 (XLR 3 pin).

TC/UB SETUP



All default settings are indicated with underlined text.

 : [TC/UB SETUP] → desired setting

[TC MODE]

- Set [SYSTEM FREQ] to [59.94Hz(NTSC)]. (→ 159)

[DF]/[NDF]

Select the compensation mode for the time code. (→ 58)

- This item will be automatically set to [NDF] and will not be displayed as a menu item when [SYSTEM FREQ] is set to [50Hz(PAL)]. (→ 159)

[TCG]

[FREE RUN]/[REC RUN]

Sets the way the time code will move. (→ 58)

[TC PRESET]

Initial value of the time code can be set. (→ 59)

[UB PRESET]

- Set [REC MODE] to [AVCHD]. (→ 139)

User Information can be set. (→ 59)

Switch setting



All default settings are indicated with underlined text.

 : [SW SETUP] → desired setting

[IRIS RING]

Sets the rotation direction and iris control of the iris ring.

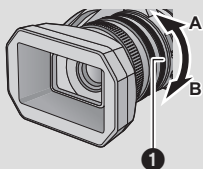

[DOWN OPEN]: Iris will open when it is turned toward B.

[UP OPEN]: Iris will open when it is turned toward A.

1 Iris ring

[USER BUTTON SETUP]

Sets the function to assign to the USER buttons. (→ 61)

[SUB REC BUTTON]

Enable/disable of the sub recording start/stop button on the handle can be switched.

[ON]: The sub recording start/stop button is enabled.

[OFF]: The sub recording start/stop button is disabled.

[SUB ZOOM]

Enable/disable of the sub zoom lever on the handle can be switched. Zoom speed will be different depending on the setting.

[OFF]: Sub zoom lever is disabled.

[LOW]: Sub zoom lever is enabled. (Zoom speed: Slow)

[MID]: Sub zoom lever is enabled. (Zoom speed: Standard)

[HIGH]: Sub zoom lever is enabled. (Zoom speed: Fast)

[INFRARED LIGHT]

You can turn on/off the infrared light when [INFRARED REC] (→ 146) is set to [ON].



- **Switch to Manual Mode.** (→ 34)

[ON]: Turn on the infrared light.

[OFF]: Turn off the infrared light.

[BARS TYPE]

You can switch the type of colour bars to be displayed when you press the BARS button. (→ 72)

[SMPTE]:	Colour bars compliant with SMPTE	
[EBU]:	Colour bars compliant with EBU	

Display setting

Different menu items are displayed depending on whether this unit is in Recording Mode or Playback Mode.

All default settings are indicated with underlined text.

: [DISP SETUP] → desired setting

[USER BUTTON DISPLAY]





[ON]/[OFF]

Switches the display of the set USER button icons. (→ 62)

[ZEBRA DETECT 1]



Selects the brightness level of the left-leaning zebra patterns on the screen.

- 1 Touch [ZEBRA DETECT 1].
 - Touch [YES].
 - 2 Touch  /  to adjust settings.
 - 3 Touch [ENTER].
- Touch [EXIT] to exit the menu screen.



- This function's default setting is 80%.

[ZEBRA DETECT 2]



[SET]/[OFF]

Selects the brightness level of the right-leaning zebra patterns on the screen.

- 1 Touch [ZEBRA DETECT 2].
 - Touch [SET].
 - 2 Touch  /  to adjust settings.
 - 3 Touch [ENTER].
- Touch [EXIT] to exit the menu screen.
 - Zebra 2 can be displayed by pressing the ZEBRA button after setting. (→ 74)

- This function's default setting is 100%.

[MARKER]



[ON]/[OFF]

Displaying of the luminance level display marker can be switched.

- Marker can be displayed by pressing ZEBRA button when set to [ON]. (→ 74)

[GUIDE LINES]



[≡]/[⊕]/[⊞]/[OFF]

You can check if the image is level while recording motion pictures and still pictures. The function can also be used to estimate the balance of the composition.

- The guidelines do not appear on the images actually recorded.
- The setting changes as follows when using Focus Assist. (→ 40)
 - The guidelines are not displayed. (these are displayed on the TV when this unit is connected to TV.)
 - The setting cannot be changed.

[SAFETY ZONE]



Display of the range that can be displayed with the common household TV (safety zone **A**) can be switched.

[16:9 90%]/[4:3]/[14:9]/[1.85:1]/[17:9]/[2:1]/[2.35:1]/
[2.39:1]/[OFF]

- The safety zone is not displayed on the images that is actually recorded.

(When [16:9 90%] is set)



[CENTER MARKER]



[ON]/[OFF]

Displays/hides the centre marker.

[REC COUNTER]



[TOTAL]/[SCENE]

Selects the operation of the Recording Counter during recording. (→ 60)

[VIDEO OUT OSD]



[ON]/[OFF]

The information displayed on the screen (operation icon and counter display etc.) can be displayed/not displayed on the TV. (→ 92)

[DATE/TIME]



[OFF]/[TIME]/[DATE]/[DATE&TIME]

It is possible to change the date and time display mode.

[DATE FORMAT]



[Y/M/D]/[M/D/Y]/[D/M/Y]

It is possible to change the date format.

[LEVEL GAUGE]



[ON]/[OFF]

This function displays the horizontal/vertical tilt of the unit with the electronic level. (→ 70)

[HISTOGRAM]



[ON]/[OFF]

A graph with brightness as horizontal axis and number of pixels at that brightness as vertical axis is displayed. It is possible to determine the exposure of the whole image by looking at the distribution in the graph. (→ 66)

[AUDIO LEVEL METER]



• (In Playback Mode)

Touch the play mode select icon, and set this unit to Motion Picture Playback Mode. (→ 79)

[ON]/[OFF]

Select to display the audio level meter.

[LENS STATUS]



[ON]/[OFF]

Display relating to lens can be switched. (Zoom Display, Optical Image Stabilizer, Focus Display, White Balance, Iris, Gain, Auto Iris, Shutter Speed)

[CARD & BATTERY]



[ON]/[OFF]

Display can be switched between the remaining recordable time of the SD card and the remaining battery capacity indication.

[OTHER DISPLAY]



[ON]/[OFF]

This shows or hides indications on the screen except for [USER BUTTON DISPLAY], [GUIDE LINES], [SAFETY ZONE], [CENTER MARKER], [DATE/TIME], [AUDIO LEVEL METER], [LENS STATUS] and [CARD & BATTERY].

[POWER LCD]



[+1]* (Makes brighter) / [0]* (Normal) / [-1]* (Makes less bright)

This makes it easier to view the LCD monitor in bright places including outdoors. (→ 24)

[LCD SET]



It adjusts brightness and colour density on the LCD monitor. (→ 25)

[EVF SET]



[BRIGHT]/[NORMAL]/[DARK]

Brightness of the viewfinder can be switched. (→ 25)

[SELF SHOOT]



[MIRROR]/[NORMAL]

Switches the mirror function of the LCD monitor when recording yourself. (→ 26)

The image on the LCD monitor is displayed mirrored horizontally during recording of yourself when it is set to [MIRROR].

[EVF COLOUR]



[ON]/[OFF]

The recording images or playback images on the viewfinder can be selected between colour/black and white. (→ 26)

[EVF/LCD DETAIL]

[ON]/[OFF]

Setting this item to [ON] helps you achieve focus easier by emphasizing the outlines of an image displayed on the LCD monitor and viewfinder. (→ 40)

[EVF/LCD PEAK LEVEL]

Adjusts the emphasis strength for [EVF/LCD DETAIL]. (→ 40)

[EVF/LCD PEAK FREQ.]

[HIGH]/[LOW]

Sets the peaking frequency for [EVF/LCD DETAIL]. (→ 40)

AV output setting

Different menu items are displayed depending on whether this unit is in Recording Mode or Playback Mode.

All default settings are indicated with underlined text.

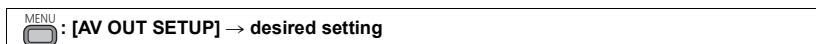

[HDMI RESOLUTION]



[AUTO]/[2160p]/[1080p]/[1080i]/[720p]/[DOWN CONV.]

Select the desired method of HDMI output. (→ 92)

[DOWN CONV.]



This function allows you to select how to display images with a 16:9 aspect ratio on a TV with a 4:3 aspect ratio.

[SIDE CROP]/[LETTERBOX]/[SQUEEZE]

[H/PHONE MODE]



Selects the sound heard through the headphones.

[LIVE]: The sound which has been input from the microphone is output as is. This setting is selected when delays in the sound are annoying.

[RECORDING]: The sound in the status which is to be recorded (the sound synchronised with the images) is output.

- When this unit is connected to a TV using the HDMI cable (supplied), audio at the time of the [RECORDING] setting is output even if this setting is set to [LIVE].

[VOLUME]



[ON]/[OFF]

If you set this item to [ON], you can adjust the headphone volume in Recording Mode using the multi-function dial. (→ 78)

[TEST TONE]



Selects the sound heard through the headphones. (→ 72)

[OFF]: Does not output a test tone.

[LEVEL 1]: Outputs a high volume test tone.

[LEVEL 2]: Outputs a low volume test tone.

[HDMI TC OUTPUT]



[ON]/[OFF]

Switches the output setting of time code information when this unit is connected to another device (HDMI-SDI converter, etc.) with an HDMI cable.

Other Functions

Different menu items are displayed depending on whether this unit is in Recording Mode or Playback Mode.

All default settings are indicated with underlined text.



[OTHER FUNCTION] → **desired setting**

[FORMAT MEDIA]



The SD card or USB HDD can be formatted. (→ 30, 104)

- Please be aware that if a medium is formatted, then all the data recorded on the medium will be erased and cannot be restored. Back up important data on a PC etc. (→ 93)

[MEDIA STATUS]



The used space and remaining recordable time of the SD card can be checked.

- Touching [CHANGE MEDIA] switches the unit between the display for the SD card 1 and the display for the SD card 2.
 - Only in Recording Mode, remaining recordable time for the selected recording format is displayed.
 - Touch [EXIT] to close the indication.
-
- The SD card requires some space to store information and manage system files, so the actual usable space is slightly less than the indicated value. The usable space is generally calculated as 1 GB=1,000,000,000 bytes. The capacities of this unit, PCs and software are expressed as 1 GB=1,024×1,024×1,024=1,073,741,824 bytes. Therefore, the indicated value of the capacity appears to be smaller.

[REC LAMP]



[FRONT]/[REAR]/[BOTH]/[OFF]

The recording lamp lights up during recording. When this is set to [OFF], it does not light during recording.

[RING LED (BLUE)]



[ON]/[5 SEC.]/[OFF]

The ring LED lights up blue in Recording Mode.

- When [5 SEC.] is set, the ring LED lights up for 5 seconds after the unit is turned on or the Recording Mode is switched.
- When [RING LED (RED)] is set to [ON], the ring LED does not light up blue during recording.

[RING LED (RED)]



[ON]/[OFF]

The ring LED lights up red during recording.

- When the [REC LAMP] is set to [OFF], this item cannot be set.

[CLOCK SET]



Set date and time. (→ 27)

[TIME ZONE]



Set the time difference from Greenwich Mean Time. (→ 27)

[SYSTEM FREQ]



Set the system frequency of this unit. Change the setting when creating a motion picture that has a broadcasting system different from that of your region.

[59.94Hz(NTSC)]: System frequency for regions where the TV broadcasting system is NTSC

[50Hz(PAL)]: System frequency for regions where the TV broadcasting system is PAL

- After you have changed the system frequency, this unit will be restarted.

- By default, the system frequency is set to the broadcasting system of the region where this product was purchased.
- This function's default setting is [50Hz(PAL)].
- **When [SYSTEM FREQ] is set to a broadcasting system different from that of your region, images may not be played back correctly on the TV.**
- **If you are not familiar with broadcasting systems, we recommend that you use the default setting.**
- When recording with [REC MODE] set to [AVCHD], you cannot record scenes of different system frequencies into a single SD card. Use a different SD card for each system frequency.

[ALERT SOUND]



[OFF]/ (Volume low)/ (Volume high)

Touch screen operation, start and stop of recording can be confirmed with this sound.

2 Beeps for 4 times

When an error occurs. Check the sentence displayed on the screen. (→ 167)

[ECONOMY (BATT)]



[ON]/[OFF]

When about 5 minutes have passed without any operation, this unit automatically turns off to save battery life.

- This unit will not automatically turn off even if the [ECONOMY (BATT)] is set to [ON] in following cases:
 - When [USB MODE] (→ 161) is set to [DEVICE] and this unit is connected to a PC or Blu-ray disc recorder with a USB Connection Cable.
 - PRE-REC is used
 - During remote operation

[ECONOMY (AC)]



[ON]/[OFF]

When connected to AC adaptor about 15 minutes have passed without any operation, this unit automatically turns off.

- This unit will not automatically turn off even if the [ECONOMY (AC)] is set to [ON] in following cases:
 - When [USB MODE] (→ 161) is set to [DEVICE] and this unit is connected to a PC or Blu-ray disc recorder with a USB Connection Cable.
 - PRE-REC is used
 - During remote operation

[INITIAL SET]



The menu settings, Wi-Fi settings or [CUSTOMISE SCENE] are reset to the default. (→ 132)

[ALL]:	This is for initialising all menus.*1
[SCENE]:	This is for initialising the setting of customise scene.
[Wi-Fi]:	You can change the Wi-Fi setting back to the default condition.*2
[NO]:	This is for not performing initialization.

*1 Settings for [REC MODE], [REC FORMAT], [MEDIA SELECT], [CLOCK SET], [SYSTEM FREQ] and [LANGUAGE] will not be changed.

*2 The Wi-Fi password will also be deleted.

- Returning all settings to the default is not possible during Freeze Frame. (→ 67)

[NUMBER RESET]



Set the file number of the MOV/MP4 and still picture recorded next to 0001.

- Folder number is updated and file number will start from 0001. (→ 96)
- To reset the folder number, format the SD card, and then perform [NUMBER RESET].

[USB MODE]



The unit's USB terminal to which a USB cable will be connected can be switched. Switch the terminal according to the shape of the USB cable's plug you intend to connect to the unit.

[DEVICE]: For connecting to the USB terminal (Type Micro-B) of the unit

[HOST]: For connecting to the USB terminal (Type A) of the unit

[SYSTEM INFO]



The version of the firmware of this device is displayed.

[UPDATE]



The firmware of this device is updated.

For the latest update information, check the support website below. (As of September 2014)

http://panasonic.jp/support/global/cs/e_cam
(This Site is English only)

[OPERATION TIME]



The accumulated operating time of this device is displayed.

[LANGUAGE]



You can select the language on the screen display and the menu screen.

Wi-Fi setting



If you press the USER button to which [Wi-Fi] is registered in Recording Mode, you can set items in the [Wi-Fi Setup] menu. Please refer to page 61 for details about setting the USER button. All default settings are indicated with underlined text.

- 1 Press the USER button to which [Wi-Fi] is registered, and turn on the Wi-Fi function.**
- 2 Select the menu.**

 : [Wi-Fi Setup] → desired setting

[Wi-Fi Easy Setup]

Using the smartphone app "Image App", you can transfer clock information and wireless access point information (SSID and password) between a smartphone and this unit. (→ 120)

[Set Wireless Access Point]

You can add or delete wireless access points, or rearrange the display order of wireless access points. (→ 123, 129)

[Direct Connection]

You can set up a direct connection between this unit and a smartphone. (→ 125)

[Wi-Fi disconnect]

This will disconnect the Wi-Fi connection.

[Start up using NFC]

[ON]/[OFF]

You can enable/disable the NFC function.

[Wi-Fi Password]

This will set/clear the Password to limit the startup of the Wi-Fi setting menu. By setting the Password, it will prevent erroneous operation, prevent wrongful use of the Wi-Fi function by third party, and protect the set personal information. (→ 130)

[Reset Wi-Fi Settings]

You can change the Wi-Fi setting back to the default condition.

- Wi-Fi Password is also deleted.

[Device Name]

You can view and change this unit's Device name (SSID), which is used for operating this unit as a wireless access point. (→ 131)

[Wireless LAN setup]

You can change or check your wireless LAN's network settings, such as the [IP Address], [Subnet Mask] and [MAC Address]. (→ 131)

Video Setup



All default settings are indicated with underlined text.

- Press the **THUMBNAIL** button to switch this unit to the **Playback Mode**.
- Touch the play mode select icon, and set this unit to **Motion Picture Playback Mode**. (→ 79)

: **[VIDEO SETUP]** → desired setting

[REPEAT PLAY]

[ON]/[OFF]

Playback of the first scene starts after playback of the last scene finishes when set to [ON]. (→ 85)

[RESUME PLAY]

[ON]/[OFF]

If playback of a scene was stopped halfway, the playback can be resumed from where it was stopped when set to [ON]. (→ 86)

[SCENE PROTECT]

Scenes can be protected so that they are not deleted by mistake.

(Even if you protect some scenes, formatting the SD card will delete them.) (→ 88)

[DELETE]

Deletes a scene. (→ 87)

Picture Setup



- Press the **THUMBNAIL** button to switch this unit to the **Playback Mode**.
- Touch the play mode select icon, and set this unit to **Still Picture Playback Mode**. (→ 79)

: **[PHOTO SETUP]** → desired setting

[SCENE PROTECT]

Still pictures can be protected so that they are not deleted by mistake.

(Even if you protect some still pictures, formatting the SD card will delete them.) (→ 88)

[DELETE]

Deletes a still picture. (→ 87)

Indications

■ Recording indications

Example: Display in English

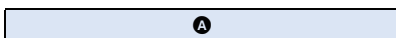
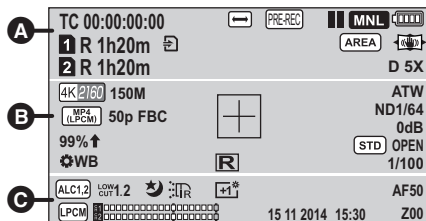

TC 00:00:00:00

Counter display (→ 57)

Interval Recording (→ 144)

PRE-REC (→ 146)

Recording

Recording pause

Intelligent Auto Mode (→ 34)

Intelligent Auto Plus Mode (→ 36)

Intelligent Auto Plus Mode (→ 36)

Manual Mode (→ 34)

Remaining battery power (→ 18)

Recording to card possible (motion picture)

Card is being recognised (motion picture)

R 1h20m Remaining time for motion picture recording (→ 31)

Auto switch recording (→ 143)

Simultaneous recording (→ 143)

Background recording (→ 143)

Area Mode (→ 68)

Freeze Frame (→ 67)

Image Stabilizer (→ 38)

D 2X, D 5X, Digital Zoom (→ 65)

D 10X

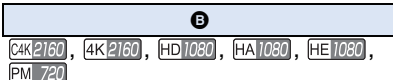

Recording format (→ 139)

ALL-I, 150M, 100M, 50M

Bit rate (→ 139)

ATW, LOCK, P3200K, P5600K, VAR, Ach, Bch

White Balance (→ 46)















Recording mode (→ 139)







60p, 60i, 50p, Frame rate (→ 139)

50i, 30p, 25p,

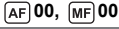
24p

FBC Flash band compensation (→ 71, 137)

ND 1/4,	ND filter (→ 73)
ND 1/16,	
ND 1/64	
99% ↑	Luminance level (→ 68, 74)
	Luminance display frame (→ 74)
	Centre Marker (→ 154)
AGC, 0dB	Gain value (→ 49)
	Auto iris mode (→ 48)
	Backlight Compensation (→ 64)
	Spotlight (→ 64)
OPEN, F2.0	Iris value (→ 48)
	Multi Manual Function (→ 77)
	Time Stamp recording in progress (→ 147)
1/100	Shutter speed (→ 51)
1/100.0	Synchro Scan (→ 52)
	
	When [AUDIO ALC CH1] is enabled (→ 56)
	When [AUDIO ALC CH2] is enabled (→ 56)
	When [AUDIO ALC CH1], [AUDIO ALC CH2] are enabled (→ 56)
	When [AUDIO ALC CH1], [AUDIO ALC CH2], [AUDIO ALC LINKED] are enabled (→ 56)
LOW CUT 1	When [AUDIO LOW CUT CH1] is enabled (→ 148)
LOW CUT 2	When [AUDIO LOW CUT CH2] is enabled (→ 148)
LOW CUT 1.2	When [AUDIO LOW CUT CH1], [AUDIO LOW CUT CH2] are enabled (→ 148)
	Infrared recording (→ 146)
	Infrared light (→ 69, 152)
	Power LCD (→ 24)

	Focus Transition bar (→ 44)
AF50, MF50,	Focus (→ 39)
	
	Audio recording method (→ 53)
	
	Audio level meter (→ 55)
15 11 2014	Date indication
15:30	Time indication (→ 27)
15 NOV 2014 15:30:00	
Time Stamp (→ 147)	
Z00, Z99	Zoom magnification (→ 37)
1, 2	Card recording possible status (still picture)
	Number of recording pixels for still pictures (→ 32, 85)
In Playback Mode, the picture size is not displayed for still pictures recorded with other products that have different picture sizes from the sizes shown above.	
R3000	Remaining number of still pictures (→ 32)
 (Red)	Recording still picture

■ Playback indications



Display during playback (→ 79, 83)

TC 00:00:00:00

Counter Display (→ 57)

No.10 Scene Number (In Playback Mode)

No.0010 Scene Number (In 1-scene display in thumbnail mode)

15:30 Time indication (→ 27)

15 11 2014 Date indication

Repeat Playback (→ 85)

Resume Playback (→ 86)

100-0001 Still picture folder/file name

Protected motion pictures/still pictures (→ 88)



Recording mode (When thumbnails are displayed) (→ 79)



Recording format (When thumbnails are displayed) (→ 79, 139)

10 Scene Number (In 9-scene display in thumbnail mode) (→ 79)

■ Indication of connection to Wi-Fi

, Wi-Fi connection status (wireless access point) (→ 120)

, Wi-Fi connection status (Direct connection) (→ 120)

■ Indication of connection to USB HDD

USB HDD Playback (→ 106)

■ Indication of connection to other devices

Accessing the card (→ 94, 109)

■ Confirmatory indications

-- (Time display) The built-in battery is low. (→ 27)

Warning for recording of yourself (→ 26)

SD card is not inserted.

SD card is write-protected.

SD card is non-compatible.

SD card is full.

Playback-only SD card

Messages

Major confirmation/error messages to be indicated on the screen in text.

CHECK CARD.

This card is not compatible or it cannot be recognised by the unit.

If this message appears even though motion pictures and still pictures are recorded on an SD card, the card may be unstable. Reinsert the SD card, then turn the unit off and then on again.

INVALID/CANNOT SET.

Since there is a condition to use the function, it is required to cancel/change other settings.

THIS EXTERNAL DRIVE CANNOT BE USED./ PLEASE CHECK THE EXTERNAL DRIVE.

The external drive that this unit cannot recognise is connected. Check if the USB HDD can be connected and used with this unit and try to reconnect. (→ 102)

No wireless access point found/Connection failed. Please check network settings of connected device.

- Check the Wi-Fi set up of your wireless access point and smartphone.
- [Easy Connection (WPS)] can establish a connection only between two devices: this unit and a device that will connect to this unit. Check if multiple devices are trying to establish a connection in the WPS waiting state simultaneously.
- Read page 127 if the Wi-Fi connection cannot be established.

About recovery

If faulty management information is found, the messages may appear and a repair is performed. (Repairing may take time depending on the error.)

-  is displayed when abnormal management information is detected when the scenes are displayed in thumbnail.
- Use a sufficiently charged battery or the AC adaptor.
- Depending on the condition of the data, it may not be possible to completely repair the data.
- If recovery fails, it will not be possible to play back scenes recorded before the unit turned off.
- When data recorded on another device is recovered, it may not be possible to play back the data on this unit or the other device.
- If recovery fails, turn the unit off and on again after waiting awhile. If recovery fails repeatedly, format a media on the unit. Please be aware that if a media is formatted, then all the data recorded on the media will be erased.
- If the thumbnail information is recovered, displaying the thumbnails may become slower.

Troubleshooting

■ It is not a malfunction in following cases

The lens, the viewfinder or LCD monitor fog up.	<ul style="list-style-type: none"> This is due to condensation. It is not a breakdown. Please refer to page 2.
A clicking sound is heard when the unit is shaken.	<ul style="list-style-type: none"> This is the sound of the lens moving and is not a defect. This sound will no longer be heard when the unit is turned on and switch to Recording Mode.
Object seems to be warped.	<ul style="list-style-type: none"> Object seems to be warped slightly when the object moves across the image very fast, but this is because the unit is using MOS for the image sensor. This is not a malfunction.

Power

Problem	Check points
<p>This unit cannot be turned on.</p> <p>This unit does not stay on long enough.</p> <p>Battery runs down quickly.</p>	<ul style="list-style-type: none"> Charge the battery again to ensure it is sufficiently charged. (→ 14) In cold places, the battery using time becomes shorter. The battery has a limited life. If the operating time is still too short even after the battery is fully charged, the battery has worn out and needs to be replaced.
<p>This unit cannot be operated though it is turned on.</p> <p>This unit does not operate normally.</p>	<ul style="list-style-type: none"> Remove the battery or AC adaptor, wait about 1 minute and then reconnect the battery or AC adaptor. Then about 1 minute later, turn on the unit again. (Conducting the above operation while the media is being accessed may damage the data on the media.) If normal operation is still not restored, detach the power connected, and consult the dealer who you purchased this unit from.
<p>“ERROR OCCURRED. PLEASE TURN UNIT OFF, THEN TURN ON AGAIN.” is displayed.</p>	<ul style="list-style-type: none"> The unit has automatically detected an error. Restart the unit by turning off and on. The unit will be turned off in about 1 minute if the unit is not turned off and on. Repair is needed if it is repeatedly displayed even if it is restarted. Detach the power connected, and consult the dealer who you purchased this unit from. Do not attempt to repair the unit by yourself.



Indication

Problem	Check points
Function display (Remaining Display, Counter Display, etc.) is not displayed.	<ul style="list-style-type: none"> ● [CARD & BATTERY] or [OTHER DISPLAY] of the [DISP SETUP] is [OFF]. (→ 155) ● Press the COUNTER button to switch the counter display. (→ 57)

Recording

Problem	Check points
The unit arbitrarily stops recording.	<ul style="list-style-type: none"> ● Use an SD card that can be used for motion picture recording. (→ 20) ● The recordable time may have shortened due to the deterioration of the data writing speed or repeated recording and deletion. Using the unit, format the SD card. (→ 30)
Auto Focus function does not work.	<ul style="list-style-type: none"> ● Switch to Intelligent Auto Mode. ● If you are trying to record a scene which is hard to bring into focus in Auto Focus Mode, use the Manual Focus Mode to adjust the focus. (→ 35, 39)
Colour or brightness of the image changes, or you may see horizontal bars in the image. The LCD monitor flickers indoors.	<ul style="list-style-type: none"> ● Colour or brightness of the image may change, or you may see horizontal bars in the image when the object is recorded under fluorescent light, mercury light or sodium light, etc., but this is not a malfunction. ● Record images in Intelligent Auto Mode or adjust the shutter speed to 1/50, 1/60 or 1/100. ● Adjust the Synchro Scan shutter speed. (→ 52)

Playback

Problem	Check points
Scenes/still pictures cannot be played back.	<ul style="list-style-type: none"> ● Any scenes/still pictures where the thumbnails are displayed as  cannot be played back.
Scenes/still pictures cannot be deleted.	<ul style="list-style-type: none"> ● Release the protect setting. (→ 88) ● Any scenes/still pictures where the thumbnails are displayed as  cannot be deleted. If the scenes/still pictures are unnecessary, format the media to erase the data. (→ 30) Please be aware that if a media is formatted then all the data recorded on the media is erased and cannot be recovered. Back up important data on a PC etc.

With other products

Problem	Check points
<p>Although this unit is correctly connected to a TV, images cannot be seen.</p> <p>The images are squeezed horizontally.</p>	<ul style="list-style-type: none"> ● Please read the operating instructions of your TV and select the channel that matches the input used for the connection. ● Change the setting of the unit depending on the cable connecting to the TV. (→ 91)
<p>Even when this unit is connected to the TV by the HDMI cable, images or sounds are not output.</p>	<ul style="list-style-type: none"> ● Check if the HDMI cable is connected correctly. ● Insert the HDMI cable all the way in.
<p>If the SD card is inserted in another device, it is not recognised.</p>	<ul style="list-style-type: none"> ● Check that the device is compatible with the capacity or type of SD card (SDHC Memory Card/SDXC Memory Card) that you inserted. Refer to the operating instructions of the device for details. ● To play back scenes in the recording format option [4K/50p 150M], you need a TV that supports 4K/50p. (→ 89, 92)
<p>When connected by the USB cable, this unit is not detected by the other devices.</p>	<ul style="list-style-type: none"> ● When connected to other devices using only the battery, reconnect using the AC adaptor.

With a PC

Problem	Check points
<p>When connected by the USB cable, this unit is not detected by the PC.</p>	<ul style="list-style-type: none"> ● After re-inserting the SD card into the unit, reconnect the supplied USB cable. ● Select another USB terminal on the PC. ● Check the operating environment. (→ 94, 99) ● Connect the supplied USB cable again after restarting the PC and turning on this unit again.
<p>When the USB cable is disconnected, an error message will appear on the PC.</p>	<ul style="list-style-type: none"> ● To disconnect the USB cable safely, double-click the  icon in the task tray and follow the instructions on the screen.
<p>Cannot see the PDF operating instructions for HD Writer XE 2.0.</p>	<ul style="list-style-type: none"> ● You will need Adobe Acrobat Reader 5.0 or later or Adobe Reader 7.0 or later to read the PDF operating instructions for HD Writer XE 2.0.

About the Wi-Fi function

Problem	Check points
<p>Cannot connect to wireless access point or smartphone.</p>	<ul style="list-style-type: none"> ● Read page 127 if the Wi-Fi connection cannot be established.

About the Wi-Fi function

Problem	Check points
Cannot operate from smartphone using remote operation.	<ul style="list-style-type: none"> Install the smartphone app "Image App" on your smartphone. (→ 119)
I have forgotten the password for the Wi-Fi.	<ul style="list-style-type: none"> Perform [Reset Wi-Fi Settings] from the Setup menu (→ 131). This will set the Wi-Fi setting to the condition at the time of purchase, and you will be able to use the Wi-Fi setting menu. When performing [Reset Wi-Fi Settings], all Wi-Fi settings including registered wireless access points will be deleted.

Others

Problem	Check points
If the SD card is inserted in this unit, it is not recognised.	<ul style="list-style-type: none"> If the SD card is formatted on a PC, it may not be recognised by this unit. Use this unit to format SD cards. (→ 30)

■ If AVCHD scenes do not change smoothly when played back on another device

The images may be still for several seconds at the joins between the scenes if the following operations are performed when multiple scenes have been continuously played back using another unit.

- Just how smoothly the scenes will be played back depends on the playback unit. Depending on the unit used, the images may stop moving and become still for a moment even when none of the following conditions are applicable.
- A continuous recording of motion picture data that exceeds 4 GB may momentarily stop at every 4 GB of data when played back with another device.
- It may not play back smoothly when the editing of scenes was done with the HD Writer XE 2.0, but it will play back smoothly if you set the seamless settings in the HD Writer XE 2.0. Refer to the operating instructions for the HD Writer XE 2.0.

Principal reasons for not playing back smoothly

<ul style="list-style-type: none"> The recording format [PS] was switched to another recording format when a scene was recorded
<ul style="list-style-type: none"> When the scenes were recorded on different dates
<ul style="list-style-type: none"> When scenes lasting under 3 seconds have been recorded
<ul style="list-style-type: none"> When PRE-REC was used for recording
<ul style="list-style-type: none"> When the Time Lapse Recording is used
<ul style="list-style-type: none"> When deleting scenes
<ul style="list-style-type: none"> When scenes recorded more than 99 scenes on the same date

Cautions for use

About this unit

The unit and the SD card become warm during use. This is not a malfunction.

Keep this unit as far away as possible from electromagnetic equipment (such as microwave ovens, TVs, video games etc.).

- If you use this unit on top of or near a TV, the pictures and/or sound on this unit may be disrupted by electromagnetic wave radiation.
- Do not use this unit near cell phones because doing so may result in noise adversely affecting the pictures and/or sound.
- Recorded data may be damaged, or pictures may be distorted, by strong magnetic fields created by speakers or large motors.
- Electromagnetic wave radiation generated by microprocessors may adversely affect this unit, disturbing the pictures and/or sound.
- If this unit is adversely affected by electromagnetic equipment and stops functioning properly, turn this unit off and remove the battery or disconnect AC adaptor. Then reinsert the battery or reconnect AC adaptor and turn this unit on.

Do not use this unit near radio transmitters or high-voltage lines.

- If you record near radio transmitters or high-voltage lines, the recorded pictures and/or sound may be adversely affected.

Make sure to use the supplied cords and cables. If you use optional accessories, use the cords and the cables supplied with them.

Do not extend the cords and the cables.

Do not spray insecticides or volatile chemicals onto the unit.

- If the unit is sprayed with such chemicals, its body may be marred and the surface finish may peel off.
- Do not leave rubber or plastic products in contact with the unit for a long time.

When you use the unit in a sandy or dusty place such as a beach, do not let sand or fine dust get into the body and terminals of the unit.

Also, keep the unit away from sea water.

- Sand or dust may damage the unit. (Care should be taken when inserting and removing a card.)
- If sea water splashes onto the unit, wipe off the water with a well wrung cloth. Then wipe the unit again with a dry cloth.

When carrying the unit, do not drop or bump it.

- A strong impact can break the unit's casing, causing it to malfunction.
- When carrying this unit, please hold the grip belt or shoulder strap firmly and treat it with care.

Cleaning

- Before cleaning, detach the battery or pull the AC cable from the AC outlet, and then wipe the unit with a soft, dry cloth.
- If the unit is very dirty, dip a cloth in water and squeeze firmly, and then wipe the unit with the damp cloth. Next, dry the unit with a dry cloth.
- Use of benzine, paint thinner, alcohol, or dishwashing liquid may alter the camera body or peel the surface finish. Do not use these solvents.
- When using a chemical dust cloth, follow the instructions that came with the cloth.

When you are not going to use the unit for an extended time

- When storing the unit in a cupboard or cabinet, it is recommended that you place a desiccant (silica gel) in with it.

Do not lift up this unit by the handle with the tripod still attached

- When the tripod is attached, its weight will also affect the unit's handle, possibly causing the handle to break and hurting the user.
- To carry the unit while the tripod is attached, take hold of the tripod.

Do not swing the unit around, shake it by, or allow it hang from the handle

- Do not jar, swing, or shake the unit by its handle. Any strong jolt to the handle may damage the unit or result in personal injury.

Do not allow the cord to drag on the ground or pull a connected cord along the passage

- The cord will be damaged, causing fire or electrical shock, when the cord gets caught by the feet, excite will also cause personal injury.

Do not use this unit for purposes that require a long period of time, such as surveillance.

- This may cause heat build-up within this unit. Malfunction may result.

About the battery

The battery used in this unit is a rechargeable lithium-ion battery. It is susceptible to humidity and temperature and the effect increases the more the temperature rises or falls. In cold areas, the full charge indication may not appear or the low battery indication may appear about 5 minutes after starting use. At high temperatures, the protection function may be triggered, making it impossible to use the unit.

Be sure to detach the battery after use.

- If the battery is left attached, a minute amount of current continues to flow even if the unit is off. Keeping the unit in this state may result in over discharge of the battery. This may result in you not being able to use the battery even after it is charged.
- The battery should be stored in the vinyl bag so metal does not come into contact with the terminals.
- The battery should be stored in a cool place free from humidity, with as constant temperature as possible. (Recommended

temperature: 15 °C to 25 °C, Recommended humidity: 40%RH to 60%RH)

- Extremely high temperatures or low temperatures will shorten the life of the battery.
- If the battery is kept in high-temperature, high-humidity, or oily-smoky places, the terminals may rust and cause malfunctions.
- To store the battery for a long period of time, we recommend you charge it once every year and store it again after you have completely used up the charged capacity.
- Dust and other matter attached to the battery terminals should be removed.

Prepare spare batteries when going out for recording.

- Prepare batteries enough to last for 3 to 4 times the period you are planning to record for. Cold places such as a ski resort can shorten recording time.

If you drop the battery accidentally, check to see if the terminals are damaged.

- When this unit or battery charger is attached with the terminal part in a deformed state, this unit or battery charger may be damaged.

Do not throw old battery into fire.

- Heating a battery or throwing it into a fire may result in an explosion.

If the operating time is very short even after the battery has been recharged, the battery has worn out. Please purchase a new battery.

About the AC adaptor/battery charger

- If the temperature of the battery is extremely high or extremely low, charging may take time or the battery may not be charged.
- If the charging lamp keeps flashing, make sure that the terminals of the battery or the battery charger are not exposed to dirt, foreign objects or dust, then reconnect them properly.
Disconnect the AC cable from the AC outlet when you remove dirt, foreign objects or dust on the terminals of the battery or the battery charger.
If the charging lamp is still flashing, the temperature of the battery may be extremely high or extremely low or something may be wrong with the battery or battery charger. Contact your dealer.
- If you use the AC adaptor or battery charger near a radio, radio reception may be disturbed. Keep the AC adaptor or battery charger 1 m or more away from the radio.
- When using the AC adaptor or battery charger, it may generate whirring sounds. However, this is normal.
- After use, be sure to disconnect the AC cable from the AC outlet. (If you leave this unit connected, the AC adaptor will consume approximately 0.3 W and the battery charger approximately 0.3 W of current.)
- Always keep the electrodes of the AC adaptor, battery charger and battery clean.
- **Install the device near an AC outlet so that the power disconnection device (AC mains plug) can be accessed easily by hand.**

About the SD card

When disposing of or giving away the SD card, note that:

- Formatting and deletion of this unit or computer only changes the file management information and does not completely delete the data in the SD card.
- It is recommended that the main SD card is either physically destroyed or the SD card is physically formatted using this unit when disposing of or giving away the SD card.
- To physically format, connect this unit to the AC adaptor, select [OTHER FUNCTION] → [FORMAT MEDIA] → [SD CARD 1] or [SD CARD 2] from the menu, and touch [YES]. Press and hold recording start/stop button in the following screen for three seconds. Screen to delete the SD card data is displayed, so select [YES] and follow the instruction on the screen.

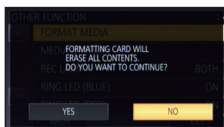

- The customer is responsible for the management of the data in the SD card.

LCD monitor/viewfinder

- When the LCD screen is dirty or condensation has occurred, please wipe it using a soft cloth such as a lens cloth.
- Do not touch the LCD monitor with your finger nails, or rub or press with strong force.
- It may become hard to see or hard to recognise the touch when the LCD protection sheet is affixed.
- When the unit has become very cold, for example due to storage in a cold area, its LCD monitor will be slightly darker than usual immediately after the unit is turned on. The normal brightness will be restored when the unit's internal temperature rises.

Extremely high precision technology is employed to produce the LCD Monitor screen. The result is more than 99.99% effective dots with a mere 0.01% of the dots inactive or always lit. However, this is not a malfunction and does not affect the recorded picture.

Extremely high precision technology is employed to produce the viewfinder screen. The result is more than 99.99% effective dots with a mere 0.01% of the dots inactive or always lit. However, this is not a malfunction and does not affect the recorded picture.

About personal information

When the Wi-Fi function is used, the SSID, Password, and other personal information will be included in this unit.

Setting a Wi-Fi password is recommended to protect personal information. (→ 130)

Disclaimer

- Information including personal information may be altered or vanish due to erroneous operation, effect of static electricity, accident, malfunction, repair, or other handlings. Please note in advance that Panasonic is not liable in any way for any direct or indirect damage from the alteration or vanishing of information or personal information.

When requesting a repair, transferring to another party, or disposing.

- After making a copy of personal information, always delete information such as personal information and wireless LAN connection settings that you have saved within this unit with [Reset Wi-Fi Settings]/[INITIAL SET]. (→ 131, 160)
- Remove the Memory Card from this unit when requesting a repair.
- Settings may return to factory default when this unit is repaired.
- Please contact the dealer where you purchased this unit or Panasonic if above operations are not possible due to malfunction.

When transferring to another party, or disposing of the Memory Card, please refer to "When disposing of or giving away the SD card, note that:". (→ 174)

About copyright

■ Carefully observe copyright laws

Recording of pre-recorded tapes or discs or other published or broadcast material for purposes other than your own private use may infringe copyright laws. Even for the purpose of private use, recording of certain material may be restricted.

■ Licenses

- SDXC Logo is a trademark of SD-3C, LLC.
- "AVCHD", "AVCHD Progressive" and the "AVCHD Progressive" logo are trademarks of Panasonic Corporation and Sony Corporation.
- Manufactured under license from Dolby Laboratories. Dolby and the double-D symbol are trademarks of Dolby Laboratories.
- HDMI, the HDMI Logo, and High-Definition Multimedia Interface are trademarks or registered trademarks of HDMI Licensing LLC in the United States and other countries.
- LEICA is a registered trademark of Leica Microsystems IR GmbH and DICOMAR is a registered trademark of Leica Camera AG.
- Microsoft®, Windows® and Windows Vista® are either registered trademarks or trademarks of Microsoft Corporation in the United States and/or other countries.
- Microsoft product screen shot(s) reprinted with permission from Microsoft Corporation.
- Intel®, Pentium®, Celeron® and Intel®Core™ are trademarks of Intel Corporation in the U.S. and/or other countries.
- AMD Athlon™ is a trademark of Advanced Micro Devices, Inc.
- Final Cut Pro, Mac and OS X are trademarks of Apple Inc. registered in the U.S. and other countries.
- App Store is a service mark of Apple Inc.
- Android and Google Play are trademarks or registered trademarks of Google Inc.
- The Wi-Fi CERTIFIED™ Logo is a certification mark of Wi-Fi Alliance®.
- The Wi-Fi Protected Setup™ Identifier mark is a certification mark of Wi-Fi Alliance®.
- "Wi-Fi®" is a registered trademark of Wi-Fi Alliance®.
- "Wi-Fi Protected Setup™", "WPA™", and "WPA2™" are trademarks of Wi-Fi Alliance®.
- The N-Mark is a trademark or registered trademark of NFC Forum, Inc. in the United States and in other countries.
- QR Code is a registered trademark of DENSO WAVE INCORPORATED.
- Other names of systems and products mentioned in these instructions are usually the registered trademarks or trademarks of the manufacturers who developed the system or product concerned.

This product is licensed under the AVC patent portfolio license for the personal and non-commercial use of a consumer to (i) encode video in compliance with the AVC Standard ("AVC Video") and/or (ii) decode AVC Video that was encoded by a consumer engaged in a personal and non-commercial activity and/or was obtained from a video provider licensed to provide AVC Video. No license is granted or shall be implied for any other use. Additional information may be obtained from MPEG LA, LLC. See <http://www.mpegla.com>.

Recording modes/approximate recordable time

- SD cards are only mentioned with their main memory size. The stated times are the approximate recordable times for continuous recording.
- If recording for long periods, prepare batteries for 3 or 4 times the period you wish to record for. (→ 16)
- The default setting for [REC MODE] is [MP4(LPCM)], and the default setting for [REC FORMAT] is [4K/50p 150M].
- Maximum continuously recordable time for one scene: 10 hours
- The recording is paused once when the recording time for one scene exceeds 10 hours, and the recording will automatically resume after a few seconds.
- The recordable time may be reduced if recording with a lot of action is recorded or recording of short scene is repeated.
- For information on picture sizes, frame rates, and bit rates in [REC FORMAT], refer to page 139.
- **When [REC MODE] is set to [MOV(LPCM)]**

Recording format	System frequency setting (→ 159)	SD card		
		4 GB	16 GB	64 GB
[FHD/50p <small>ALL-I 200M</small>]	[50Hz(PAL)]	—	10 min	40 min
[FHD/25p <small>ALL-I 200M</small>]		—	20 min	1 h 20 min
[FHD/50p 100M]		10 min	40 min	2 h 40 min
[FHD/50p 50M]		—	10 min	40 min
[FHD/25p 50M]		10 min	40 min	2 h 40 min
[FHD/60p <small>ALL-I 200M</small>]	[59.94Hz(NTSC)]	—	10 min	40 min
[FHD/60p 100M]		—	20 min	1 h 20 min
[FHD/60p 50M]		10 min	40 min	2 h 40 min
[FHD/30p <small>ALL-I 200M</small>]		—	10 min	40 min
[FHD/24p <small>ALL-I 200M</small>]		10 min	40 min	2 h 40 min
[FHD/30p 50M]		10 min	40 min	2 h 40 min
[FHD/24p 50M]				

• When [REC MODE] is set to [MP4(LPCM)]

Recording format	System frequency setting (→ 159)	SD card		
		4 GB	16 GB	64 GB
[C4K/24p 100M]	[59.94Hz(NTSC)]/ [50Hz(PAL)]	—	20 min	1 h 20 min
[4K/50p 150M]	[50Hz(PAL)]	—	12 min	55 min
[4K/25p 100M]		—	20 min	1 h 20 min
[FHD/50p ^{ALL-I} _{200M}]		—	10 min	40 min
[FHD/25p ^{ALL-I} _{200M}]		—	20 min	1 h 20 min
[FHD/50p 100M]		—	20 min	1 h 20 min
[FHD/50p 50M]		10 min	40 min	2 h 40 min
[FHD/25p 50M]		—	12 min	55 min
[4K/60p 150M]		[59.94Hz(NTSC)]	—	20 min
[4K/30p 100M]	—		10 min	40 min
[4K/24p 100M]	—		20 min	1 h 20 min
[FHD/60p ^{ALL-I} _{200M}]	—		10 min	40 min
[FHD/60p 100M]	—		20 min	1 h 20 min
[FHD/60p 50M]	10 min		40 min	2 h 40 min
[FHD/30p ^{ALL-I} _{200M}]	—		10 min	40 min
[FHD/24p ^{ALL-I} _{200M}]	—		10 min	40 min
[FHD/30p 50M]	10 min		40 min	2 h 40 min
[FHD/24p 50M]	10 min		40 min	2 h 40 min

• When [REC MODE] is set to [MP4]

Recording format	System frequency setting (→ 159)	SD card		
		4 GB	16 GB	64 GB
[4K/25p 100M]	[50Hz(PAL)]	—	20 min	1 h 20 min
[FHD/50p 50M]		10 min	40 min	2 h 40 min
[4K/30p 100M]	[59.94Hz(NTSC)]	—	20 min	1 h 20 min
[FHD/60p 50M]		10 min	40 min	2 h 40 min



- When [REC MODE] is set to [AVCHD]

Recording format	System frequency setting (→ 159)	SD card		
		4 GB	16 GB	64 GB
[PS 1080/50p]	[50Hz(PAL)]	19 min	1 h 20 min	5 h 20 min
[PH 1080/50i]		21 min	1 h 30 min	6 h
[HA 1080/50i]		30 min	2 h	8 h 30 min
[HE 1080/50i]		1 h 30 min	6 h 40 min	27 h 30 min
[PM 720/50p]		1 h 10 min	4 h 40 min	19 h
[PS 1080/60p]	[59.94Hz(NTSC)]	19 min	1 h 20 min	5 h 20 min
[PH 1080/60i]		21 min	1 h 30 min	6 h
[HA 1080/60i]		30 min	2 h	8 h 30 min
[HE 1080/60i]		1 h 30 min	6 h 40 min	27 h 30 min
[PM 720/60p]		1 h 10 min	4 h 40 min	19 h

Others

Approximate number of recordable pictures

- SD cards are only mentioned with their main memory size. The stated number is the approximate number of recordable pictures.

Picture size	Aspect ratio	SD card		
		4 GB	16 GB	64 GB
 4096×2160	17:9	700	2900	11500
 3840×2160	16:9	750	3000	12000
 1920×1080		3200	12500	52000

- Maximum number of recordable pictures that can be displayed is 9999. If the number of recordable pictures exceeds 9999, R 9999+ is displayed. The number will not change when the picture is taken until the number of recordable pictures is 9999 or less.
- The memory capacity indicated on the label of an SD card is the total of the capacity for copyright protection and management and the capacity which can be used on the unit, a PC etc.

