

Nikon

DIGITAL CAMERA

D810

User's Manual



Nikon Manual Viewer 2

Use the Nikon Manual Viewer 2 app to view manuals anytime, anywhere on your smartphone or tablet.

En

To get the most from your camera, please be sure to read all instructions thoroughly and keep them where they will be read by all those who use the product.

Symbols and Conventions

To make it easier to find the information you need, the following symbols and conventions are used:



This icon marks cautions; information that should be read before use to prevent damage to the camera.



This icon marks notes; information that should be read before using the camera.



This icon marks references to other pages in this manual.

Menu items, options, and messages displayed in the camera monitor are shown in **bold**.

Camera Settings

The explanations in this manual assume that default settings are used.

Nikon Manual Viewer 2



Install the Nikon Manual Viewer 2 app on your smartphone or tablet to view Nikon digital camera manuals, anytime, anywhere. Nikon Manual Viewer 2 can be downloaded free of charge from the App Store and Google Play. Download of the app and any product manuals requires an Internet connection, for which fees may be levied by your phone or Internet service provider.

For Your Safety

Before using the camera for the first time, read the safety instructions in "For Your Safety" (☞ xiii–xvi).

Package Contents

Be sure all items listed here were included with your camera.

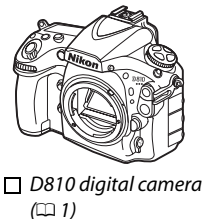

BM-12 monitor cover (10)



BF-1B body cap (15, 436)

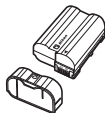

EN-EL15 rechargeable Li-ion battery with terminal cover (13, 14)



MH-25a battery charger (comes with either an AC wall adapter or power cable of a type and shape that varies with the country or region of sale; 13)

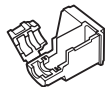

USB cable clip (258)

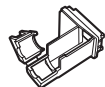

HDMI cable clip (269)

UC-E22 USB cable (257, 263)

User's Manual (this guide)

AN-DC12 strap (12)

ViewNX 2 installer CD (253)

Memory cards are sold separately. Cameras purchased in Japan display menus and messages in English and Japanese only; other languages are not supported. We apologize for any inconvenience this may cause.

Table of Contents

Package Contents.....	i
For Your Safety.....	xiii
Notices.....	xvii
Introduction	1
Getting to Know the Camera.....	1
The Multi Selector	11
First Steps	12
Camera Menus	24
Using Camera Menus.....	25
Basic Photography and Playback	29
“Point-and-Shoot” Photography.....	29
Basic Playback.....	31
Deleting Unwanted Photographs.....	33
Live View Photography	35
Focus.....	39
Manual Focus.....	41
Using the i Button	42
The Live View Display: Live View Photography.....	45
The Information Display: Live View Photography.....	46

Movie Live View	49
Indices.....	54
Using the i Button	55
The Live View Display: Movie Live View	57
The Information Display: Movie Live View	58
Image Area	59
Taking Photos During Movie Live View	60
Movie Settings	62
Viewing Movies	65
Editing Movies	67
Trimming Movies	67
Saving Selected Frames	72
Image Recording Options	74
Image Area	74
Image Quality.....	79
Image Size.....	83
Using Two Memory Cards.....	86
Focus	87
Autofocus	87
Autofocus Mode.....	87
AF-Area Mode	90
Focus Point Selection	94
Focus Lock.....	96
Manual Focus	100

Release Mode	102
Choosing a Release Mode	102
Power Source and Frame Rate	104
Self-Timer Mode (☺)	106
Mirror up Mode (MUP).....	108
ISO Sensitivity	109
Manual Adjustment	109
Auto ISO Sensitivity Control.....	111
Exposure	114
Metering.....	114
Exposure Mode	116
P: Programmed Auto	118
S: Shutter-Priority Auto.....	119
A: Aperture-Priority Auto.....	120
M: Manual.....	121
Long Time-Exposures (M Mode Only)	123
Shutter-Speed and Aperture Lock	126
Autoexposure (AE) Lock.....	128
Exposure Compensation.....	130
Bracketing	133
White Balance	148
White Balance Options	148
Fine-Tuning White Balance	151
Choosing a Color Temperature.....	155
Preset Manual	158
Viewfinder Photography	159
Live View (Spot White Balance).....	163
Managing Presets.....	167







Image Enhancement	170
<hr/>	
Picture Controls	170
Selecting a Picture Control.....	170
Modifying Picture Controls	173
Creating Custom Picture Controls.....	177
Sharing Custom Picture Controls.....	180
Preserving Detail in Highlights and Shadows	182
Active D-Lighting.....	182
High Dynamic Range (HDR)	184
Flash Photography	189
<hr/>	
Using the Built-in Flash	189
Flash Modes	191
Flash Compensation	196
FV Lock	198
Other Shooting Options	201
<hr/>	
The  Button (Viewfinder Photography)	201
The  button	205
Two-Button Reset: Restoring Default Settings.....	206
Multiple Exposure	209
Interval Timer Photography.....	216
Time-Lapse Photography	223
Non-CPU Lenses	229
Location Data.....	233
More About Playback	235
<hr/>	
Viewing Images	235
Full-Frame Playback.....	235
Thumbnail Playback	235



Photo Information.....	238
Taking a Closer Look: Playback Zoom	248
Protecting Photographs from Deletion	250
Deleting Photographs	251
Full-Frame and Thumbnail Playback.....	251
The Playback Menu	252
Connections	253
<hr/>	
Installing ViewNX 2	253
Using ViewNX 2.....	257
Copy Pictures to the Computer	257
Ethernet and Wireless Networks.....	261
Printing Photographs	263
Connecting the Printer.....	263
Printing Pictures One at a Time.....	264
Printing Multiple Pictures.....	266
Creating a DPOF Print Order: Print Set	267
Viewing Photographs on TV.....	269
HDMI Options.....	270
Menu Guide	272
<hr/>	
Defaults	272
 The Playback Menu: Managing Images	280
Playback Menu Options.....	280
Playback Folder	281
Hide Image	281
Playback Display Options	282
Copy Image(s)	283
Image Review	287
After Delete	287
Rotate Tall.....	288
Slide Show	288

 The Shooting Menu: Shooting Options.....	290
Shooting Menu Options.....	290
Shooting Menu Bank	291
Extended Menu Banks.....	292
Storage Folder.....	293
File Naming	295
JPEG/TIFF Recording.....	295
NEF (RAW) Recording	295
Color Space.....	296
Vignette Control	297
Auto Distortion Control	298
Long Exposure NR	
(Long Exposure Noise Reduction)	299
High ISO NR.....	299
 Custom Settings: Fine-Tuning Camera Settings	300
Custom Settings.....	301
Custom Settings Bank	304
a: Autofocus	306
a1: AF-C Priority Selection.....	306
a2: AF-S Priority Selection	307
a3: Focus Tracking with Lock-On.....	308
a4: AF Activation.....	308
a5: Focus Point Illumination	309
a6: AF Point Illumination	310
a7: Focus Point Wrap-Around.....	310
a8: Number of Focus Points.....	311
a9: Store by Orientation.....	312
a10: Built-in AF-assist Illuminator	313
a11: Limit AF-Area Mode Selection.....	314
a12: Autofocus Mode Restrictions	314

b: Metering/Exposure	315
b1: ISO Sensitivity Step Value.....	315
b2: EV Steps for Exposure Cntrl	315
b3: Exp./Flash Comp. Step Value.....	315
b4: Easy Exposure Compensation.....	316
b5: Matrix Metering.....	317
b6: Center-Weighted Area.....	317
b7: Fine-Tune Optimal Exposure.....	318
c: Timers/AE Lock.....	319
c1: Shutter-Release Button AE-L.....	319
c2: Standby Timer	319
c3: Self-Timer	319
c4: Monitor off Delay	320
d: Shooting/Display	321
d1: Beep.....	321
d2: CL Mode Shooting Speed.....	321
d3: Max. Continuous Release.....	322
d4: Exposure Delay Mode	322
d5: Electronic Front-Curtain Shutter.....	323
d6: File Number Sequence	324
d7: Viewfinder Grid Display.....	325
d8: ISO Display and Adjustment.....	325
d9: Screen Tips.....	325
d10: Information Display.....	326
d11: LCD Illumination.....	326
d12: MB-D12 Battery Type.....	327
d13: Battery Order	328

e: Bracketing/Flash	329
e1: Flash Sync Speed	329
e2: Flash Shutter Speed	331
e3: Flash Cntrl for Built-in Flash.....	331
e4: Exposure Comp. for Flash.....	338
e5: Modeling Flash.....	338
e6: Auto Bracketing Set.....	338
e7: Auto Bracketing (Mode M).....	339
e8: Bracketing Order	340
f: Controls.....	341
f1:  Switch.....	341
f2: Multi Selector Center Button	341
f3: Multi Selector.....	343
f4: Assign Fn Button	343
f5: Assign Preview Button	349
f6: Assign AE-L/AF-L button	349
f7: Shutter Spd & Aperture Lock	350
f8: Assign BKT Button.....	350
f9: Customize Command Dials	351
f10: Release Button to Use Dial	353
f11: Slot Empty Release Lock.....	354
f12: Reverse Indicators	354
f13: Assign Movie Record Button	355
f14: Live View Button Options	356
f15: Assign MB-D12 AF-ON	356
f16: Assign Remote (WR) Fn Button.....	357
f17: Lens Focus Function Buttons	359

g: Movie.....	361
g1: Assign Fn Button.....	361
g2: Assign Preview Button.....	362
g3: Assign AE-L/AF-L Button.....	363
g4: Assign Shutter Button.....	364
Y The Setup Menu: Camera Setup.....	365
Setup Menu Options.....	365
Format Memory Card	366
Monitor Brightness.....	367
Monitor Color Balance	368
Image Dust Off Ref Photo	369
Flicker Reduction	371
Time Zone and Date	372
Language.....	372
Auto Image Rotation	373
Battery Info.....	374
Image Comment	375
Copyright Information.....	376
Save/Load Settings	377
Virtual Horizon	379
AF Fine-Tune	380
Eye-Fi Upload	382
Firmware Version.....	383

 The Retouch Menu: Creating Retouched Copies	384
Retouch Menu Options	384
D-Lighting	388
Red-Eye Correction	389
Trim	390
Monochrome	392
Filter Effects	393
Color Balance	394
Image Overlay	395
NEF (RAW) Processing	399
Resize	401
Quick Retouch	404
Straighten	404
Distortion Control	405
Fisheye	406
Color Outline.....	406
Color Sketch	407
Perspective Control	408
Miniature Effect.....	409
Selective Color.....	410
Side-by-Side Comparison.....	412
 My Menu/ Recent Settings	414

Compatible Lenses	419
Optional Flash Units (Speedlights)	428
The Nikon Creative Lighting System (CLS).....	428
Other Accessories	436
Attaching a Power Connector and AC Adapter	442
Caring for the Camera	444
Storage.....	444
Cleaning.....	444
Image Sensor Cleaning	445
Caring for the Camera and Battery: Cautions	452
Exposure Program	458
Troubleshooting	459
Battery/Display.....	459
Shooting	460
Playback.....	464
Miscellaneous	465
Error Messages	466
Specifications	473
Approved Memory Cards	487
Memory Card Capacity	489
Battery Life	492
Lenses That May Block the Built-in Flash and AF-Assist Illuminator	494
Index	498

For Your Safety

To prevent damage to your Nikon product or injury to yourself or to others, read the following safety precautions in their entirety before using this equipment. Keep these safety instructions where all those who use the product will read them.

The consequences that could result from failure to observe the precautions listed in this section are indicated by the following symbol:



This icon marks warnings. To prevent possible injury, read all warnings before using this Nikon product.

■ ■ WARNINGS

Keep the sun out of the frame

Keep the sun well out of the frame when shooting backlit subjects. Sunlight focused into the camera when the sun is in or close to the frame could cause a fire.

Do not look at the sun through the viewfinder

Viewing the sun or other strong light source through the viewfinder could cause permanent visual impairment.

Using the viewfinder diopter adjustment control

When operating the viewfinder diopter adjustment control with your eye to the viewfinder, care should be taken not to put your finger in your eye accidentally.

Turn off immediately in the event of malfunction

Should you notice smoke or an unusual smell coming from the equipment or AC adapter (available separately), unplug the AC adapter and remove the battery immediately, taking care to avoid burns. Continued operation could result in injury. After removing the battery, take the equipment to a Nikon-authorized service center for inspection.

Do not use in the presence of flammable gas

Do not use electronic equipment in the presence of flammable gas, as this could result in explosion or fire.

Keep out of reach of children

Failure to observe this precaution could result in injury. In addition, note that small parts constitute a choking hazard. Should a child swallow any part of this equipment, consult a physician immediately.

⚠ Do not disassemble

Touching the product's internal parts could result in injury. In the event of malfunction, the product should be repaired only by a qualified technician. Should the product break open as the result of a fall or other accident, remove the battery and/or AC adapter and then take the product to a Nikon-authorized service center for inspection.

⚠ Do not place the strap around the neck of an infant or child

Placing the camera strap around the neck of an infant or child could result in strangulation.

⚠ Do not remain in contact with the camera, battery, or charger for extended periods while the devices are on or in use

Parts of the device become hot. Leaving the device in direct contact with the skin for extended periods may result in low-temperature burns.

⚠ Do not leave the product where it will be exposed to extremely high temperatures, such as in an enclosed automobile or in direct sunlight

Failure to observe this precaution could cause damage or fire.

⚠ Do not aim a flash at the operator of a motor vehicle

Failure to observe this precaution could result in accidents.

⚠ Observe caution when using the flash

- Using the camera with the flash in close contact with the skin or other objects could cause burns.
- Using the flash close to the subject's eyes could cause temporary visual impairment. The flash should be no less than one meter (3 ft 4 in.) from the subject. Particular care should be observed when photographing infants.

⚠ Avoid contact with liquid crystal

Should the monitor break, care should be taken to avoid injury due to broken glass and to prevent the liquid crystal from the monitor touching the skin or entering the eyes or mouth.

⚠ Do not carry tripods with a lens or camera attached

You could trip or accidentally strike others, resulting in injury.

⚠ Observe proper precautions when handling batteries

Batteries may leak or explode if improperly handled. Observe the following precautions when handling batteries for use in this product:

- Use only batteries approved for use in this equipment.
- Do not short or disassemble the battery.
- Be sure the product is off before replacing the battery. If you are using an AC adapter, be sure it is unplugged.
- Do not attempt to insert the battery upside down or backwards.
- Do not expose the battery to flame or to excessive heat.
- Do not immerse in or expose to water.
- Replace the terminal cover when transporting the battery. Do not transport or store the battery with metal objects such as necklaces or hairpins.
- Batteries are prone to leakage when fully discharged. To avoid damage to the product, be sure to remove the battery when no charge remains.

- When the battery is not in use, attach the terminal cover and store in a cool, dry place.
- The battery may be hot immediately after use or when the product has been used on battery power for an extended period. Before removing the battery turn the camera off and allow the battery to cool.
- Discontinue use immediately should you notice any changes in the battery, such as discoloration or deformation.

⚠ Observe proper precautions when handling the charger

- Keep dry. Failure to observe this precaution could result in injury or product malfunction due to fire or electric shock.
- Do not short the charger terminals. Failure to observe this precaution could result in overheating and damage to the charger.
- Dust on or near the metal parts of the plug should be removed with a dry cloth. Continued use could result in fire.

- Do not handle the power cable or go near the charger during thunderstorms. Failure to observe this precaution could result in electric shock.
- Do not damage, modify, or forcibly tug or bend the power cable. Do not place it under heavy objects or expose it to heat or flame. Should the insulation be damaged and the wires become exposed, take the power cable to a Nikon-authorized service representative for inspection. Failure to observe this precaution could result in fire or electric shock.
- Do not handle the plug or charger with wet hands. Failure to observe this precaution could result in injury or product malfunction due to fire or electric shock.
- Do not use with travel converters or adapters designed to convert from one voltage to another or with DC-to-AC inverters. Failure to observe this precaution could damage the product or cause overheating or fire.

 **Use appropriate cables**

When connecting cables to the input and output jacks, use only the cables provided or sold by Nikon for the purpose to maintain compliance with product regulations.

 **CD-ROMs**

CD-ROMs containing software or manuals should not be played back on audio CD equipment. Playing CD-ROMs on an audio CD player could cause hearing loss or damage the equipment.

 **Follow the directions of airline and hospital personnel**

This camera transmits radio frequencies that could interfere with medical equipment or aircraft navigation. Disable the wireless network feature and remove all wireless accessories from the camera before boarding an aircraft, and turn the camera off during take off and landing. In medical facilities, follow staff instructions regarding the use of wireless devices.

Notices

- No part of the manuals included with this product may be reproduced, transmitted, transcribed, stored in a retrieval system, or translated into any language in any form, by any means, without Nikon's prior written permission.
- Nikon reserves the right to change the specifications of the hardware and software described in these manuals at any time and without prior notice.
- Nikon will not be held liable for any damages resulting from the use of this product.
- While every effort has been made to ensure that the information in these manuals is accurate and complete, we would appreciate it were you to bring any errors or omissions to the attention of the Nikon representative in your area (address provided separately).

Notice for Customers in Canada

CAN ICES-3 B / NMB-3 B

Notices for Customers in Europe

CAUTION: RISK OF EXPLOSION IF BATTERY IS REPLACED BY AN INCORRECT TYPE. DISPOSE OF USED BATTERIES ACCORDING TO THE INSTRUCTIONS.

This symbol indicates that electrical and electronic equipment is to be collected separately.



This symbol on the battery indicates that the battery is to be collected separately.



The following apply only to users in European countries:

- This product is designated for separate collection at an appropriate collection point. Do not dispose of as household waste.
- Separate collection and recycling helps conserve natural resources and prevent negative consequences for human health and the environment that might result from incorrect disposal.
- For more information, contact the retailer or the local authorities in charge of waste management.

The following apply only to users in European countries:

- All batteries, whether marked with this symbol or not, are designated for separate collection at an appropriate collection point. Do not dispose of as household waste.
- For more information, contact the retailer or the local authorities in charge of waste management.

Notices for Customers in the U.S.A.

Power Cable

At voltages over AC 125 V (U.S.A. only): The power cable must be rated for the voltage in use, be at least AWG no. 18 gauge, and have SVG insulation or better with a NEMA 6P-15 plug rated for AC 250 V 15 A.

Federal Communications Commission (FCC) Radio Frequency Interference Statement

This equipment has been tested and found to comply with the limits for a Class B digital device, pursuant to Part 15 of the FCC rules. These limits are designed to provide reasonable protection against harmful interference in a residential installation. This equipment generates, uses, and can radiate radio frequency energy and, if not installed and used in accordance with the instructions, may cause harmful interference to radio communications. However, there is no guarantee that interference will not occur in a particular installation. If this equipment does cause harmful interference to radio or television reception, which can be determined by turning the equipment off and on, the user is encouraged to try to correct the interference by one or more of the following measures:

- Reorient or relocate the receiving antenna.
- Increase the separation between the equipment and receiver.
- Connect the equipment into an outlet on a circuit different from that to which the receiver is connected.
- Consult the dealer or an experienced radio/television technician for help.



Nikon
D810

CAUTIONS

Modifications

The FCC requires the user be notified that any changes or modifications made to this device that are not expressly approved by Nikon Corporation may void the user's authority to operate the equipment.

Interface Cables

Use the interface cables sold or provided by Nikon for your equipment. Using other interface cables may exceed the limits of Class B Part 15 of the FCC rules.

Notice for Customers in the State of California

WARNING: Handling the cord on this product may expose you to lead, a chemical known to the State of California to cause birth defects or other reproductive harm. *Wash hands after handling.*

Nikon Inc., 1300 Walt Whitman Road, Melville, New York 11747-3064, U.S.A.
Tel.: 631-547-4200

Notice Concerning Prohibition of Copying or Reproduction

Note that simply being in possession of material that has been digitally copied or reproduced by means of a scanner, digital camera, or other device may be punishable by law.

- **Items prohibited by law from being copied or reproduced**

Do not copy or reproduce paper money, coins, securities, government bonds, or local government bonds, even if such copies or reproductions are stamped "Sample."

The copying or reproduction of paper money, coins, or securities which are circulated in a foreign country is prohibited.

Unless the prior permission of the government has been obtained, the copying or reproduction of unused postage stamps or post cards issued by the government is prohibited.

The copying or reproduction of stamps issued by the government and of certified documents stipulated by law is prohibited.

- **Cautions on certain copies and reproductions**

The government has issued cautions on copies or reproductions of securities issued by private companies (shares, bills, checks, gift certificates, etc.), commuter passes, or coupon tickets, except when a minimum of necessary copies are to be provided for business use by a company. Also, do not copy or reproduce passports issued by the government, licenses issued by public agencies and private groups, ID cards, and tickets, such as passes and meal coupons.

- **Comply with copyright notices**

The copying or reproduction of copyrighted creative works such as books, music, paintings, woodcuts, prints, maps, drawings, movies, and photographs is governed by national and international copyright laws. Do not use this product for the purpose of making illegal copies or to infringe copyright laws.

Disposing of Data Storage Devices

Please note that deleting images or formatting memory cards or other data storage devices does not completely erase the original image data. Deleted files can sometimes be recovered from discarded storage devices using commercially available software, potentially resulting in the malicious use of personal image data. Ensuring the privacy of such data is the user's responsibility.

Before discarding a data storage device or transferring ownership to another person, erase all data using commercial deletion software, or format the device and then completely refill it with images containing no private information (for example, pictures of empty sky). Be sure to also replace any pictures selected for preset manual (□ 167). Before discarding the camera or transferring ownership to another person, you should also use the **Network > Network settings** option in the camera setup menu to delete any personal network information. For more information, see the documentation provided with the optional communication unit. Care should be taken to avoid injury when physically destroying data storage devices.

AVC Patent Portfolio License

THIS PRODUCT IS LICENSED UNDER THE AVC PATENT PORTFOLIO LICENSE FOR THE PERSONAL AND NON-COMMERCIAL USE OF A CONSUMER TO (i) ENCODE VIDEO IN COMPLIANCE WITH THE AVC STANDARD ("AVC VIDEO") AND/OR (ii) DECODE AVC VIDEO THAT WAS ENCODED BY A CONSUMER ENGAGED IN A PERSONAL AND NON-COMMERCIAL ACTIVITY AND/OR WAS OBTAINED FROM A VIDEO PROVIDER LICENSED TO PROVIDE AVC VIDEO. NO LICENSE IS GRANTED OR SHALL BE IMPLIED FOR ANY OTHER USE. ADDITIONAL INFORMATION MAY BE OBTAINED FROM MPEG LA, L.L.C. SEE <http://www.mpegla.com>

Use Only Nikon Brand Electronic Accessories

Nikon cameras are designed to the highest standards and include complex electronic circuitry. Only Nikon brand electronic accessories (including chargers, batteries, AC adapters, and flash accessories) certified by Nikon specifically for use with this Nikon digital camera are engineered and proven to operate within the operational and safety requirements of this electronic circuitry.

The use of non-Nikon electronic accessories could damage the camera and may void your Nikon warranty. The use of third-party rechargeable Li-ion batteries not bearing the Nikon holographic seal shown at right could interfere with normal operation of the camera or result in the batteries overheating, igniting, rupturing, or leaking.

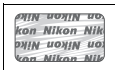

For more information about Nikon brand accessories, contact a local authorized Nikon dealer.

Use Only Nikon Brand Accessories

Only Nikon brand accessories certified by Nikon specifically for use with your Nikon digital camera are engineered and proven to operate within its operational and safety requirements. THE USE OF NON-NIKON ACCESSORIES COULD DAMAGE YOUR CAMERA AND MAY VOID YOUR NIKON WARRANTY.

Before Taking Important Pictures

Before taking pictures on important occasions (such as at weddings or before taking the camera on a trip), take a test shot to ensure that the camera is functioning normally. Nikon will not be held liable for damages or lost profits that may result from product malfunction.

Life-Long Learning

As part of Nikon's "Life-Long Learning" commitment to ongoing product support and education, continually-updated information is available on-line at the following sites:

- **For users in the U.S.A.:** <http://www.nikonusa.com/>
- **For users in Europe and Africa:** <http://www.europe-nikon.com/support/>
- **For users in Asia, Oceania, and the Middle East:** <http://www.nikon-asia.com/>

Visit these sites to keep up-to-date with the latest product information, tips, answers to frequently-asked questions (FAQs), and general advice on digital imaging and photography. Additional information may be available from the Nikon representative in your area. See the following URL for contact information: <http://imaging.nikon.com/>

Introduction

Getting to Know the Camera

Take a few moments to familiarize yourself with camera controls and displays. You may find it helpful to bookmark this section and refer to it as you read through the rest of the manual.

Camera Body

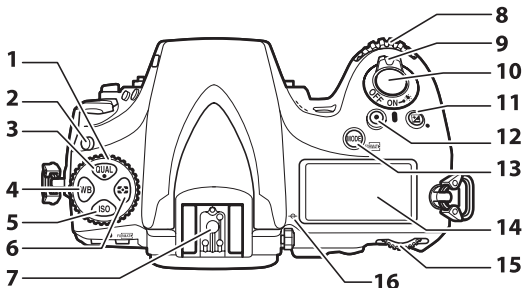

1 Release mode dial	102	8 Sub-command dial	351
2 Release mode dial lock release	102	9 Power switch	16
3 QUAL button	79, 83, 206	10 Shutter-release button	30
4 WB button	149, 153, 157	11 AF-ON button	130, 206
5 ISO button	109, 111	12 Movie-record button	52
6 Camera icon button	115	13 MODE/FORMAT button	116, 366
7 Accessory shoe (for optional flash unit)	435, 436, 479	14 Control panel	5
		15 Main command dial	351
		16 Focal plane mark (⊖)	101

Camera Body (Continued)

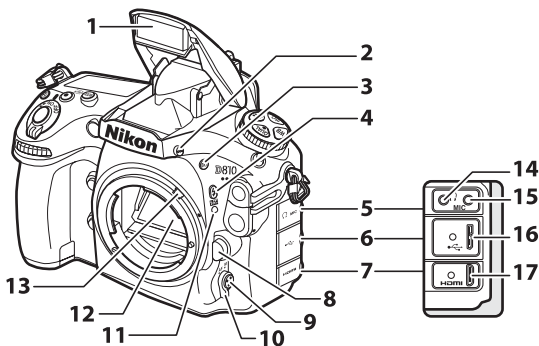

1 Built-in flash..... 189	10 Focus-mode selector 39, 87, 100
2 Flash pop-up button..... 189	11 Lens mounting mark 15
3 BKT button..... 134, 139, 143, 350	12 Mirror..... 108, 448
4 ⚡/BKT button 190, 196	13 Metering coupling lever 477
5 Audio connector cover 56, 63	14 Headphone connector..... 56
6 USB connector cover 257, 263	15 Connector for external microphone 63
7 HDMI connector cover 269	16 USB connector 257, 263
8 Lens release button..... 23	17 HDMI connector 269
9 AF-mode button 39, 41, 88, 91	

✓ The Speaker

Do not place the speaker in close proximity to magnetic devices. Failure to observe this precaution could affect the data recorded on the magnetic devices.

✓ Close the Connector Cover

Close the connector cover when the connectors are not in use. Foreign matter in the connectors can interfere with data transfer.

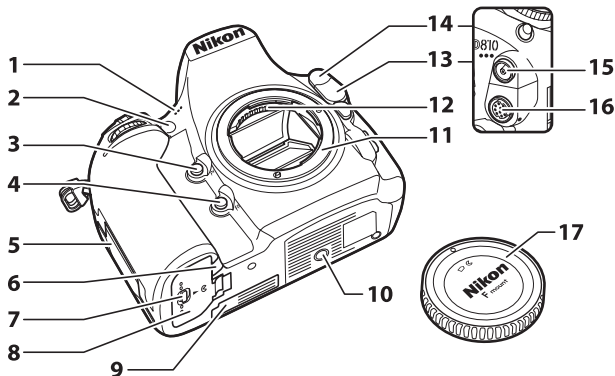

1 Stereo microphone.....49, 62	10 Tripod socket
2 AF-assist illuminator.....313	11 Lens mount 15, 101
Self-timer lamp..... 107	12 CPU contacts
Red-eye reduction lamp 191	13 Ten-pin remote terminal
3 Pv button 54, 117, 349, 362	cover 233, 439
4 Fn button..... 78, 343, 361	14 Flash sync terminal cover 429
5 Memory card slot cover..... 14, 21	15 Flash sync terminal 429
6 Power connector cover442	16 Ten-pin remote
7 Battery-chamber cover latch 14	terminal 233, 439
8 Battery-chamber cover 14	17 Body cap 15, 436
9 Contact cover for optional MB-D12 battery pack.....436	

Camera Body (Continued)

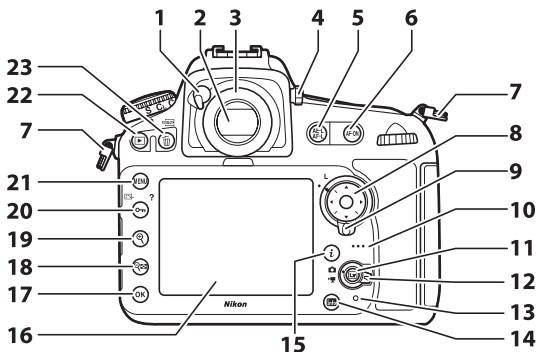

1	Eyepiece shutter lever	23, 106	13	Memory card access lamp.....	21, 30
2	Viewfinder	17	14	info (info) button	8, 201
3	Viewfinder eyepiece	23, 106	15	i button	9, 42, 55, 205, 386
4	Diopter adjustment control	17	16	Monitor	31, 35, 42, 49, 56, 235, 367
5	AF-ON button	36, 97, 128, 349, 363	17	OK (OK) button.....	25
6	AF-ON button.....	50, 88	18	button	38, 44, 235, 248
7	Eyelet for camera strap	12	19	button.....	38, 44, 235, 248
8	Multi selector.....	11, 25	20	button.....	25, 171, 250
9	Focus selector lock	94	21	MENU button	24, 272
10	Speaker	66	22	button	31, 235
11	L button	35, 49	23	button	33, 251, 366
12	Live view selector	35, 49			

The Control Panel

The control panel shows a variety of camera settings when the camera is on. The items shown here appear the first time the camera is turned on; information on other settings can be found in the relevant sections of this manual.

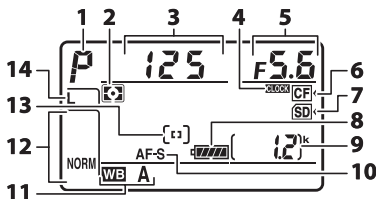

1 Exposure mode 116	9 Number of exposures remaining 20, 489
2 Metering 114	10 Focus mode 87
3 Shutter speed 119, 121	11 White balance 148
4 LOCK indicator 372	12 Image quality 79
5 Aperture (f-number) 120, 121	13 AF-area mode 90, 91
6 CompactFlash memory card indicator 14	14 Image size (JPEG and TIFF images) 83
7 SD memory card indicator 14	
8 Battery indicator 19	

The **LOCK** Indicator

The camera clock is powered by an independent, rechargeable power source, which is charged as necessary when the main battery is installed or the camera is powered by an optional power connector and AC adapter (□ 436). Two days of charging will power the clock for about three months. If the **LOCK** icon flashes in the control panel, the clock has been reset and the date and time recorded with any new photographs will not be correct. Set the clock to the correct time and date using the **Time zone and date > Date and time** option in the setup menu (□ 18).

The Viewfinder Display

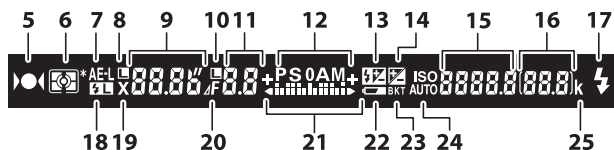
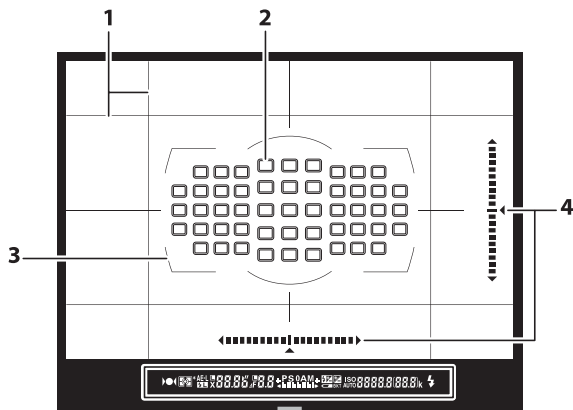

<p>1 Framing grid (displayed when On is selected for Custom Setting d7) 325</p> <p>2 Focus points.... 17, 30, 94, 310, 311 AF-area mode90, 91</p> <p>3 AF area brackets.....17, 239</p> <p>4 Virtual horizon display 347</p> <p>5 Focus indicator.....30, 101</p>	<p>6 Metering..... 114</p> <p>7 Autoexposure (AE) lock..... 128</p> <p>8 Shutter speed lock icon 126</p> <p>9 Shutter speed..... 119, 121 Autofocus mode87</p> <p>10 Aperture lock icon..... 127</p> <p>11 Aperture (f-number)..... 120, 121 Aperture (number of stops) 120, 424</p>
---	--

12	Exposure mode	116	17	Flash-ready indicator	189
13	Flash compensation indicator	196	18	FV lock indicator	199
14	Exposure compensation indicator.....	131	19	Flash sync indicator.....	329
15	ISO sensitivity	109	20	Aperture stop indicator....	120, 424
	Preset manual white balance recording indicator	160	21	Exposure indicator	122
	ADL bracketing amount	348		Exposure compensation display	131
	AF-area mode	90, 91, 92	22	Low battery warning	19
16	Number of exposures remaining	19, 489	23	Exposure/flash bracketing indicator	134
	Number of shots remaining before memory buffer fills.....	105, 489		WB bracketing indicator	139
	Exposure compensation value	131		ADL bracketing indicator.....	143
	Flash compensation value.....	196	24	Auto ISO sensitivity indicator	112
			25	"k" (appears when memory remains for over 1000 exposures).....	20

Note: Display shown with all indicators lit for illustrative purposes.

No Battery

When the battery is totally exhausted or no battery is inserted, the display in the viewfinder will dim. This is normal and does not indicate a malfunction. The viewfinder display will return to normal when a fully-charged battery is inserted.

The Control Panel and Viewfinder Displays

The brightness of the control panel and viewfinder displays varies with temperature, and the response times of the displays may drop at low temperatures. This is normal and does not indicate a malfunction.

The **info** Button

Press the **info** button to view shooting information during viewfinder photography (📖 201).

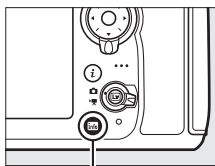

info button



The **i** button

Use the **i** button for quick access to frequently-used settings in playback mode (📖 386) and during viewfinder (📖 205) and live view photography (📖 42) and movie live view (📖 55).

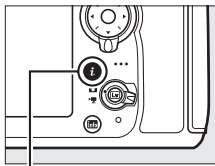

i button



Viewfinder photography



Playback



Live view photography



Movie live view

The BM-12 Monitor Cover

A clear plastic cover is provided with the camera to keep the monitor clean and protect it when the camera is not in use.



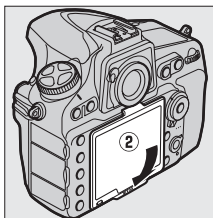
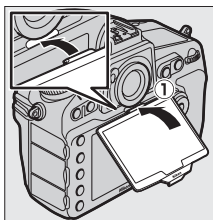

To attach the cover, insert the projection on the top of the cover into the matching indentation above the camera monitor (①) and press the bottom of the cover until it clicks into place (②).

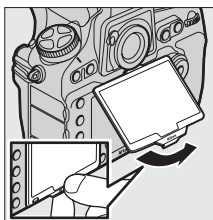



To remove the cover, hold the camera firmly and pull the bottom of the cover gently outwards as shown at right.

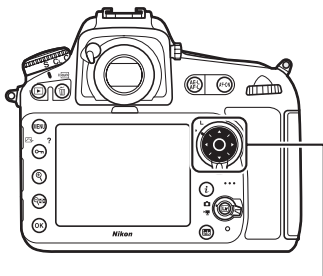

The Multi Selector

In this manual, operations using the multi selector are represented by , , , and  icons.



: Press the multi selector up

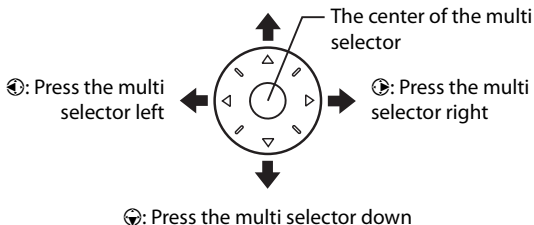

First Steps

Follow the seven steps below to ready the camera for use.

1 Attach the strap.

Attach the strap as shown. Repeat for the second eyelet.

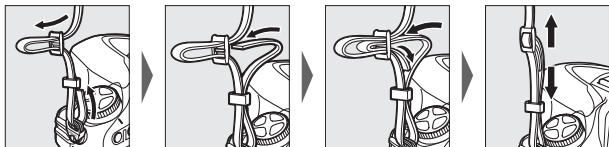

✓ The Battery and Charger

Read and follow the warnings and cautions on pages xiii–xvi and 452–457 of this manual.

2 Charge the battery.

Insert the battery and plug the charger in (depending on the country or region, the charger comes with either an AC wall adapter or a power cable). An exhausted battery will fully charge in about two hours and 35 minutes.

- **AC wall adapter:** Insert the AC wall adapter into the charger AC inlet (1). Slide the AC wall adapter latch as shown (2) and rotate the adapter 90° to fix it in place (3). Insert the battery and plug the charger in.

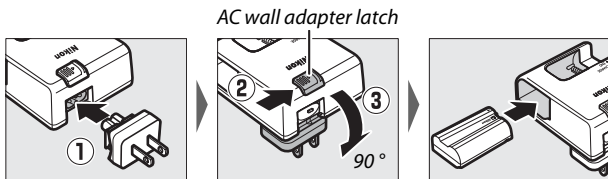

- **Power cable:** After connecting the power cable with the plug in the orientation shown, insert the battery and plug the cable in.

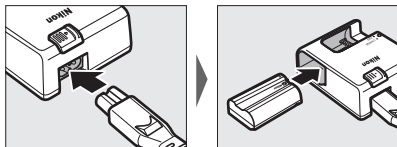

The **CHARGE** lamp will flash while the battery charges.

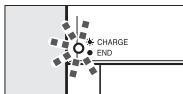

Battery charging

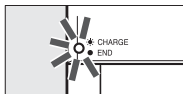

Charging complete

3 Insert the battery and a memory card.

Before inserting or removing the battery or memory cards, confirm that power switch is in the **OFF** position. Insert the battery in the orientation shown, using the battery to keep the orange battery latch pressed to one side. The latch locks the battery in place when the battery is fully inserted.

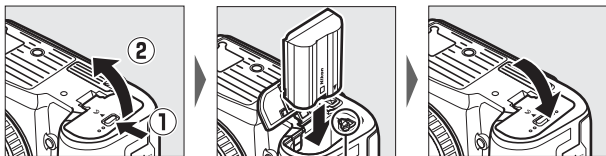

Battery latch

Memory cards are inserted as shown below.

- **SD memory cards:** Slide the card in until it clicks into place.

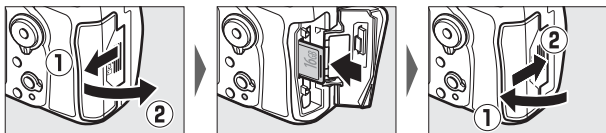

- **CompactFlash memory cards:** Slide the card in, stopping when the eject button pops up.

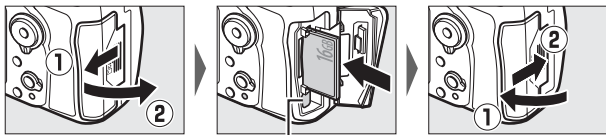

Eject button

4 Attach a lens.

Be careful to prevent dust from entering the camera when the lens or body cap is removed. The lens generally used in this manual for illustrative purposes is an AF-S NIKKOR 24–120mm f/4G ED VR.

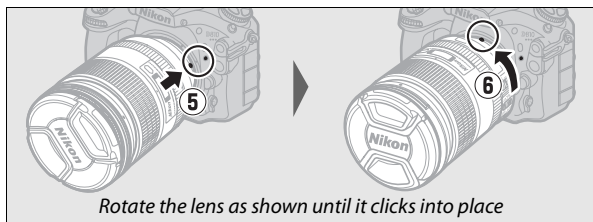
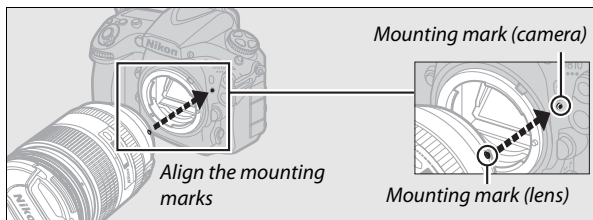
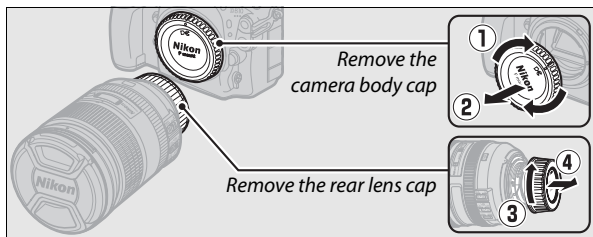

Be sure to remove the lens cap before taking pictures.

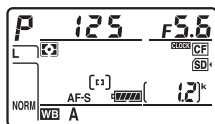
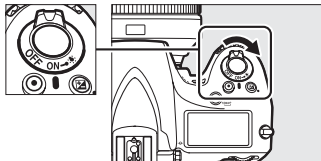

- 5 Turn the camera on.**
Turn the camera on. The control panel will light.

Power switch



Control panel

LCD Illuminators

Rotating the power switch toward  activates the standby timer and control panel backlight (LCD illuminator), allowing the display to be read in the dark. After the power switch is released, the illuminators will remain lit for six seconds while the standby timer is active or until the shutter is released or the power switch is rotated toward  again.



6 Focus the viewfinder.

Lift the diopter adjustment control and rotate it until the viewfinder display, focus points, and AF area brackets are in sharp focus. When operating the control with your eye to the viewfinder, be careful not to put your fingers or fingernails in your eye. Push the diopter adjustment control back in once you have adjusted focus to your satisfaction.

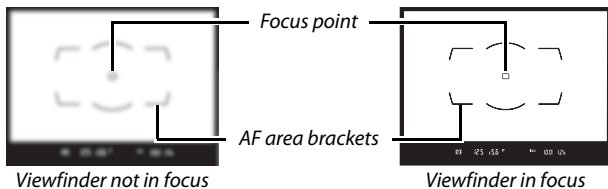
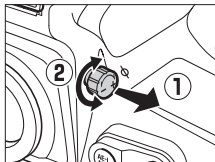

7 Choose a language and set the camera clock.

Use the **Language** and **Time zone and date** options in the setup menu to choose a language and set the camera clock (**Language** is automatically shown highlighted the first time the menus are displayed).

Time zone and date is used to choose a time zone (**Time zone**), choose a date format (**Date format**), turn daylight saving time on and off (**Daylight saving time**), and set the camera clock to the current date and time (**Date and time**; note that the camera uses a 24-hour clock). For information on using the menus, see “Using Camera Menus” (📖 25).

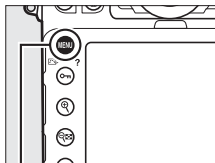

MENU button

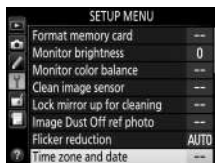

The camera is now ready for use. Proceed to page 29 for information on taking photographs.

■ ■ Battery Level

The battery level is shown in the control panel and viewfinder.

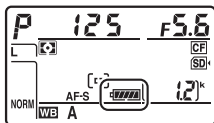

Control panel



Viewfinder

Control panel	Viewfinder	Description
	—	Battery fully charged.
	—	Battery partially discharged.
	—	
		Low battery. Charge battery or ready spare battery.
 (flashes)	 (flashes)	Shutter release disabled. Charge or exchange battery.

■ Number of Exposures Remaining

The memory cards currently inserted in the camera are indicated as shown (the example at right shows the icons displayed when both an SD and a CompactFlash card are inserted). If the memory card is full or an error has occurred, the icon for the affected card will flash (☞ 468).

The control panel and viewfinder show the number of photographs that can be taken at current settings (values over 1000 are rounded down to the nearest hundred; e.g., values between 1200 and 1299 are shown as 1.2 k).

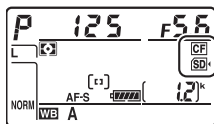

Control panel

Number of exposures remaining

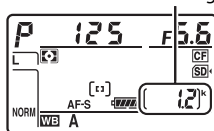

Control panel



Viewfinder

🔍 Camera Off Display

If the camera is turned off with a battery and memory card inserted, the memory card icon and number of exposures remaining will be displayed (some memory cards may in rare cases only display this information when the camera is on).

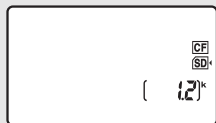

Control panel

■ ■ Removing the Battery and Memory Cards

Removing the Battery

Turn the camera off and open the battery-chamber cover. Press the battery latch in the direction shown by the arrow to release the battery and then remove the battery by hand.

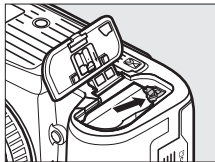

Removing Memory Cards

After confirming that the memory card access lamp is off, turn the camera off and open the memory card slot cover.

- **SD memory cards:** Press the card in and then release it (①). The memory card can then be removed by hand (②).

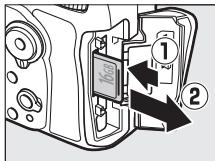

- **CompactFlash memory cards:** Press the eject button (①) to partially eject the card (②). The memory card can then be removed by hand. Do not push on the memory card while pressing the eject button. Failure to observe this precaution could damage the camera or memory card.

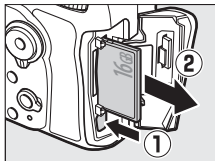

✔ Memory Cards

- Memory cards may be hot after use. Observe due caution when removing memory cards from the camera.
- Turn the power off before inserting or removing memory cards. Do not remove memory cards from the camera, turn the camera off, or remove or disconnect the power source during formatting or while data are being recorded, deleted, or copied to a computer. Failure to observe these precautions could result in loss of data or in damage to the camera or card.
- Do not touch the card terminals with your fingers or metal objects.
- Do not bend, drop, or subject to strong physical shocks.
- Do not apply force to the card casing. Failure to observe this precaution could damage the card.
- Do not expose to water, high levels of humidity, or direct sunlight.
- Do not format memory cards in a computer.

✔ The Write Protect Switch

SD memory cards are equipped with a write protect switch to prevent accidental loss of data.

When this switch is in the “lock”

position, the memory card can not be formatted and photos can not be deleted or recorded (a warning will be displayed in the monitor if you attempt to release the shutter). To unlock the memory card, slide the switch to the “write” position.

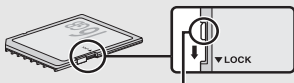

Write-protect switch

✔ No Memory Card

If no memory card is inserted, the control panel and viewfinder will show (-E-). If the camera is turned off with a charged battery and no memory card inserted, (-E-) will be displayed in the control panel.

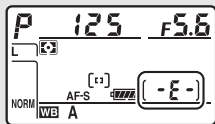

■ Detaching the Lens

Be sure the camera is off when removing or exchanging lenses. To remove the lens, press and hold the lens release button (①) while turning the lens clockwise (②). After removing the lens, replace the lens caps and camera body cap.

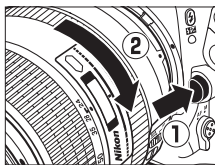

✓ CPU Lenses with Aperture Rings

In the case of CPU lenses equipped with an aperture ring (□ 422), lock aperture at the minimum setting (highest f-number).

✎ Diopter-Adjustment Viewfinder Lenses

Corrective lenses (available separately; □ 438) can be used to further adjust viewfinder diopter. Before attaching a diopter-adjustment viewfinder lens, remove the viewfinder eyepiece by closing the viewfinder shutter to release the eyepiece lock (①) and then unscrewing the eyepiece as shown at right (②).

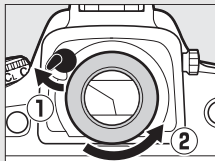

Camera Menu

Most shooting, playback, and setup options can be accessed from the camera menu. To view the menus, press the **MENU** button.

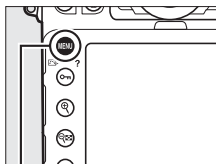

MENU button

Tabs

Choose from the following menus:

- : **Playback** (280)
- : **Shooting** (290)
- : **Custom Settings** (300)
- : **Setup** (365)
- : **Retouch** (384)
- : **MY MENU** or **RECENT SETTINGS** (defaults to **MY MENU**; 414)



Slider shows position in current menu.

Current settings are shown by icons.

Menu options
Options in current menu.

Help icon (25)

Using Camera Menus

■ Menu Controls

The multi selector and **OK** button are used to navigate the menus.

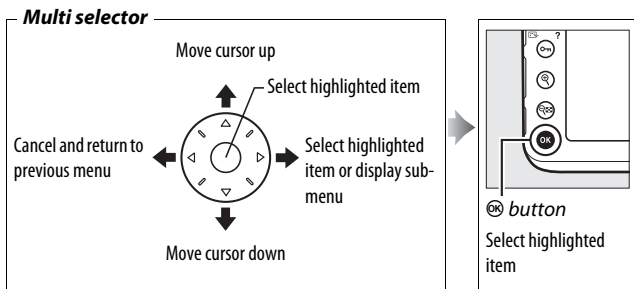

■ The **?** (Help) Icon

If a **?** icon is displayed at the bottom left corner of the monitor, help can be displayed by pressing the **OK** (**?**) button.

A description of the currently selected option or menu will be displayed while the button is pressed. Press **▲** or **▼** to scroll through the display.

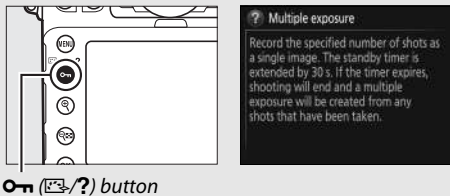

■ Navigating the Menus

Follow the steps below to navigate the menus.

1 Display the menus.

Press the **MENU** button to display the menus.

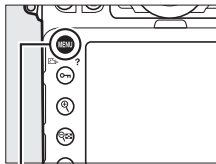

MENU button

2 Highlight the icon for the current menu.

Press  to highlight the icon for the current menu.



3 Select a menu.

Press  or  to select the desired menu.



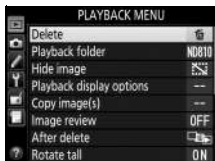

4 Position the cursor in the selected menu.

Press  to position the cursor in the selected menu.



5 Highlight a menu item.

Press  or  to highlight a menu item.

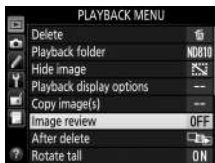



6 Display options.

Press  to display options for the selected menu item.



7 Highlight an option.

Press  or  to highlight an option.



- 8 Select the highlighted item.**
Press **OK** to select the highlighted item. To exit without making a selection, press the **MENU** button.

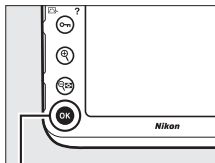

OK button

Note the following points:

- Menu items that are displayed in gray are not currently available.
- While pressing **OK** or the center of the multi selector generally has the same effect as pressing **OK**, there are some cases in which selection can only be made by pressing **OK**.
- To exit the menus and return to shooting mode, press the shutter-release button halfway.

Basic Photography and Playback

“Point-and-Shoot” Photography

1 Ready the Camera.

When framing photographs in the viewfinder, hold the handgrip in your right hand and cradle the camera body or lens with your left.

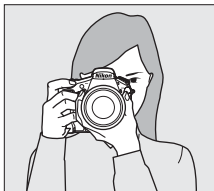

When framing photographs in portrait (tall) orientation, hold the camera as shown at right.



2 Frame the photograph.

At default settings, the camera will focus on the subject in the center focus point. Frame a photograph in the viewfinder with the main subject in the center focus point.

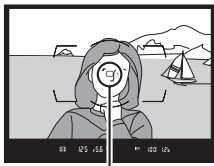

Focus point

3 Press the shutter-release button halfway.

Press the shutter-release button halfway to focus (if the subject is poorly lit, the AF-assist illuminator may light). The in-focus indicator (●) will appear in the viewfinder when the focus operation is complete.



Focus indicator

Viewfinder display	Description
●	Subject in focus.
▶	Focus point is between camera and subject.
◀	Focus point is behind subject.
▶ ◀ (flashes)	Camera unable to focus on subject in focus point using autofocus. See page 99.

4 Shoot.

Smoothly press the shutter-release-button the rest of the way down to take the photograph. The memory card access lamp will light and the photograph will be displayed in the monitor for a few seconds. *Do not eject the memory card or remove or disconnect the power source until the lamp has gone out and recording is complete.*

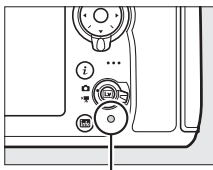

Memory card access lamp

Basic Playback

1 Press the button.



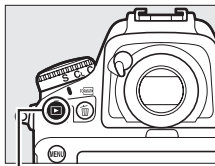

A photograph will be displayed in the monitor. The memory card containing the picture currently displayed is shown by an icon.



 button



2 View additional pictures.

Additional pictures can be displayed by pressing  or . To view additional information on the current photograph, press  and  ( 238).



To end playback and return to shooting mode, press the shutter-release button halfway.

Image Review

When **On** is selected for **Image review** in the playback menu (📖 287), photographs are automatically displayed in the monitor for a few seconds after shooting.

See Also

See page 237 for information on choosing a memory card slot.

Deleting Unwanted Photographs



To delete the photograph currently displayed in the monitor, press the  (FORMAT) button. *Note that photographs can not be recovered once deleted.*

1 Display the photograph.

Display the photograph you wish to delete as described on the preceding page. The location of the current image is shown by an icon at the bottom left corner of the display.



2 Delete the photograph.

Press the  (FORMAT) button. A confirmation dialog will be displayed; press the  (FORMAT) button again to delete the image and return to playback. To exit without deleting the picture, press .

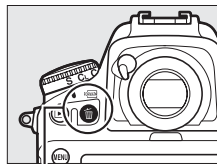

 (FORMAT) button



Delete

To delete multiple images or to select the memory card from which images will be deleted, use the **Delete** option in the playback menu (252).

The Standby Timer (Viewfinder Photography)

The viewfinder indicator display and control panel shutter speed and aperture display will turn off if no operations are performed for about six seconds, reducing the drain on the battery. Press the shutter-release button halfway to reactivate the display. The length of time before the standby timer expires automatically can be selected using Custom Setting c2 (**Standby timer**,  319).

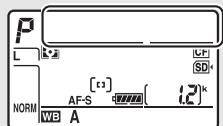

Exposure meters off

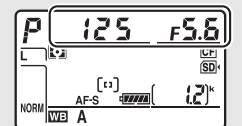

Exposure meters on

Live View Photography

Follow the steps below to take photographs in live view.

- 1 Rotate the live view selector to  (live view photography).**

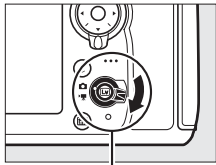

Live view selector

- 2 Press the  button.**
The mirror will be raised and the view through the lens will be displayed in the camera monitor. The subject will no longer be visible in the viewfinder.

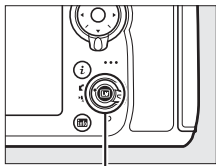

 button

- 3 Position the focus point.**
Position the focus point over your subject as described on page 40.

4 Focus.

Press the shutter-release button halfway to focus.



The focus point will flash green while the camera focuses. If the camera is able to focus, the focus point will be displayed in green; if the camera is unable to focus, the focus point will flash red (note that pictures can be taken even when the focus point flashes red; check focus in the monitor before shooting). Exposure can be locked by pressing the ^{AE-L}_{AF-L} **AE-L/AF-L** button (☞ 128); focus locks while the shutter-release button is pressed halfway.

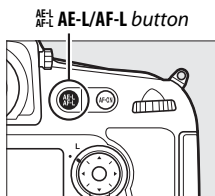

Exposure Preview

During live view photography, you can press  to preview the effects of shutter speed, aperture, and ISO sensitivity on exposure. Exposure can be adjusted by ± 5 EV (☞ 130), although only values between -3 and $+3$ EV are reflected in the preview display. Note that the preview may not accurately reflect the final results when flash lighting is used, Active D-Lighting (☞ 182), High Dynamic Range (HDR; ☞ 184), or bracketing is in effect, **A** (auto) is selected for the Picture Control **Contrast** parameter (☞ 174), or a value other than **0** is selected for **Clarity** (☞ 174), or **x 250** is selected for shutter speed. If the subject is very bright or very dark, the exposure indicators will flash to warn that the preview may not accurately reflect exposure. Exposure preview is not available when **b**, **u**, **i**, **b** or **-** is selected for shutter speed.



✔ Using Autofocus in Live View Photography and Movie Live View

Use an AF-S lens. The desired results may not be achieved with other lenses or teleconverters. Note that in live view, autofocus is slower and the monitor may brighten or darken while the camera focuses. The focus point may sometimes be displayed in green when the camera is unable to focus. The camera may be unable to focus in the following situations:

- The subject contains lines parallel to the long edge of the frame
- The subject lacks contrast
- The subject in the focus point contains areas of sharply contrasting brightness, or includes spot lighting or a neon sign or other light source that changes in brightness
- Flicker or banding appears under fluorescent, mercury-vapor, sodium-vapor, or similar lighting
- A cross (star) filter or other special filter is used
- The subject appears smaller than the focus point
- The subject is dominated by regular geometric patterns (e.g., blinds or a row of windows in a skyscraper)
- The subject is moving

✍ The Standby Timer

Regardless of the setting selected for Custom Setting c2 (**Standby timer**, □ 319), the standby timer will not expire during live view photography.

5 Take the picture.

Press the shutter-release button the rest of the way down to shoot. The monitor will turn off.



6 Exit live view mode.

Press the **Lv** button to exit live view mode.

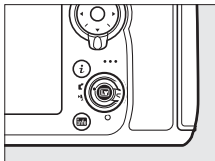

Live View Zoom Preview

Press the **Q** button to magnify the view in the monitor up to a maximum of about 23 \times . A navigation window will appear in a gray frame at the bottom right corner of the display. Use the multi selector to scroll to areas of the frame not visible in the monitor, or press **Q** to zoom out.

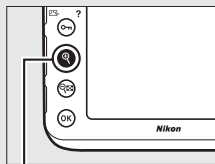

Q button

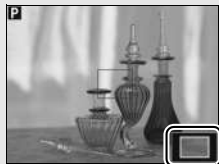

Navigation window

Focus

To focus using autofocus, rotate the focus-mode selector to **AF** and follow the steps below to choose autofocus and AF-area modes. For information on focusing manually, see page 41.

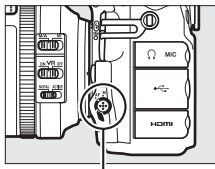

Focus-mode selector

■ ■ Choosing a Focus Mode

The following autofocus modes are available during live view photography and movie live view:

Mode	Description
AF-S	Single-servo AF: For stationary subjects. Focus locks when shutter-release button is pressed halfway.
AF-F	Full-time servo AF: For moving subjects. Camera focuses continuously until shutter-release button is pressed. Focus locks when shutter-release button is pressed halfway.

To choose an autofocus mode, press the AF-mode button and rotate the main command dial until the desired mode is displayed in the monitor.

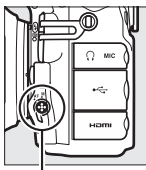

AF-mode button







Main command dial



Monitor

■ ■ Choosing an AF-Area Mode

The following AF-area modes can be selected during live view photography and movie live view:

Mode	Description
	Face-priority AF: Use for portraits. The camera automatically detects and focuses on portrait subjects; the selected subject is indicated by a double yellow border (if multiple faces, up to a maximum of 35, are detected, the camera will focus on the closest subject; to choose a different subject, use the multi selector). If the camera can no longer detect the subject (because, for example, the subject has turned to face away from the camera), the border will no longer be displayed.
	Wide-area AF: Use for hand-held shots of landscapes and other non-portrait subjects. Use the multi selector to move the focus point anywhere in the frame, or press the center of the multi selector to position the focus point in the center of the frame.
	Normal-area AF: Use for pin-point focus on a selected spot in the frame. Use the multi selector to move the focus point anywhere in the frame, or press the center of the multi selector to position the focus point in the center of the frame. A tripod is recommended.
	Subject-tracking AF: Use the multi selector to position the focus point over your subject and press the center of the multi selector to start tracking. The focus point will track the selected subject as it moves through the frame. To end tracking, press the center of the multi selector again. Note that the camera may be unable to track subjects if they move quickly, leave the frame or are obscured by other objects, change visibly in size, color, or brightness, or are too small, too large, too bright, too dark, or similar in color or brightness to the background.

To choose an AF-area mode, press the AF-mode button and rotate the sub-command dial until the desired mode is displayed in the monitor.

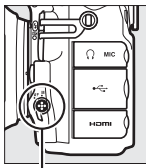

AF-mode button

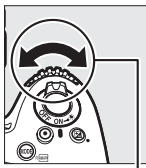

Sub-command dial



Monitor

Manual Focus

To focus in manual focus mode (📖 100), rotate the lens focus ring until the subject is in focus. To magnify the view in the monitor for precise focus, press the  button (📖 38).

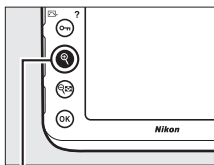



 button

Previewing Focus During Live View Photography

To temporarily select maximum aperture for an improved focus preview during live view photography, press the **Pv** button. To return aperture to its original value, press the button again or focus using autofocus. If the shutter-release button is pressed all the way down to take a picture during focus preview, aperture will return to the original value before the photo is taken.

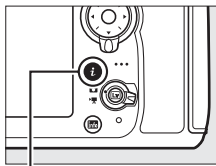

Using the *i* Button

The options listed below can be accessed by pressing the *i* button during live view photography. Highlight items using the multi selector and press  to view options for the highlighted item. After choosing the desired setting, press  to return to the *i*-button menu. Press the *i* button again to exit to the shooting display.





i button











Option	Description
Image area	Choose an image area for live view photography (📖 74).
Active D-Lighting	Adjust Active D-Lighting (📖 182).
Electronic front-curtain shutter	Enable or disable the electronic front-curtain shutter for mirror-up photography (📖 323).
Monitor brightness	Press  or  to adjust monitor brightness for live view photography (note that this affects live view only and has no effect on photographs or movies or on the brightness of the monitor for menus or playback; to adjust the brightness of the monitor for menus and playback without affecting live view photography or movie live view, use the Monitor brightness option in the setup menu as described on page 367).



Option	Description
<p>Photo live view display WB</p>	<p>During live view photography, the white balance (hue) of the monitor can be set to a value different from that used for photographs (☞ 148). This can be effective if the lighting under which shots are framed is different from that used when the photographs are taken, as is sometimes the case when a flash or preset manual white balance is used. Adjusting the photo live view display white balance to produce a similar effect to that used for the actual photographs makes it easier to picture the results. To use the same white balance for both the view in the monitor and the photograph, select None.</p> 
<p>Split-screen display zoom</p>	<p>View two separate areas of the frame side-by-side (☞ 44). This option can be used, for example, to align buildings with the horizon.</p> 

■ Split-Screen Display Zoom

Selecting **Split-screen display zoom** in the live photography **i** button menu splits the display into two boxes showing separate areas of the frame side-by-side at a high zoom ratio. The positions of the magnified areas are shown in the navigation window.

Use the  and  buttons to zoom in and out, or use the  (/?) button to select a box and press  or  to scroll the selected area left or right. Pressing  or  scrolls both areas up or down simultaneously. To focus on the subject at the center of the selected area, press the shutter-release button halfway. To exit the split-screen display, press the **i** button.



Navigation window



Area in focus

The Live View Display: Live View Photography



Item	Description	
① Time remaining	The amount of time remaining before live view ends automatically. Displayed if shooting will end in 30 s or less.	48
② Photo live view display white balance indicator	Monitor hue (photo live view display white balance).	—
③ Autofocus mode	The current autofocus mode.	39
④ AF-area mode	The current AF-area mode.	40
⑤ Focus point	The current focus point. The display varies with the option selected for AF-area mode.	40

The Information Display: Live View Photography

To hide or display indicators in the monitor during live view photography, press the **info** button.

Information on



Information off



Framing guides



Virtual horizon
(379)

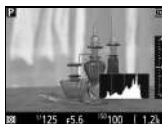

Histogram (exposure preview only; 36)

☑ Shooting in Live View Mode

To prevent light entering via the viewfinder from interfering with photographs or exposure, close the viewfinder eyepiece shutter.

Although they will not appear in the final picture, jagged edges, color fringing, moiré, and bright spots may appear in the monitor, while bright bands may appear in some areas with flashing signs and other intermittent light sources or if the subject is briefly illuminated by a strobe or other bright, momentary light source. In addition, distortion may occur if the camera is panned horizontally or an object moves at high speed through the frame. Flicker and banding visible in the monitor under fluorescent, mercury vapor, or sodium lamps can be reduced using **Flicker reduction** (☐ 371), although they may still be visible in the final photograph at some shutter speeds. When shooting in live view mode, avoid pointing the camera at the sun or other strong light sources. Failure to observe this precaution could result in damage to the camera's internal circuitry.

Movie recording is not available during live view photography and pressing the movie-record button has no effect. Select movie live view (☐ 49) to shoot movies.

✔ The Count Down Display

A count down will be displayed 30 s before live view ends automatically (the timer turns red if live view is about to end to protect the internal circuits or, if an option other than **No limit** is selected for Custom Setting c4—**Monitor off delay > Live view**; □ 320—5 s before the monitor is due to turn off automatically). Depending on shooting conditions, the timer may appear immediately when live view is selected.

🔗 HDMI

If the camera is attached to an HDMI video device during live view photography, the camera monitor will remain on and the video device will display the view through the lens.

🔗 See Also

For information on choosing the role played by the center of the multi selector, and by the movie-record button and command dials, see Custom Settings f2 (**Multi selector center button**, □ 341) and f13 (**Assign movie record button**, □ 355). For information on preventing unintended operation of the  button, see Custom Setting f14 (**Live view button options**, □ 356).

Movie Live View

Movies can be recorded in live view.

- 1 Rotate the live view selector to  (movie live view).

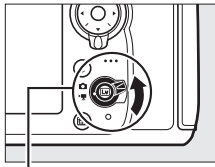

Live view selector

- 2 Press the  button.

The mirror will be raised and the view through the lens will be displayed in the camera monitor as it would appear in the actual movie, modified for the effects of exposure. The subject will no longer be visible in the viewfinder.

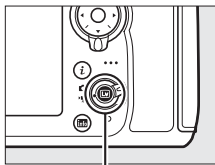

Lv button

The Icon

A  icon (□ 57) indicates that movies can not be recorded.

Audio

The camera can record both video and sound; do not cover the microphone on the front of the camera during movie recording. Note that the built-in microphone may record sounds made by the camera or lens during autofocus, vibration reduction, or changes to aperture.

3 Choose a focus mode (📖 39).



4 Choose an AF-area mode (📖 40).



5 Focus.

Frame the opening shot and press the **AF-ON** button to focus. Note that the number of subjects that can be detected in face-priority AF drops during movie recording.

AF-ON button

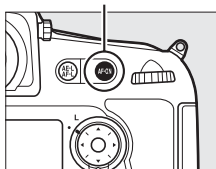



Focusing in Movie Live View

Focus can also be adjusted by pressing the shutter-release button halfway before beginning recording.

Exposure Mode

The following settings can be adjusted in movie live view:

	Aperture	Shutter speed	ISO sensitivity ( 64)	Exposure compensation	Metering
<i>P, S</i>	—	—	—	✓	✓
<i>A</i>	✓	—	—	✓	✓
<i>M</i>	✓	✓	✓	—	✓

In exposure mode *M*, shutter speed can be set to values between $1/25$ s and $1/8000$ s (the slowest available shutter speed varies with the frame rate;  62). In other exposure modes, shutter speed is adjusted automatically. If the subject is over- or under-exposed in mode *P* or *S*, end live view and start movie live view again or select exposure *A* and adjust aperture. Spot metering is not available during movie live view.

White Balance

White balance can be set at any time by pressing the **WB** button and rotating the main command dial ( 149).

6 Start recording.

Press the movie-record button to start recording. A recording indicator and the time available are displayed in the monitor. Exposure can be locked by pressing the AE-L/AF-L button (☞ 128) or altered by up to ± 3 EV using exposure compensation (☞ 130). In autofocus mode, the camera can be refocused by pressing the **AF-ON** button.

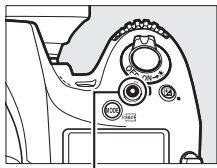

Movie-record button

Recording indicator



Time remaining

7 End recording.

Press the movie-record button again to end recording. Recording will end automatically when the maximum length is reached, or the memory card is full.

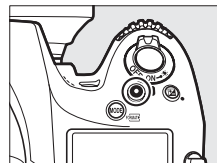

Maximum Length

The maximum length for individual movie files is 4 GB (for maximum recording times, see page 62); note that depending on memory card write speed, shooting may end before this length is reached (☞ 487).

8 Exit movie live view.

Press the  button to exit movie live view.

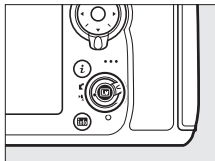

The Count-Down Display

A count down will be displayed 30 s before movie recording ends automatically ( 462). Depending on shooting conditions, the timer may appear immediately when movie recording begins. Note that regardless of the amount of recording time available, live view will still end automatically when the timer expires. Wait for the internal circuits to cool before resuming movie recording.

Indices

If **Index marking** is selected as the “press” option for Custom Setting g1 (**Assign Fn button**; □ 361), g2 (**Assign preview button**; □ 362), or g3 (**Assign AE-L/AF-L button**; □ 363), you can press the selected button during recording to add indices that can be used to locate frames during editing and playback (□ 66). Up to 20 indices can be added to each movie.

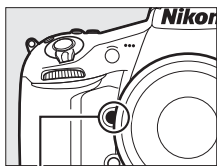

Pv button



Index

See Also

Frame size, frame rate, microphone sensitivity, card slot, and ISO sensitivity options are available in the **Movie settings** menu (□ 62). Focus can be adjusted manually as described on page 41. The roles played by the center of the multi selector, the **Fn**, **Pv**, and **AE-L/AF-L** buttons can be chosen using Custom Settings f2 (**Multi selector center button**; □ 341), g1 (**Assign Fn button**; □ 361), g2 (**Assign preview button**; □ 362), and g3 (**Assign AE-L/AF-L button**, □ 363; this option also allows exposure to be locked without keeping the **AE-L/AF-L** button pressed), respectively. Custom Setting g4 (**Assign shutter button**; □ 364) controls whether the shutter-release button can be used to start movie live view or to start and end movie recording. For information on preventing unintended operation of the **LV** button, see Custom Setting f14 (**Live view button options**; □ 356).

Using the **i** Button

The options listed below can be accessed by pressing the **i** button in movie live view. Highlight items using the multi selector and press **▶** to view options for the highlighted item. After choosing the desired setting, press **OK** to return to the **i**-button menu. Press the **i** button again to exit to the shooting display.

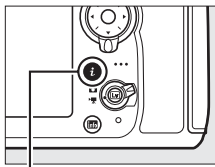









i button



Option	Description
Image area	Choose image area for movie live view (☞ 59).
Frame size/ frame rate	Select a frame size and rate (☞ 62).
Movie quality	Choose movie quality (☞ 62).
Microphone sensitivity	Press ◂ or ▸ to adjust microphone sensitivity (☞ 62). Both the built-in and optional stereo microphones are affected.
Frequency response	Control the frequency response of the built-in microphone or optional stereo microphones (☞ 63).
Wind noise reduction	Enable or disable wind noise reduction using the built-in microphone's low-cut filter (☞ 63).
Destination	When two memory cards are inserted, you can choose the card to which movies are recorded (☞ 63).



Option	Description
<p>Monitor brightness</p>	<p>Press  or  to adjust monitor brightness for movie live view (note that this affects live view only and has no effect on photographs or movies or on the brightness of the monitor for menus or playback;  42).</p> 
<p>Highlight display</p>	<p>Choose whether the brightest areas of the frame (highlights) are shown by slanting lines in the display during movie live view.</p> 
<p>Headphone volume</p>	<p>Press  or  to adjust headphone volume.</p> 

Headphones

Third-party headphones can be used. Note that high sound levels may result in high volume; particular care should be taken when headphones are used.

The Live View Display: Movie Live View

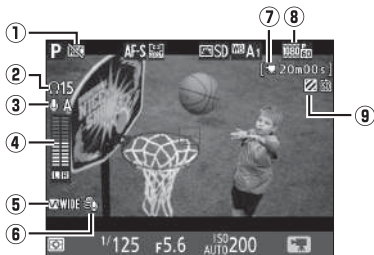

Item	Description	
① "No movie" icon	Indicates that movies can not be recorded.	49
② Headphone volume	Volume of audio output to headphones. Displayed when third-party headphones are connected.	56
③ Microphone sensitivity	Microphone sensitivity.	62
④ Sound level	Sound level for audio recording. Displayed in red if level is too high; adjust microphone sensitivity accordingly.	62
⑤ Frequency response	The current frequency response.	63
⑥ Wind noise reduction	Displayed when wind noise reduction is on.	63
⑦ Time remaining (movie live view)	The recording time available for movies.	52
⑧ Movie frame size	The frame size for movie recording.	62
⑨ Highlight display indicator	Displayed when highlight display is on.	56

The Information Display: Movie Live View

To hide or display indicators in the monitor during movie live view, press the **Info** button.

Information on



Information off



Framing guides



Virtual horizon
(379)



Histogram

Image Area

Regardless of the option selected for **Image area** in the shooting menu (☞ 74), all movies and photographs recorded in movie live view (☞ 49) have an aspect ratio of 16 : 9.

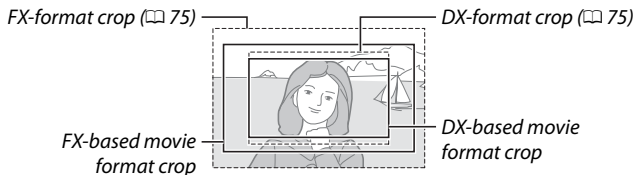

Images recorded with **On** selected for **Image area > Auto DX crop** (☞ 75) and a DX lens attached use a DX-based movie format, as do images recorded with **DX (24×16)** selected for **Image area > Choose image area**. Other images use an FX-based movie format. A  icon is displayed when the DX-based movie format is selected. The approximate size of the area at the center of the image sensor used to record photographs taken in movie live view is 32.8 × 18.4 mm when the FX-based movie format is selected and 23.4 × 13.2 mm when the DX-based movie format is selected.

HDMI

If the camera is connected to an HDMI device (☞ 48), the view through the lens will appear both in the camera monitor and on the HDMI device.

Taking Photos During Movie Live View



If **Take photos** is selected for Custom Setting g4 (**Assign shutter button**,  364), photographs can be taken at any time during movie live view by pressing the shutter-release button all the way down. If movie recording is in progress, recording will end and the footage recorded to that point will be saved. The photograph will be recorded at the current image area setting using a crop with an aspect ratio of 16 : 9. Image quality is determined by the option selected for **Image quality** in the shooting menu ( 79). Note that the exposure for photographs can not be previewed during movie live view; mode **P**, **S**, or **A** is recommended but accurate results can be achieved in mode **M** by adjusting exposure during live view photography ( 35) and then ending live view photography, starting movie live view, and checking the image area.





Image Size

The following table shows the size of photographs taken in movie live view:



Image area	Option	Size (pixels)	Print size (cm/in.)*
FX-based format	Large	6720 × 3776	56.9 × 32.0/22.4 × 12.6
	Medium	5040 × 2832	42.7 × 24.0/16.8 × 9.4
	Small	3360 × 1888	28.4 × 16.0/11.2 × 6.3
DX-based format	Large	4800 × 2704	40.6 × 22.9/16.0 × 9.0
	Medium	3600 × 2024	30.5 × 17.1/12.0 × 6.7
	Small	2400 × 1352	20.3 × 11.4/ 8.0 × 4.5

* Approximate size when printed at 300 dpi. Print size in inches equals image size in pixels divided by printer resolution in **dots per inch (dpi)**; 1 inch = approximately 2.54 cm.

Wireless Remote Controllers and Remote Cords

If **Record movies** is selected for Custom Setting g4 (**Assign shutter button**,  364), the shutter-release buttons on optional wireless remote controllers and remote cords ( 439) can be used to start movie live view and to start and end movie recording.

Recording Movies

Flicker, banding, or distortion may be visible in the monitor and in the final movie under fluorescent, mercury vapor, or sodium lamps or if the camera is panned horizontally or an object moves at high speed through frame (for information on reducing flicker and banding, see **Flicker reduction**,  371). Flicker may also appear while power aperture is in use ( 361). Jagged edges, color fringing, moiré, and bright spots may also appear. Bright bands may appear in some areas of the frame with flashing signs and other intermittent light sources or if the subject is briefly illuminated by a strobe or other bright, momentary light source. When recording movies, avoid pointing the camera at the sun or other strong light sources. Failure to observe this precaution could result in damage to the camera's internal circuitry. Note that noise (randomly-spaced bright pixels, fog, or lines) and unexpected colors may appear if you zoom in on the view through the lens ( 38) during movie live view.

Flash lighting can not be used during movie live view.

Movie Settings

Use the **Movie settings** option in the shooting menu (☰ 290) to adjust the following settings.

- **Frame size/frame rate, Movie quality:** Choose from the following options:

Option *	Maximum bit rate (Mbps) (★ high quality/Normal)	Maximum length (★ high quality/Normal)
$\frac{1080}{60} \text{ PA} / \frac{1080}{60} \text{ P}$ 1920 × 1080; 60p	42/24	10 min./20 min.
$\frac{1080}{50} \text{ PA} / \frac{1080}{50} \text{ P}$ 1920 × 1080; 50p		
$\frac{1080}{30} \text{ PA} / \frac{1080}{30} \text{ P}$ 1920 × 1080; 30p	24/12	20 min./29 min. 59 s
$\frac{1080}{25} \text{ PA} / \frac{1080}{25} \text{ P}$ 1920 × 1080; 25p		
$\frac{1080}{24} \text{ PA} / \frac{1080}{24} \text{ P}$ 1920 × 1080; 24p		
$\frac{720}{60} \text{ PA} / \frac{720}{60} \text{ P}$ 1280 × 720; 60p		
$\frac{720}{50} \text{ PA} / \frac{720}{50} \text{ P}$ 1280 × 720; 50p		

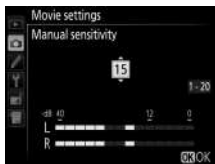

* Actual frame rate is 29.97 fps for values listed as 30p, 23.976 fps for values listed as 24p, and 59.94 fps for values listed as 60p.

- **Microphone sensitivity:** Turn the built-in or optional stereo microphones (☰ 441) on or off or adjust microphone sensitivity. Choose **Auto sensitivity** to adjust sensitivity automatically, **Microphone off** to turn sound recording off; to select microphone sensitivity manually, select **Manual sensitivity**, then highlight an option and press **OK**.



Frame Size and Rate

Frame size and rate affects the distribution and amount of noise (randomly-spaced bright pixels, fog, or bright spots).

- **Frequency response:** If  **Wide range** is selected, the built-in and optional stereo microphones (📖 441) will respond to a wide range of frequencies, from music to the bustling hum of a city street. Choose  **Vocal range** to bring out human voices.
- **Wind noise reduction:** Select **On** to enable the low-cut filter for the built-in microphone (optional stereo microphones are unaffected), reducing noise produced by wind blowing over the microphone (note that other sounds may also be affected). Wind-noise reduction for optional stereo microphones can be enabled or disabled using microphone controls.
- **Destination:** Choose the slot to which movies are recorded. The menu shows the time available on each card; recording ends automatically when no time remains. Note that regardless of the option selected, photographs are recorded to the card in the primary slot (📖 86).

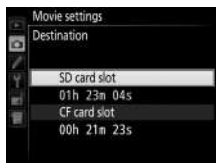

Using an External Microphone

The optional stereo microphone can be used to record sound in stereo or to avoid recording focus noise and other sounds made by the lens (📖 441).

• **Movie ISO sensitivity settings:** Adjust the following ISO sensitivity settings.

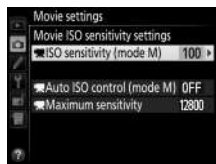

- **ISO sensitivity (mode M):** Choose the ISO sensitivity for exposure mode **M** from values between ISO 64 and Hi 2. Auto ISO sensitivity control is used in other exposure modes.
- **Auto ISO control (mode M):** Select **On** for auto ISO sensitivity control in exposure mode **M**, **Off** to use the value selected for **ISO sensitivity (mode M)**.
- **Maximum sensitivity:** Choose the upper limit for auto ISO sensitivity control from values between ISO 200 and Hi 2. Auto ISO sensitivity control is used in exposure modes **P**, **S**, and **A** and when **On** is selected for **Auto ISO control (mode M)** in exposure mode **M**.



Auto ISO Sensitivity Control





At high ISO sensitivities, the camera may have difficulty focusing and noise (randomly-spaced bright pixels, fog, or lines) may increase. This can be prevented by choosing a lower value for **Movie ISO sensitivity settings** > **Maximum sensitivity**.

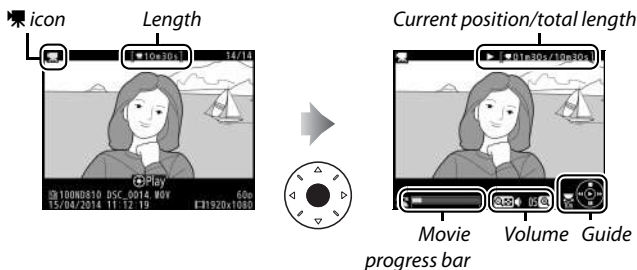







Viewing Movies

Movies are indicated by a  icon in full-frame playback ( 235). Press the center of the multi selector to start playback; your current position is indicated by the movie progress bar.





The following operations can be performed:

To	Use	Description
Pause		Pause playback.
Play		Resume playback when movie is paused or during rewind/advance.
Rewind/ advance		Speed increases with each press, from 2× to 4× to 8× to 16×; keep pressed to skip to beginning or end of movie (first frame is indicated by  in top right corner of monitor, last frame by ). If playback is paused, movie rewinds or advances one frame at a time; keep pressed for continuous rewind or advance.

To	Use	Description
Skip 10 s		Rotate the main command dial one stop to skip ahead or back 10 s.
Skip ahead/back		Rotate the sub-command dial to skip to next or previous index, or to skip to the last or first frame if the movie contains no indices.
Adjust volume		Press  to increase volume,  to decrease.
Trim movie		See page 67 for more information.
Exit		Exit to full-frame playback.
Return to shooting mode		Press the shutter-release button halfway to exit to shooting mode.

The Icon

Movies with indices ( 54) are indicated by a  icon in full-frame playback.





The Icon

 is displayed in full-frame and movie playback if the movie was recorded without sound.



Editing Movies

Trim footage to create edited copies of movies or save selected frames as JPEG stills.

Option	Description
 Choose start/end point	Create a copy from which the opening or closing footage has been removed.
 Save selected frame	Save a selected frame as a JPEG still.

Trimming Movies

To create trimmed copies of movies:

1 Display a movie full frame (📖 235).

2 Pause the movie on the new opening or closing frame.

Play the movie back as described on page 65, pressing the center of the multi selector to start and resume playback and ⏸ to pause and pressing ⏪ or ⏩ or rotating the main or sub-command dial to locate the



Movie progress bar

desired frame. Your approximate position in the movie can be ascertained from the movie progress bar. Pause playback when you reach the new opening or closing frame.

- 3 Select Choose start/end point.**
Press the **i** button, then highlight **Choose start/end point** and press .

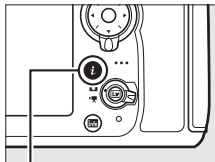

i button

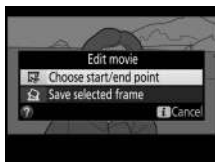

4 Choose the current frame as the new start or end point.

To create a copy that begins from the current frame, highlight **Start point** and press **OK**. The frames before the current frame will be removed when you save the copy.

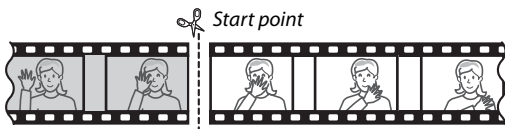
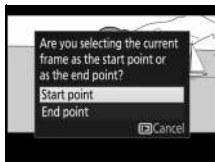

To create a copy that ends at the current frame, highlight **End point** and press **OK**. The frames after the current frame will be removed when you save the copy.

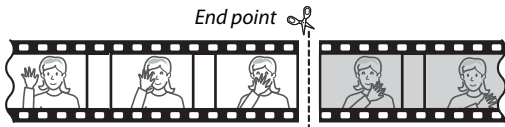

5 Confirm the new start or end point.

If the desired frame is not currently displayed, press ⏩ or ⏪ to advance or rewind (to skip to 10 s ahead or back, rotate the main command dial one stop; to skip to an index, or to the first or last frame if the movie contains no indices, rotate the sub-command dial).



6 Create the copy.

Once the desired frame is displayed, press ⏩.

7 Preview the movie.

To preview the copy, highlight **Preview** and press ⏹ (to interrupt the preview and return to the save options menu, press ⏩). To abandon the current copy and return to Step 5, highlight **Cancel** and press ⏹; to save the copy, proceed to Step 8.



8 Save the copy.

Highlight **Save as new file** and press **OK** to save the copy to a new file. To replace the original movie file with the edited copy, highlight **Overwrite existing file** and press **OK**.



Trimming Movies

Movies must be at least two seconds long. The copy will not be saved if there is insufficient space available on the memory card.

Copies have the same time and date of creation as the original.

Choosing the Role of the Current Frame

To make the frame displayed in Step 5 the new end point (▮) instead of the new start point (▮) or vice versa, press the **OK** (**↔/?**) button.

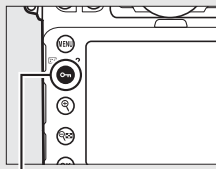

OK (**↔/?**) button



Saving Selected Frames

To save a copy of a selected frame as a JPEG still:

1 Pause the movie on the desired frame.

Play the movie back as described on page 65, pressing the center of the multi selector to start and resume playback and  to pause. Pause the movie at the frame you intend to copy.



2 Choose Save selected frame.

Press the **i** button, then highlight **Save selected frame** and press .

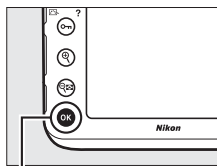

i button



3 Create a still copy.

Press  to create a still copy of the current frame.



4 Save the copy.

Highlight **Yes** and press **Ⓚ** to create a fine-quality (📖 79) JPEG copy of the selected frame.

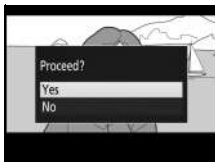

🔍 Save Selected Frame

JPEG movie stills created with the **Save selected frame** option can not be retouched. JPEG movie stills lack some categories of photo information (📖 238).

🔍 The Retouch Menu

Movies can also be edited using the **Edit movie** option in the retouch menu (📖 384).

Image Recording Options



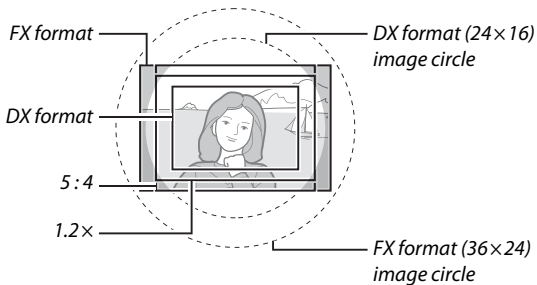

Image Area

Choose from image areas of **FX (36×24) 1.0×** (FX format), **DX (24×16) 1.5×** (DX format), **5 : 4 (30×24)**, and **1.2×** (30×20). See page 490 for information on the number of pictures that can be stored at different image area settings.



■ ■ Image Area Options

The camera offers a choice of the following image areas:

Option	Description
 FX (36×24) 1.0× (FX format)	Images are recorded in FX format using the full area of the image sensor (35.9 × 24.0 mm), producing an angle of view equivalent to a NIKKOR lens on a 35mm format camera.
 1.2× (30×20) 1.2×	A 30.0 × 19.9 mm area at the center of the image sensor is used to record photographs. To calculate the approximate focal length of the lens in 35mm format, multiply by 1.2.
 DX (24×16) 1.5× (DX format)	An area at the center of the image sensor 23.4 × 15.6 mm is used to record pictures in DX format. To calculate the approximate focal length of the lens in 35mm format, multiply by 1.5.
 5 : 4 (30×24)	Pictures are recorded with an aspect ratio of 5 : 4 (30.0 × 24.0 mm).

■ ■ Automatic Crop Selection

To automatically select a DX crop when a DX lens is attached, select **On** for **Image area > Auto DX crop** in the shooting menu (📖 290). The image area selected in the shooting menu or with the camera controls will be used only when a non-DX lens is attached. Select **Off** to use the currently-selected image area with all lenses.

Auto DX Crop

The controls listed on page 78 can not be used to select image area when a DX lens is attached and **Auto DX crop** is on.

Image Area

The selected option is shown in the information display.



DX Lenses

DX lenses are designed for use with DX format cameras and have a smaller angle of view than lenses for 35mm format cameras. If **Auto DX crop** is off and an option other than **DX (24×16)** (DX format) is selected for **Choose image area** when a DX lens is attached, the edges of the image may be eclipsed. This may not be apparent in the viewfinder, but when the images are played back you may notice a drop in resolution or that the edges of the picture are blacked out.

The Viewfinder Display

The 1.2×, DX format, and 5 : 4 crops are shown below; the area outside the crop can be viewed in gray when **Off** is selected for Custom Setting a6 (**AF point illumination**,  310).



1.2×



DX format



5 : 4

See Also

See page 59 for information on the crops available in movie live view.

The image area can be selected using the **Image area > Choose image area** option in the shooting menu or by pressing a control and rotating a command dial.

■ The Image Area Menu

1 Select Image area.

Highlight **Image area** in the shooting menu and press .



2 Select Choose image area.

Highlight **Choose image area** and press .



3 Adjust settings.



Choose an option and press . The selected crop is displayed in the viewfinder ( 76).



Image Size

Image size varies with the option selected for image area.

1 Assign image area selection to a camera control.

Select **Choose image area** as the “press + command dials” option for a camera control in the Custom Settings menu (☞ 300). Image area selection can be assigned to the **Fn** button (Custom Setting f4, **Assign Fn button**, ☞ 343), the **Pv** button (Custom Setting f5, **Assign preview button**, ☞ 349), the **AE-L/AF-L** button (Custom Setting f6, **Assign AE-L/AF-L button**, ☞ 349), or the movie-record button (Custom Setting f13, **Assign movie record button**, ☞ 355).

2 Use the selected control to choose an image area.

The image area can be selected by pressing the selected button and rotating the main or sub-command dial until the desired crop is displayed in the viewfinder (☞ 76).

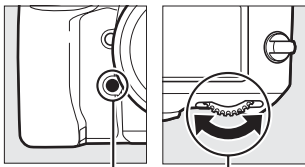

Fn button Main command dial

The option currently selected for image area can be viewed by pressing the button to display the image area in the control panel, viewfinder, or information display. FX format is displayed as “36 – 24”, 1.2× as “30 – 20”, DX format as “24 – 16”, and 5 : 4 as “30 – 24”.

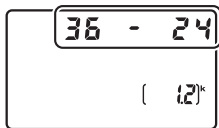

Image Quality

The D810 supports the following image quality options. See page 489 for information on the number of pictures that can be stored at different image quality and size settings.

Option	File type	Description
NEF (RAW)	NEF	RAW data from the image sensor are saved without additional processing. Settings such as white balance and contrast can be adjusted after shooting.
TIFF (RGB)	TIFF (RGB)	Record uncompressed TIFF-RGB images at a bit depth of 8 bits per channel (24-bit color). TIFF is supported by a wide variety of imaging applications.
JPEG fine	JPEG	Record JPEG images at a compression ratio of roughly 1:4 (fine quality).*
JPEG normal		Record JPEG images at a compression ratio of roughly 1:8 (normal quality).*
JPEG basic		Record JPEG images at a compression ratio of roughly 1:16 (basic quality).*
NEF (RAW)+ JPEG fine	NEF/JPEG	Two images are recorded, one NEF (RAW) image and one fine-quality JPEG image.
NEF (RAW)+ JPEG normal		Two images are recorded, one NEF (RAW) image and one normal-quality JPEG image.
NEF (RAW)+ JPEG basic		Two images are recorded, one NEF (RAW) image and one basic-quality JPEG image.

* **Size priority** selected for **JPEG/TIFF recording** > **JPEG compression**. The compression ratio is an approximation only; the actual ratio varies with ISO sensitivity and the scene recorded.

Image quality is set by pressing the **QUAL** button and rotating the main command dial until the desired setting is displayed in the control panel.

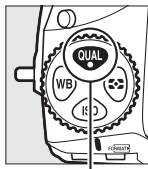

QUAL button

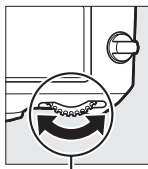

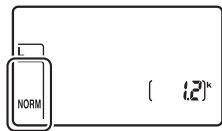

Main command dial



Control panel

NEF (RAW) Images

NEF (RAW) images can be viewed on the camera or using software such as ViewNX 2 or Capture NX-D (ViewNX 2 can be installed from the supplied installer CD, while Capture NX-D can be downloaded from a link in the ViewNX 2 installer;  253). JPEG copies of NEF (RAW) images can be created using the **NEF (RAW) processing** option in the retouch menu ( 399).

NEF+JPEG



When photographs taken at settings of NEF (RAW) + JPEG are viewed on the camera with only one memory card inserted, only the JPEG image will be displayed. If both copies are recorded to the same memory card, both copies will be erased when the photo is deleted. If the JPEG copy is recorded to a separate memory card using the **Secondary slot function > RAW primary - JPEG secondary** option, deleting the JPEG copy will not delete the NEF (RAW) image.

The Image Quality Menu

Image quality can also be adjusted using the **Image quality** option in the shooting menu ( 290).



■ ■ JPEG Compression

To choose the type of compression for JPEG images, highlight **JPEG/TIFF recording** > **JPEG compression** in the shooting menu and press .

Option	Description
 Size priority	Images are compressed to produce relatively uniform file size.
 Optimal quality	Optimal image quality. File size varies with scene recorded.

■ ■ NEF (RAW) Compression

To choose the type of compression for NEF (RAW) images, highlight **NEF (RAW) recording** > **NEF (RAW) compression** in the shooting menu and press .

Option	Description
ON  Lossless compressed	NEF images are compressed using a reversible algorithm, reducing file size by about 20–40% with no effect on image quality.
ON  Compressed	NEF images are compressed using a non-reversible algorithm, reducing file size by about 35–55% with almost no effect on image quality.
Uncompressed	NEF images are not compressed.

■ ■ NEF (RAW) Bit Depth

To choose a bit depth for NEF (RAW) images, highlight **NEF (RAW) recording** > **NEF (RAW) bit depth** in the shooting menu and press .

Option	Description
12-bit 12-bit	NEF (RAW) images are recorded at a bit depth of 12 bits.
14-bit 14-bit	NEF (RAW) images are recorded at a bit depth of 14 bits, producing files larger than those with a bit depth of 12 bits but increasing the color data recorded.

See Also

See page 83 for the image size options available for JPEG and TIFF images, page 85 for the image size options available for NEF (RAW) images.

Image Size

Image size is measured in pixels. In the case of JPEG and TIFF images, you can choose from **Large**, **Medium**, or **Small** (note that image size varies depending on the option selected for **Image area**,  74):

Image area	Option	Size (pixels)	Print size (cm/in.)*
FX (36×24) (FX format)	Large	7360 × 4912	62.3 × 41.6/24.5 × 16.4
	Medium	5520 × 3680	46.7 × 31.2/18.4 × 12.3
	Small	3680 × 2456	31.2 × 20.8/12.3 × 8.2
1.2× (30×20)	Large	6144 × 4080	52.0 × 34.5/20.5 × 13.6
	Medium	4608 × 3056	39.0 × 25.9/15.4 × 10.2
	Small	3072 × 2040	26.0 × 17.3/10.2 × 6.8
DX (24×16) (DX format)	Large	4800 × 3200	40.6 × 27.1/16.0 × 10.7
	Medium	3600 × 2400	30.5 × 20.3/12.0 × 8.0
	Small	2400 × 1600	20.3 × 13.5/ 8.0 × 5.3
5 : 4 (30×24)	Large	6144 × 4912	52.0 × 41.6/20.5 × 16.4
	Medium	4608 × 3680	39.0 × 31.2/15.4 × 12.3
	Small	3072 × 2456	26.0 × 20.8/10.2 × 8.2

* Approximate size when printed at 300 dpi. Print size in inches equals image size in pixels divided by printer resolution in **dots per inch** (dpi; 1 inch = approximately 2.54 cm).

Image size for JPEG and TIFF images can be set by pressing the **QUAL** button and rotating the sub-command dial until the desired option is displayed in the control panel.

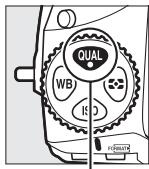

QUAL button

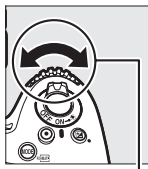

Sub-command dial



Control panel

The Image Size Menu

Image size for JPEG and TIFF images can also be adjusted using the **JPEG/TIFF recording > Image size** option in the shooting menu (☞ 290).

■ ■ NEF (RAW) Images

When recording photographs in NEF (RAW) format, you can choose from sizes of **RAW L Large** and **RAW S Small** using the **NEF (RAW) recording > Image size** option in the shooting menu. Small-size images are about half the size of their large-size counterparts. An asterisk (*) appears in the control panel when **RAW S Small** is selected.

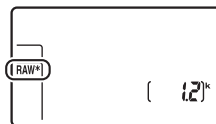
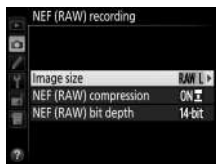

Control panel

✓ NEF (RAW) Images

Image size for NEF (RAW) photographs can not be selected using the **QUAL** button and command dials. Small-size NEF (RAW) images are recorded in uncompressed 12-bit format, regardless of the options selected for **NEF (RAW) compression** and **NEF (RAW) bit depth** in the **NEF (RAW) recording** menu, and can not be retouched (📖 384).

Using Two Memory Cards

When two memory cards are inserted in the camera, you can choose one as the primary card using the **Primary slot selection** item in the shooting menu. Select **SD card slot** to designate the card in the SD card slot as the primary card, **CF card slot** to choose the CompactFlash card. The roles played by the primary and secondary cards can be chosen using the **Secondary slot function** option in the shooting menu. Choose from **Overflow** (the secondary card is used only when the primary card is full), **Backup** (each picture is recorded to both the primary and secondary card), and **RAW primary - JPEG secondary** (as for **Backup**, except that the NEF/RAW copies of photos recorded at settings of NEF/RAW + JPEG are recorded only to the primary card and the JPEG copies only to the secondary card).

"Backup" and "RAW Primary - JPEG Secondary"

The camera shows the number of exposures remaining on the card with the least amount of memory. Shutter release will be disabled when either card is full.

Recording Movies

When two memory cards are inserted in the camera, the slot used to record movies can be selected using the **Movie settings > Destination** option in the shooting menu (☞ 63).

Focus

This section describes the focus options available when photographs are framed in the viewfinder. Focus can be adjusted automatically (see below) or manually (□ 100). The user can also select the focus point for automatic or manual focus (□ 94) or use focus lock to focus to recompose photographs after focusing (□ 96).

Autofocus

To use autofocus, rotate the focus-mode selector to **AF**.

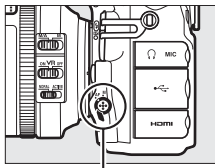

Focus-mode selector

Autofocus Mode

The following autofocus modes can be selected during viewfinder photography:

Mode	Description
AF-S	Single-servo AF: For stationary subjects. Focus locks when shutter-release button is pressed halfway. At default settings, shutter can only be released when in-focus indicator (●) is displayed (<i>focus priority</i> ; □ 307).
AF-C	Continuous-servo AF: For moving subjects. Camera focuses continuously while shutter-release button is pressed halfway; if subject moves, camera will engage <i>predictive focus tracking</i> (□ 88) to predict final distance to subject and adjust focus as necessary. At default settings, shutter can be released whether or not subject is in focus (<i>release priority</i> ; □ 306).

Autofocus mode can be selected by pressing the AF-mode button and rotating the main command dial until the desired setting is displayed in the viewfinder and control panel.

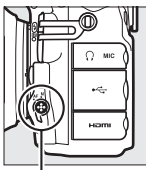

AF-mode button

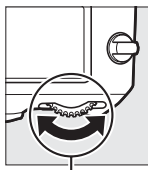

Main command dial

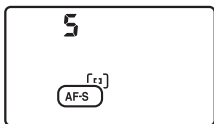

Control panel



Viewfinder

The AF-ON Button

For the purpose of focusing the camera, pressing the **AF-ON** button has the same effect as pressing the shutter-release button halfway.

AF-ON button

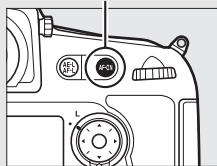

Predictive Focus Tracking

In **AF-C** mode, the camera will initiate predictive focus tracking if the subject moves toward or away from the camera while the shutter-release button is pressed halfway or the **AF-ON** button is pressed. This allows the camera to track focus while attempting to predict where the subject will be when the shutter is released.

🔍 See Also

For information on using focus priority in continuous-servo AF, see Custom Setting a1 (**AF-C priority selection**, □ 306). For information on using release priority in single-servo AF, see Custom Setting a2 (**AF-S priority selection**, □ 307). For information on preventing the camera from focusing when the shutter-release button is pressed halfway, see Custom Setting a4 (**AF activation**, □ 308). See Custom Setting a12 (**Autofocus mode restrictions**, □ 314) for information on limiting focus-mode selection to **AF-S** or **AF-C** and f9 (**Customize command dials**) > **Change main/sub** (□ 351) for information on using the sub-command dial to choose the focus mode. See page 39 for information on the autofocus options available in live view or during movie recording.

AF-Area Mode

Choose how the focus point is selected during viewfinder photography.

- **Single-point AF:** Select the focus point as described on page 94; the camera will focus on the subject in the selected focus point only. Use with stationary subjects.
- **Dynamic-area AF:** Select the focus point as described on page 94. In **AF-C** focus mode, the camera will focus based on information from surrounding focus points if the subject briefly leaves the selected point. The number of focus points varies with the mode selected:
 - **9-point dynamic-area AF:** Choose when there is time to compose the photograph or when photographing subjects that are moving predictably (e.g., runners or race cars on a track).
 - **21-point dynamic-area AF:** Choose when photographing subjects that are moving unpredictably (e.g., players at a football game).
 - **51-point dynamic-area AF:** Choose when photographing subjects that are moving quickly and can not be easily framed in the viewfinder (e.g., birds).
- **3D-tracking:** Select the focus point as described on page 94. In **AF-C** focus mode, the camera will track subjects that leave the selected focus point and select new focus points as required. Use to quickly compose pictures with subjects that are moving erratically from side to side (e.g., tennis players). If the subject leaves viewfinder, remove your finger from the shutter-release button and recompose the photograph with the subject in the selected focus point.



- **Group-area AF:** The camera focuses using a group of focus points selected by the user, reducing the risk of the camera focusing on the background instead of on the main subject. Choose for subjects that are difficult to photograph using a single focus point. If faces are detected in **AF-S** focus mode, the camera will give priority to portrait subjects.
- **Auto-area AF:** The camera automatically detects the subject and selects the focus point; if a face is detected, the camera will give priority to the portrait subject. The active focus points are highlighted briefly after the camera focuses; in **AF-C** mode, the main focus point remains highlighted after the other focus points have turned off.



AF-area mode can be selected by pressing the AF-mode button and rotating the sub-command dial until the desired setting is displayed in the viewfinder and control panel.

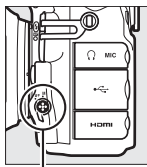

AF-mode button

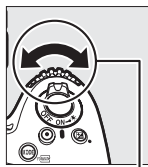

Sub-command dial

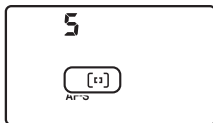

Control panel



Viewfinder

3D-tracking

When the shutter-release button is pressed halfway, the colors in the area surrounding the focus point are stored in the camera. Consequently 3D-tracking may not produce the desired results with subjects that are similar in color to the background or that occupy a very small area of the frame.

AF-Area Mode

AF-area mode is shown in the control panel and viewfinder.





AF-area mode	Control panel	Viewfinder
Single-point AF	S	S
9-point dynamic-area AF*	d 9	d 9
21-point dynamic-area AF*	d21	d21
51-point dynamic-area AF*	d51	d51
3D-tracking	3d	3d
Group-area AF	GrP	GrP
Auto-area AF	Auto	Auto

* Only active focus point is displayed in the viewfinder. Remaining focus points provide information to assist focus operation.

Manual Focus

Single-point AF is automatically selected when manual focus is used.

See Also

For information on adjusting how long the camera waits before refocusing when an object moves in front of the camera, see Custom Setting a3 (**Focus tracking with lock-on**,  308). See Custom Setting a5 (**Focus point illumination**,  309) for information on choosing how the focus point is displayed in dynamic-area and group-area AF, a11 (**Limit AF-area mode selection**,  314) for information on limiting AF-area mode selection, and f9 (**Customize command dials**) > **Change main/sub** ( 351) for information on using the main command dial to choose the AF-area mode. See page 40 for information on the autofocus options available in live view or during movie recording.

Focus Point Selection

The camera offers a choice of 51 focus points that can be used to compose photographs with the main subject positioned almost anywhere in the frame. Follow the steps below to choose the focus point (in group-area AF, you can follow these steps to choose a group of focus points).

- 1 Rotate the focus selector lock to ●.**
This allows the multi selector to be used to select the focus point.

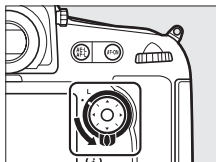

Focus selector lock

- 2 Select the focus point.**
Use the multi selector to select the focus point in the viewfinder while the exposure meters are on. The center focus point can be selected by pressing the center of the multi selector.



The focus selector lock can be rotated to the locked (L) position following selection to prevent the selected focus point from changing when the multi selector is pressed.

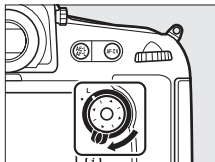

🔍 Auto-area AF

The focus point for auto-area AF is selected automatically; manual focus-point selection is not available.

🔍 See Also

For information on choosing when and how the focus point is illuminated, see Custom Setting a5 (**Focus point illumination**, □ 309) and a6 (**AF point illumination**, □ 310). For information on setting focus-point selection to “wrap around,” see Custom Setting a7 (**Focus point wrap-around**, □ 310). For information on choosing the number of focus points that can be selected using the multi selector, see Custom Setting a8 (**Number of focus points**, □ 311). For information on choosing separate focus points and/or AF-area modes for vertical and horizontal orientations, see Custom Setting a9 (**Store by orientation**, □ 312). For information on changing the role of the multi selector center button, see Custom Setting f2 (**Multi selector center button**, □ 341).

Focus Lock

Focus lock can be used to change the composition after focusing, making it possible to focus on a subject that will not be in a focus point in the final composition. If the camera is unable to focus using autofocus (☞ 87), focus lock can also be used to recompose the photograph after focusing on another object at the same distance as your original subject. Focus lock is most effective when an option other than auto-area AF is selected for AF-area mode (☞ 90).

1 Focus.

Position the subject in the selected focus point and press the shutter-release button halfway to initiate focus. Check that the in-focus indicator (●) appears in the viewfinder.



2 Lock focus.

AF-C focus mode (☞ 87): With the shutter-release button pressed halfway (①), press the ^{AE-L}/_{AF-L} **AE-L/AF-L** button (②) to lock both focus and exposure (an **AE-L** icon will be displayed in the viewfinder). Focus will remain locked while the ^{AE-L}/_{AF-L} **AE-L/AF-L** button is pressed, even if you later remove your finger from the shutter-release button.

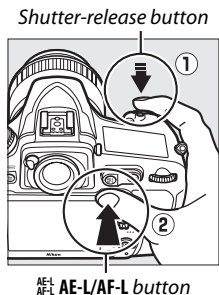

AF-S focus mode: Focus locks automatically when the in-focus indicator (●) appears, and remain locked until you remove your finger from the shutter-release button. Focus can also be locked by pressing the ^{AE-L}/_{AF-L} **AE-L/AF-L** button (see above).



3 Recompose the photograph and shoot.

Focus will remain locked between shots if you keep the shutter-release button pressed halfway (**AF-S**) or keep the ^{AE-L}/_{AF-L} **AE-L/AF-L**



button pressed, allowing several photographs in succession to be taken at the same focus setting.

Do not change the distance between the camera and the subject while focus lock is in effect. If the subject moves, focus again at the new distance.

Locking Focus with the AF-ON Button

During viewfinder photography, focus can be locked using the **AF-ON** button in place of the shutter-release button (□ 88). If **AF-ON only** is selected for Custom Setting a4 (**AF activation**, □ 308), the camera will not focus when the shutter-release button is pressed halfway; instead, the camera will focus when the **AF-ON** button is pressed, at which point focus will lock and remain locked until the **AF-ON** button is pressed again. The shutter can be released at any time, although the in-focus indicator (●) will not be displayed in the viewfinder. Note, however, that if **Focus** is selected for Custom Setting a2 (**AF-S priority selection**, □ 307) and single-point AF is selected for AF-area mode, the shutter will not be released if the camera is unable to focus in single-servo autofocus mode.

See Also

See Custom Setting c1 (**Shutter-release button AE-L**, □ 319) for information on using the shutter-release button to lock exposure, Custom Setting f6 (**Assign AE-L/AF-L button**, □ 349) for information on choosing the role played by ^{AE-L}_{AF-L} AE-L/AF-L button.

Getting Good Results with Autofocus

Autofocus does not perform well under the conditions listed below. The shutter release may be disabled if the camera is unable to focus under these conditions, or the in-focus indicator (●) may be displayed and the camera may sound a beep, allowing the shutter to be released even when the subject is not in focus. In these cases, use manual focus (100) or use focus lock (96) to focus on another subject at the same distance and then recompose the photograph.



There is little or no contrast between the subject and the background.

Example: Subject is the same color as the background.



The focus point contains objects at different distances from the camera.

Example: Subject is inside a cage.



The subject is dominated by regular geometric patterns.

Example: Blinds or a row of windows in a skyscraper.

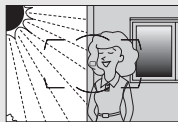

The focus point contains areas of sharply contrasting brightness.

Example: Subject is half in the shade.



Background objects appear larger than the subject.

Example: A building is in the frame behind the subject.

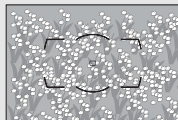

The subject contains many fine details.

Example: A field of flowers or other subjects that are small or lack variation in brightness.

Manual Focus

Manual focus is available for lenses that do not support autofocus (non-AF NIKKOR lenses) or when the autofocus does not produce the desired results (99).

- **AF lenses:** Set the lens focus mode switch (if present) and camera focus-mode selector to **M**.

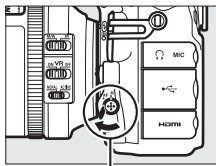

Focus-mode selector

AF Lenses

Do not use AF lenses with the lens focus mode switch set to **M** and the camera focus-mode selector set to **AF**. Failure to observe this precaution could damage the camera or lens. This does not apply to AF-S lenses, which can be used in **M** mode without setting the camera focus-mode selector to **M**.

- **Manual focus lenses:** Set the camera focus-mode selector to **M**.

To focus manually, adjust the lens focus ring until the image displayed on the clear matte field in the viewfinder is in focus. Photographs can be taken at any time, even when the image is not in focus.



■ The Electronic Rangefinder

The viewfinder focus indicator can be used to confirm whether the subject in the selected focus point is in focus (the focus point can be selected from any of the 51 focus points). After positioning the subject in the selected focus point, press the shutter-release button halfway and rotate the lens focus ring until the in-focus indicator (●) is displayed. Note that with the subjects listed on page 99, the in-focus indicator may sometimes be displayed when the subject is not in focus; confirm focus in the viewfinder before shooting. For information on using the electronic rangefinder with optional AF-S/AF-I teleconverters, see page 423.



▣ Focal Plane Position

To determine the distance between your subject and the camera, measure from the focal plane mark (⇄) on the camera body (📖 1). The distance between the lens mounting flange and the focal plane is 46.5 mm (1.83 in.).

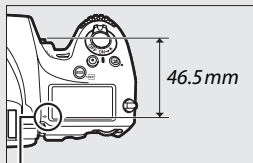

Focal plane mark

Release Mode

Choosing a Release Mode

To choose a release mode, press the release mode dial lock release and turn the release mode dial to the desired setting.

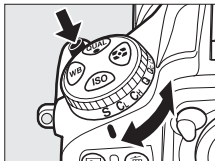

Mode	Description
S	Single frame: Camera takes one photograph each time shutter-release button is pressed.
CL	Continuous low speed: While shutter-release button is held down, camera takes photographs at frame rate selected for Custom Setting d2 (CL mode shooting speed , □ 321). Lower built-in flash (□ 190); continuous release is not available while flash is raised.
CH	Continuous high speed: While shutter-release button is held down, camera takes photographs at frame rate given on page 104. Use for active subjects. Lower built-in flash (□ 190); continuous release is not available while flash is raised.
Q	Quiet shutter-release: As for single frame, except that mirror does not click back into place while shutter-release button is fully pressed, allowing user to control timing of click made by mirror, which is also quieter than in single frame mode. In addition, beep does not sound regardless of setting selected for Custom Setting d1 (Beep ; □ 321).
Qc	Qc (quiet continuous) shutter-release: While shutter-release button is held down, camera takes photographs at frame rate given on page 104. Camera noise is reduced. Lower built-in flash (□ 190); continuous release is not available while flash is raised.

Mode	Description
🕒	Self-timer: Take pictures with the self-timer (📖 106).
MUP	Mirror up: Choose this mode to minimize camera shake in telephoto or close-up photography or in other situations in which the slightest camera movement can result in blurred photographs (📖 108).

Power Source and Frame Rate

The maximum frame advance rate varies with the power source and image area. The figures below are the average maximum frame rates available with continuous-servo AF, manual or shutter-priority auto exposure, a shutter speed of $\frac{1}{250}$ s or faster, settings other than Custom Setting d2 at default values, and memory remaining in the memory buffer.

Power source	Image area	Maximum frame rate (fps) ¹	
		C _H	C _L
Camera with EN-EL15	FX, 5 : 4	5	1–6
	1.2×, DX	6	
Camera with EP-5B power connector and EH-5b AC adapter	FX, 5 : 4	5	
	1.2×	6	
	DX	7	
Camera with MB-D12 (EN-EL15)	FX, 5 : 4	5	
	1.2×, DX	6	
Camera with MB-D12 (EN-EL18)	FX, 5 : 4	5	
	1.2×	6	
	DX	7	
Camera with MB-D12 (AA ²)	FX, 5 : 4	5	
	1.2×	6	
	DX	7	

1 Maximum frame rate when **FX (36 × 24)** or **5 : 4 (30 × 24)** is selected for image area is 5 fps even if higher values are selected for Custom Setting d2 (**CL mode shooting speed**, □ 321).

2 AA-size batteries. Frame rates may drop at low temperatures or when batteries are low.

The stated rates may not be available under some conditions. Frame rate drops at slow shutter speeds or very small apertures (high f-numbers) or when vibration reduction (available with VR lenses) or auto ISO sensitivity control is on (□ 111) or the battery is low. In **Qc** mode, frame rate is fixed at about 3 fps.

The Memory Buffer

The camera is equipped with a memory buffer for temporary storage, allowing shooting to continue while photographs are being saved to the memory card. Up to 100 photographs can be taken in succession; note, however, that frame rate will drop when the buffer is full (r00).

The approximate number of images that can be stored in the memory buffer at current settings is shown in the exposure-count displays in the viewfinder and control panel while the shutter-release button is pressed halfway. The illustration at right shows the display when space remains in the buffer for about 58 pictures.

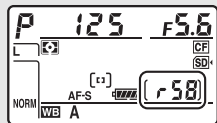

While photographs are being recorded to the memory card, the memory card access lamp will light. Depending on shooting conditions and memory card performance, recording may take from a few seconds to a few minutes. *Do not remove the memory card or remove or disconnect the power source until the access lamp has gone out.* If the camera is switched off while data remain in the buffer, the power will not turn off until all images in the buffer have been recorded. If the battery is exhausted while images remain in the buffer, the shutter release will be disabled and the images transferred to the memory card.

See Also

For information on choosing the maximum number of photographs that can be taken in a single burst, see Custom Setting d3 (**Max. continuous release**,  322). For information on the number of pictures that can be taken in a single burst, see page 489.

Self-Timer Mode (⌚)

The self-timer can be used to reduce camera shake or for self-portraits.

1 Mount the camera on a tripod.

Mount the camera on a tripod or place the camera on a stable, level surface.

2 Select self-timer mode.

Press the release mode dial lock release and turn the release mode dial to ⌚.



Release mode dial

3 Frame the photograph and focus.

In single-servo AF (87), photographs can only be taken if the in-focus (●) indicator appears in the viewfinder.



Close the Viewfinder Eyepiece Shutter

When taking photos without your eye to the viewfinder, close the viewfinder eyepiece shutter to prevent light entering via the viewfinder from appearing in photographs or interfering with exposure.

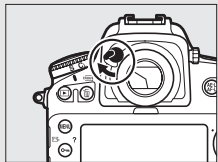

4 Start the timer.

Press the shutter-release button all the way down to start the timer. The self-timer lamp will start



to flash. Two seconds before the photograph is taken, the self-timer lamp will stop flashing. The shutter will be released about ten seconds after the timer starts.

To turn the self-timer off before a photograph is taken, turn the release mode dial to another setting.

Using the Built-in Flash

Before taking a photograph with the flash, press the flash pop-up button to raise the flash and wait for the  indicator to be displayed in the viewfinder (□ 189). Shooting will be interrupted if the flash is raised after the self-timer has started. Note that only one photograph will be taken when the flash fires, regardless of the number of exposures selected for Custom Setting c3 (**Self-timer**; □ 319).

See Also

For information on choosing the duration of the self-timer, the number of shots taken, and the interval between shots, see Custom Setting c3 (**Self-timer**, □ 319). For information on controlling the beeps that sound when the self-timer is used, see Custom Setting d1 (**Beep**, □ 321).

Mirror up Mode (MUP)

Choose this mode to minimize blurring caused by camera movement when the mirror is raised. To use mirror-up mode, press the release mode dial lock release and rotate the release mode dial to **MUP** (mirror up). After

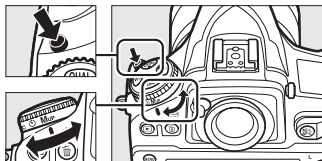

Release mode dial

pressing the shutter-release button halfway to set focus and exposure, press the shutter-release button the rest of the way down to raise the mirror and then press the shutter-release button all the way down again to take the picture. A beep will sound, unless **Off** is selected for Custom Setting d1 (**Beep**, □ 321). The mirror lowers when shooting ends.

✓ Mirror Up

While the mirror is raised, photos can not be framed in the viewfinder and autofocus and metering will not be performed.

✎ Mirror up Mode

A picture will be taken automatically if no operations are performed for about 30 s with the mirror raised.

✎ Preventing Blur

To prevent blurring caused by camera movement, press the shutter-release button smoothly. Use of a tripod is recommended.

✎ See Also

For information on using the electronic front-curtain shutter to further reduce blur, see Custom Setting d5 (**Electronic front-curtain shutter**, □ 323).

ISO Sensitivity

Manual Adjustment

The camera's sensitivity to light can be adjusted according to the amount of light available. Choose from settings that range from ISO 64 to ISO 12800 in steps equivalent to $\frac{1}{3}$ EV. Settings of from about 0.3 to 1 EV below ISO 64 and 0.3 to 2 EV above ISO 12800 are also available for special situations. The higher the ISO sensitivity, the less light needed to make an exposure, allowing higher shutter speeds or smaller apertures.

ISO sensitivity can be adjusted by pressing the **ISO** button and rotating the main command dial until the desired setting is displayed in the control panel or viewfinder.

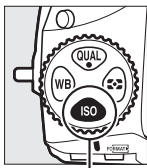

ISO button



Main command dial

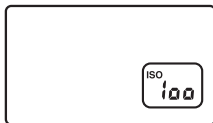

Control panel



Viewfinder

The Shooting Menu

ISO sensitivity can also be adjusted from the shooting menu. Choose **ISO sensitivity settings** to adjust settings for viewfinder and live view photography (☐ 290) and **Movie settings > Movie ISO sensitivity settings** to adjust settings for movie live view (☐ 64).

ISO Sensitivity

The higher the ISO sensitivity, the less light needed to make an exposure, allowing faster shutter speeds or smaller apertures, but the more likely the image is to be affected by noise (randomly-spaced bright pixels, fog, or lines). Noise is particularly likely at settings between **Hi 0.3** and **Hi 2**.

Hi 0.3–Hi 2

The settings **Hi 0.3** through **Hi 2** correspond to ISO sensitivities 0.3–2 EV over ISO 12800 (ISO 16000–51200 equivalent).

Lo 0.3–Lo 1

The settings **Lo 0.3** through **Lo 1** correspond to ISO sensitivities 0.3–1 EV below ISO 64 (ISO 50–32 equivalent). Use for larger apertures when lighting is bright. Contrast is slightly higher than normal; in most cases, ISO sensitivities of ISO 64 or above are recommended.

See Also

For information on choosing the ISO sensitivity step size, see Custom Setting b1 (**ISO sensitivity step value**; ☐ 315). For information on displaying ISO sensitivity in the control panel or adjusting ISO sensitivity without using the **ISO** button, see Custom Setting d8 (**ISO display and adjustment**; ☐ 325). For information on using the **High ISO NR** option in the shooting menu to reduce noise at high ISO sensitivities, see page 299.

Auto ISO Sensitivity Control

If **On** is selected for **ISO sensitivity settings** > **Auto ISO sensitivity control** in the shooting menu, ISO sensitivity will automatically be adjusted if optimal exposure can not be achieved at the value selected by the user (ISO sensitivity is adjusted appropriately when the flash is used).

- 1 Select Auto ISO sensitivity control.**
Select **ISO sensitivity settings** in the shooting menu, then highlight **Auto ISO sensitivity control** and press .

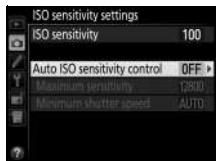

- 2 Select On.**
Highlight **On** and press  (if **Off** is selected, ISO sensitivity will remain fixed at the value selected by the user).

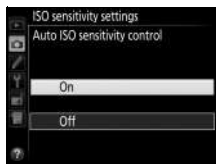

3 Adjust settings.

The maximum value for auto ISO sensitivity can be selected using **Maximum sensitivity** (note that if the ISO sensitivity selected by the user is higher than that chosen for **Maximum sensitivity**, the value selected by the user will be used instead). In exposure modes **P** and **A**, sensitivity will only be adjusted if underexposure would result at the shutter speed selected for **Minimum shutter speed** ($1/4000$ –30 s, or **Auto**; in modes **S** and **M**, ISO sensitivity will be adjusted for optimal exposure at the shutter speed selected by the user). If **Auto** is selected, the camera will choose the minimum shutter speed based on the focal length of the lens. Press **OK** to exit when settings are complete.

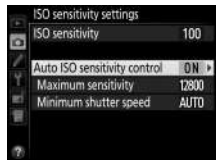

When **On** is selected, the viewfinder and control panel show **ISO-AUTO**.

When sensitivity is altered from the value selected by the user, these indicators flash and the altered value is shown in the viewfinder.

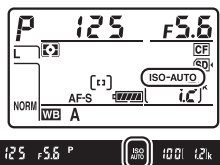

Minimum Shutter Speed

Auto shutter-speed selection can be fine-tuned by highlighting **Auto** and pressing \odot : for example, values faster than those usually selected automatically can be used with telephoto lenses to reduce blur. Note, however, that **Auto** functions only with CPU lenses; if a non-CPU lens is used without lens data, minimum shutter speed is fixed at $1/30$ s. Shutter speeds may drop below the selected minimum if optimum exposure can not be achieved at the ISO sensitivity chosen for **Maximum sensitivity**.

Enabling and Disabling Auto ISO Sensitivity Control

You can turn auto ISO sensitivity control on or off by pressing the **ISO** button and rotating the sub-command dial.

ISO-AUTO is displayed when auto ISO sensitivity control is on.

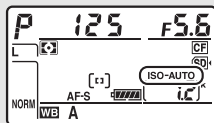





Auto ISO Sensitivity Control

Noise (randomly-spaced bright pixels, fog, or lines) is more likely at higher sensitivities. Use the **High ISO NR** option in the shooting menu to reduce noise (see page 299). When a flash is used, minimum shutter speed will be set to the value selected for **Minimum shutter speed** unless this value is faster than Custom Setting e1 (**Flash sync speed**, \square 329) or slower than Custom Setting e2 (**Flash shutter speed**, \square 331), in which case the value selected for Custom Setting e2 will be used instead. Note that ISO sensitivity may be raised automatically when auto ISO sensitivity control is used in combination with slow sync flash modes (available with the built-in flash and the optional flash units listed on page 428), possibly preventing the camera from selecting slow shutter speeds.

Exposure

Metering

Metering determines how the camera sets exposure. The following options are available:

Option	Description
	Matrix: Produces natural results in most situations. Camera meters a wide area of the frame and set exposure according to tone distribution, color, composition, and, with type G, E, or D lenses (☐ 422), distance information (3D color matrix metering III; with other CPU lenses, camera uses color matrix metering III, which does not include 3D distance information).
	Center-weighted: Camera meters entire frame but assigns greatest weight to center area (if CPU lens is attached, size of area can be selected using Custom Setting b6, Center-weighted area , ☐ 317; if non-CPU lens is attached, area is equivalent to circle 12 mm in diameter). Classic meter for portraits; recommended when using filters with an exposure factor (filter factor) over 1×.
	Spot: Camera meters circle 4 mm (0.16 in.) in diameter (approximately 1.5% of frame). Circle is centered on current focus point, making it possible to meter off-center subjects (if non-CPU lens is used or if auto-area AF is in effect, camera will meter center focus point). Ensures that subject will be correctly exposed, even when background is much brighter or darker.
	Highlight-weighted: Camera assigns greatest weight to highlights. Use to reduce loss of detail in highlights, for example when photographing spotlight performers on a stage.

To choose a metering option, press the  button and rotate the main command dial until the desired setting is displayed in the viewfinder and control panel.

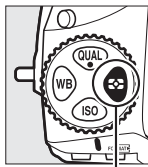

 button

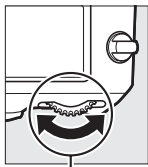

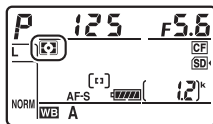

Main command dial



Non-CPU Lens Data

Specifying the focal length and maximum aperture of non-CPU lenses using the **Non-CPU lens data** option in the setup menu ( 229) allows the camera to use color matrix metering when matrix is selected and improves the accuracy of center-weighted and spot metering. Center-weighted metering will be used if highlight-weighted metering is selected with non-CPU lenses or if matrix metering is selected with non-CPU lenses for which lens data have not been supplied. Note that center-weighted metering may also be used if highlight-weighted metering is selected with certain CPU lenses (AI-P NIKKOR lenses and AF lenses that are not of type G, E, or D).





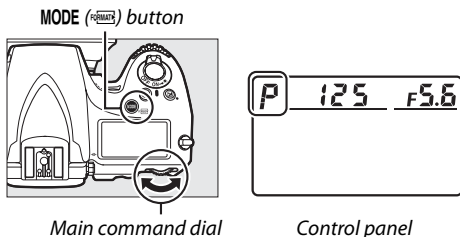

See Also

See Custom Setting b5 (**Matrix metering**,  317) for information on choosing whether matrix metering uses face detection. For information on making separate adjustments to optimal exposure for each metering method, see Custom Setting b7 (**Fine-tune optimal exposure**,  318).

Exposure Mode

To determine how the camera sets shutter speed and aperture when adjusting exposure, press the **MODE** () button and rotate the main command dial until the desired option appears in the control panel.



Mode	Description
P	Programmed auto ( 118): Camera sets shutter speed and aperture for optimal exposure. Recommended for snapshots and in other situations in which there is little time to adjust camera settings.
S	Shutter-priority auto ( 119): User chooses shutter speed; camera selects aperture for best results. Use to freeze or blur motion.
A	Aperture-priority auto ( 120): User chooses aperture; camera selects shutter speed for best results. Use to blur background or bring both foreground and background into focus.
M	Manual ( 121): User controls both shutter speed and aperture. Set shutter speed to Bulb (  ) or Time (- -) for long time-exposures.

Lens Types

When using a CPU lens equipped with an aperture ring (📖 422), lock the aperture ring at the minimum aperture (highest f-number). Type G and E lenses are not equipped with an aperture ring.

When using non-CPU lenses (📖 229), select exposure mode **A** (aperture-priority auto) or **M** (manual). In other modes, exposure mode **A** is automatically selected when a non-CPU lens is attached (📖 419, 424). The exposure mode indicator (**P** or **S**) will flash in the control panel and **A** will be displayed in the viewfinder.

Depth-of-Field Preview

To preview the effects of aperture, press and hold the **Pv** button. The lens will be stopped down to the aperture value selected by the camera (modes **P** and **S**) or the value chosen by the user (modes **A** and **M**), allowing depth of field to be previewed in the viewfinder.

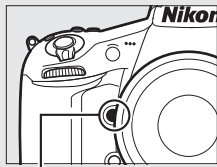

Pv button

Custom Setting e5—Modeling Flash

This setting controls whether the built-in flash and optional flash units that support the Nikon Creative Lighting System (CLS; 📖 428) will emit a modeling flash when the **Pv** button is pressed. See page 338 for more information.

P: Programmed Auto

In this mode, the camera automatically adjusts shutter speed and aperture according to a built-in program to ensure optimal exposure in most situations.

Flexible Program

In exposure mode **P**, different combinations of shutter speed and aperture can be selected by rotating the main command dial while the exposure meters are on (“flexible program”). Rotate the dial to the right for large apertures (low f-numbers) that blur background details or fast shutter speeds that “freeze” motion. Rotate the dial to the left for small apertures (high f-numbers) that increase depth of field or slow shutter speeds that blur motion. All combinations produce the same exposure. While flexible program is in effect, an asterisk (“*”) appears in the control panel. To restore default shutter speed and aperture settings, rotate the dial until the asterisk is no longer displayed, choose another mode, or turn the camera off.

See Also

See page 458 for information on the built-in exposure program. For information on activating the exposure meters, see “The Standby Timer” on page 34.

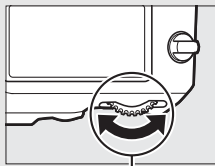

Main command dial

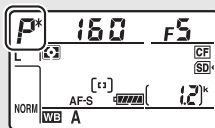

5: Shutter-Priority Auto

In shutter-priority auto, you choose the shutter speed while the camera automatically selects the aperture that will produce the optimal exposure.

To choose a shutter speed, rotate the main command dial while the exposure meters are on. Shutter speed can be set to "x 250" or to values between 30 s and $\frac{1}{8000}$ s. Shutter speed can be locked at the selected setting (☞ 126).

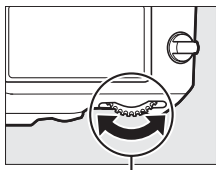

Main command dial

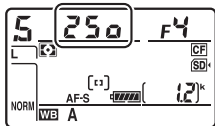

A: Aperture-Priority Auto

In aperture-priority auto, you choose the aperture while the camera automatically selects the shutter speed that will produce the optimal exposure.

To choose an aperture between the minimum and maximum values for the lens, rotate the sub-command dial while the exposure meters are on. Aperture can be locked at the selected setting (▢ 126).

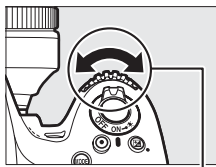

Sub-command dial

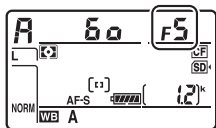

Non-CPU Lenses (▢ 419, 424)

Use the lens aperture ring to adjust aperture. If the maximum aperture of the lens has been specified using the **Non-CPU lens data** item in setup menu (▢ 230) when a non-CPU lens is attached, the current f-number will be displayed in the viewfinder and control panel, rounded to the nearest full stop. Otherwise the aperture displays will show only the number of stops (ΔF , with maximum aperture displayed as $\Delta F0$) and the f-number must be read from the lens aperture ring.

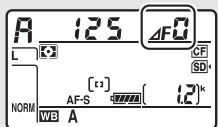

M: Manual

In manual exposure mode, you control both shutter speed and aperture. While the exposure meters are on, rotate the main command dial to choose a shutter speed, and the sub-command dial to set aperture. Shutter speed can be set to “x 250” or to values between 30 s and $1/8000$ s, or the shutter can be held open indefinitely for a long time-exposure (bulb or - -, 123). Aperture can be set to values between the minimum and maximum values for the lens. Use the exposure indicators to check exposure.

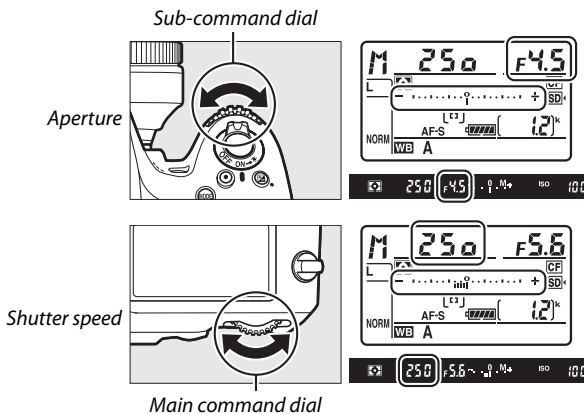

Shutter speed and aperture can be locked at the selected setting (126).

AF Micro NIKKOR Lenses

Provided that an external exposure meter is used, the exposure ratio need only be taken into account when the lens aperture ring is used to set aperture.

Exposure Indicators

If a shutter speed other than “bulb” or “time” is selected, the exposure indicators in the viewfinder and control panel show whether the photograph would be under- or over-exposed at current settings. Depending on the option chosen for Custom Setting b2 (**EV steps for exposure cntrl**,  315), the amount of under- or over-exposure is shown in increments of $\frac{1}{3}$ EV, $\frac{1}{2}$ EV, or 1 EV. If the limits of the exposure metering system are exceeded, the displays will flash.

Custom Setting b2 set to 1/3 step			
	Optimal exposure	Underexposed by $\frac{1}{3}$ EV	Overexposed by over 3 EV
Control panel	- 0 +	- 0 +	- 0 +
Viewfinder	- . . 0 . . +	- . . 0 . . +	- . . 0 +

See Also

For information on reversing the exposure indicators so that negative values are displayed on the right and positive values on the left, see Custom Setting f12 (**Reverse indicators**,  354).

Long Time-Exposures (M Mode Only)

Select the following shutter speeds for long time-exposures of moving lights, the stars, night scenery, or fireworks.

- **Bulb** (⏏ ⏏): The shutter remains open while the shutter-release button is held down. To prevent blur, use a tripod or an optional wireless remote controller (📖 441) or remote cord (📖 439).
- **Time** (- -): Start the exposure by using the shutter-release button on the camera or on an optional remote cord, or wireless remote controller. The shutter remains open until the button is pressed a second time.



Length of exposure: 35 s

Aperture: f/25

1 Ready the camera.

Mount the camera on a tripod or place it on a stable, level surface.

☑ Long Time-Exposures

Close the viewfinder eyepiece shutter to prevent light entering via the viewfinder from appearing in the photograph or interfering with exposure (☐ 106). Nikon recommends using a fully charged battery or an optional AC adapter and power connector to prevent loss of power while the shutter is open. Note that noise (bright spots, randomly-spaced bright pixels or fog) may be present in long exposures; before shooting, choose **On** for the **Long exposure NR** option in the shooting menu (☐ 299).

2 Select exposure mode *M*.

Press the **MODE** (FORMAT) button and rotate the main command dial until *M* is displayed in the control panel.

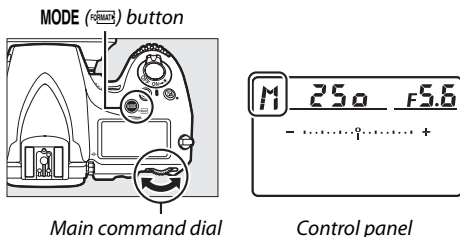

3 Choose a shutter speed.

While the exposure meters are on, rotate the main command dial to choose a shutter speed of Bulb (**b u l b**) or Time (- -). The exposure indicators do not appear when Bulb (**b u l b**) or Time (- -) is selected.

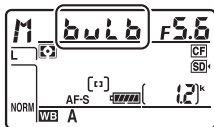

Bulb

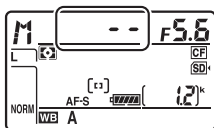

Time

4 Open the shutter.

Bulb: After focusing, press the shutter-release button on the camera or optional remote cord or wireless remote controller all the way down. Keep the shutter-release button pressed until the exposure is complete.

Time: Press the shutter-release button all the way down.

5 Close the shutter.

Bulb: Remove your finger from the shutter-release button.

Time: Press the shutter-release button all the way down.

Shutter-Speed and Aperture Lock

Shutter speed lock is available in shutter-priority auto and manual exposure modes, aperture lock in aperture-priority auto and manual exposure modes. Shutter speed and aperture lock are not available in programmed auto exposure mode.

- 1 Assign shutter speed and aperture lock to a camera control.** Select **Shutter spd & aperture lock** as the “press + command dials” option in the Custom Settings menu (☞ 348). Shutter speed and aperture lock can be assigned to the **Fn** button (Custom Setting f4, **Assign Fn button**, ☞ 343), the **Pv** button (Custom Setting f5, **Assign preview button**, ☞ 349), or the **AE-L/AF-L** button (Custom Setting f6, **Assign AE-L/AF-L button**, ☞ 349).

- 2 Lock shutter speed and/or aperture.**

Shutter speed (exposure modes S and M): Press the selected button and rotate the main command dial until **L** icons appear in the viewfinder and control panel.

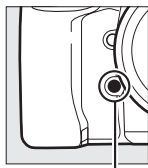

Fn button

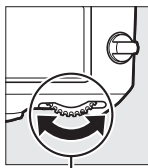

Main command dial

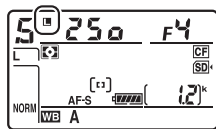

To unlock shutter speed, press the button and rotate the main command dial until the **L** icons disappear from the displays.

Aperture (exposure modes *A* and *M*): Press the selected button and rotate the sub-command dial until  icons appear in the viewfinder and the control panel.

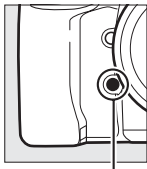

Fn button

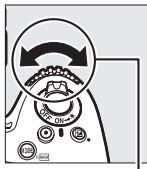

Sub-command dial

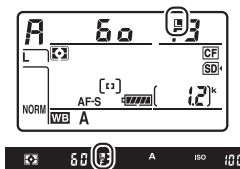

To unlock aperture, press the button and rotate the sub-command dial until the  icons disappear from the displays.

 **See Also**

Use Custom Setting f7 (**Shutter spd & aperture lock**;  350) to keep shutter speed and/or aperture locked at the selected values.

Autoexposure (AE) Lock

Use autoexposure lock to recompose photographs after using center-weighted metering and spot metering (114) to meter exposure.

1 Lock exposure.

Position the subject in the selected focus point and press the shutter-release button halfway. With the shutter-release button pressed halfway and the subject positioned in the focus point, press the AE-L/AF-L button to lock exposure (if you are using autofocus, confirm that the in-focus indicator (●) appears in the viewfinder).

While exposure lock is in effect, an **AE-L** indicator will appear in the viewfinder.

Shutter-release button

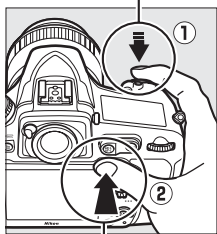

AE-L/AF-L button



2 Recompose the photograph.

Keeping the AE-L/AF-L button pressed, recompose the photograph and shoot.

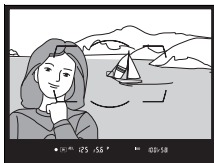

🔍 Metered Area

In spot metering, exposure will be locked at the value metered in a 4-mm (0.16 in.) circle centered on the selected focus point. In center-weighted metering, exposure will be locked at the value metered in a 12-mm circle in the center of the viewfinder.

🔍 Adjusting Shutter Speed and Aperture

While exposure lock is in effect, the following settings can be adjusted without altering the metered value for exposure:

Exposure mode	Setting
<i>P</i>	Shutter speed and aperture (flexible program; 📖 118)
<i>S</i>	Shutter speed
<i>A</i>	Aperture

The new values can be confirmed in the viewfinder and control panel. Note that the metering can not be changed while exposure lock is in effect.

🔍 See Also

If **On** is selected for Custom Setting c1 (**Shutter-release button AE-L**, 📖 319), exposure will lock when the shutter-release button is pressed halfway. For information on changing the role of the ^{AE-L}_{AF-L} **AE-L/AF-L** button, see Custom Setting f6 (**Assign AE-L/AF-L button**, 📖 349).

Exposure Compensation

Exposure compensation is used to alter exposure from the value suggested by the camera, making pictures brighter or darker. It is most effective when used with center-weighted or spot metering (📖 114). Choose from values between -5 EV (underexposure) and $+5$ EV (overexposure) in increments of $\frac{1}{3}$ EV. In general, positive values make the subject brighter while negative values make it darker.



-1 EV



*No exposure
compensation*



+1 EV

To choose a value for exposure compensation, press the  button and rotate the main command dial until the desired value is displayed in the control panel or viewfinder.

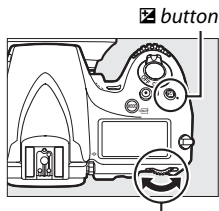

Main command dial

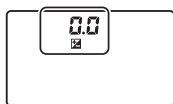

± 0 EV

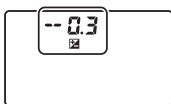

( button pressed)

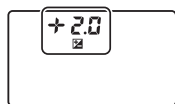

-0.3 ($-\frac{1}{3}$) EV



+2.0 EV

At values other than ± 0.0 , the 0 at the center of the exposure indicators will flash (exposure modes *P*, *S*, and *A* only) and a  icon will be displayed in the viewfinder and control panel after you release the  button. The current value for exposure compensation can be confirmed in the exposure indicator by pressing the  button.

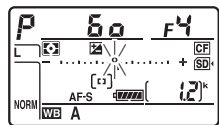

Normal exposure can be restored by setting exposure compensation to ± 0.0 . Exposure compensation is not reset when the camera is turned off.

Exposure Mode M

In exposure mode M, exposure compensation affects only the exposure indicator; shutter speed and aperture do not change.

See Also

For information on choosing the size of the increments available for exposure compensation, see Custom Setting b3 (**Exp./flash comp. step value**, □ 315). For information on making adjustments to exposure compensation without pressing the  button, see Custom Setting b4 (**Easy exposure compensation**, □ 316). For information on restricting the effects of exposure compensation to the background when using a flash for foreground lighting, see Custom Setting e4 (**Exposure comp. for flash**, □ 338). For information on automatically varying exposure, flash level, white balance, or Active D-Lighting, see page 133.

Bracketing

Bracketing automatically varies exposure, flash level, Active D-Lighting (ADL), or white balance slightly with each shot, “bracketing” the current value. Choose in situations in which it is difficult to set exposure, flash level (i-TTL and, where supported, auto aperture flash control modes only; see pages 194, 331, and 430), white balance, or Active D-Lighting and there is not time to check results and adjust settings with each shot, or to experiment with different settings for the same subject.

■ Exposure and Flash Bracketing

Vary exposure and/or flash level over a series of photographs.



Exposure modified by:
0 EV



Exposure modified by:
-1 EV



Exposure modified by:
+1 EV

- Select flash or exposure bracketing.** Select Custom Setting e6 (**Auto bracketing set**) in the Custom Settings menu, highlight an option, and press **OK**. Choose **AE & flash** to vary both exposure and flash level, **AE only** to vary only exposure, or **Flash only** to vary only flash level.

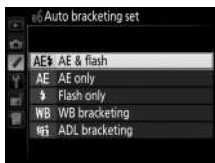
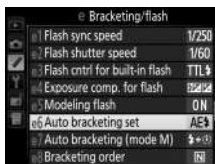

2 Choose the number of shots.

Pressing the **BKT** button, rotate the main command dial to choose the number of shots in the bracketing sequence. The number of shots is shown in the control panel.

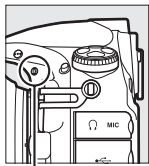

BKT button

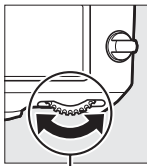

Main command
dial

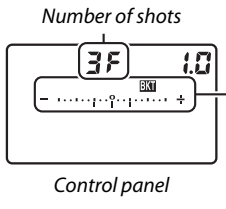

Exposure and flash
bracketing indicator

At settings other than zero, a **BKT** icon and exposure and flash bracketing indicator will appear in the control panel and **BKT** will be displayed in the viewfinder.



3 Select an exposure increment.

Pressing the **BKT** button, rotate the sub-command dial to choose the exposure increment.

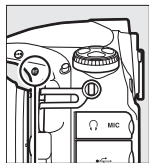

BKT button

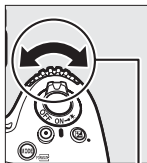

Sub-command dial

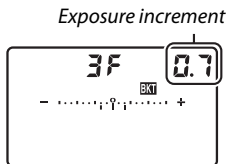

Control panel

At default settings, the size of the increment can be chosen from 0.3 ($\frac{1}{3}$), 0.7 ($\frac{2}{3}$), 1, 2, and 3 EV. The bracketing programs with an increment of 0.3 ($\frac{1}{3}$) EV are listed below.

Control panel display	No. of shots	Bracketing order (EVs)
0F 0.3 -o..... +	0	0
+ 3F 0.3 -i;..... +	3	0/+0.3/+0.7
-- 3F 0.3 -i;..... +	3	0/-0.7/-0.3
+ 2F 0.3 -i;..... +	2	0/+0.3
-- 2F 0.3 -i;..... +	2	0/-0.3
3F 0.3 -i;..... +	3	0/-0.3/+0.3
5F 0.3 -i;..... +	5	0/-0.7/-0.3/+0.3/+0.7
7F 0.3 -i;..... +	7	0/-1.0/-0.7/-0.3/+0.3/+0.7/+1.0
9F 0.3 -i;..... +	9	0/-1.3/-1.0/-0.7/-0.3/+0.3/+0.7/+1.0/+1.3

Note that for exposure increments of 2 EV or more, the maximum number of shots is 5; if a higher value was selected in Step 2, the number of shots will automatically be set to 5.

4 Frame a photograph, focus, and shoot.

The camera will vary exposure and/or flash level shot-by-shot according to the bracketing program selected. Modifications to exposure are added to those made with exposure compensation (see page 130).



While bracketing is in effect, a bracketing progress indicator will be displayed in the control panel. A segment will disappear from the indicator after each shot.

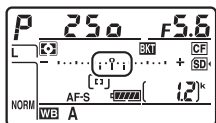

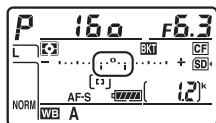

No. shots: 3; increment: 0.7



Display after first shot

See Also

For information on choosing the size of the exposure increment, see Custom Setting b2 (**EV steps for exposure cntrl**,  315). For information on choosing the order in which bracketing is performed, see Custom Setting e8 (**Bracketing order**,  340). For information on choosing the role of the **BKT** button, see Custom Setting f8 (**Assign BKT button**,  350).

■ ■ **Canceling Bracketing**

To cancel bracketing, press the **BKT** button and rotate the main command dial until the number of shots in the bracketing sequence is zero (0F) and **BKT** is no longer displayed. The program last in effect will be restored the next time bracketing is activated. Bracketing can also be cancelled by performing a two-button reset (☐ 206), although in this case the bracketing program will not be restored the next time bracketing is activated.

🔪 **Exposure and Flash Bracketing**

In continuous release modes (☐ 102), shooting will pause after the number of shots specified in the bracketing program have been taken. Shooting will resume the next time the shutter-release button is pressed. In self-timer mode, the camera will take the number of shots selected in Step 2 on page 134 each time the shutter-release button is pressed, regardless of the option selected for Custom Setting c3 (**Self-timer**) > **Number of shots** (☐ 319); the interval between shots is however controlled by Custom Setting c3 (**Self-timer**) > **Interval between shots**. In other modes, one shot will be taken each time the shutter-release button is pressed.

If the memory card fills before all shots in the sequence have been taken, shooting can be resumed from the next shot in the sequence after the memory card has been replaced or shots have been deleted to make room on the memory card. If the camera is turned off before all shots in the sequence have been taken, bracketing will resume from the next shot in the sequence when the camera is turned on.

Exposure Bracketing

The camera modifies exposure by varying shutter speed and aperture (programmed auto), aperture (shutter-priority auto), or shutter speed (aperture-priority auto, manual exposure mode). If **On** is selected for **ISO sensitivity settings > Auto ISO sensitivity control** (☐ 111) in modes *P*, *S*, and *A*, the camera will modify exposure by varying ISO sensitivity and only vary shutter speed and/or aperture if the limits of exposure system are exceeded. Custom Setting e7 (**Auto bracketing (mode M)**, ☐ 339) can be used to change how the camera performs exposure and flash bracketing in manual exposure mode. Bracketing can be performed by varying flash level together with shutter speed and/or aperture, or by varying flash level alone.

■ ■ White Balance Bracketing

The camera creates multiple copies of each photograph, each with a different white balance. For more information on white balance, see page 148.

- 1 Select white balance bracketing.**
Choose **WB bracketing** for Custom Setting e6 **Auto bracketing set**.

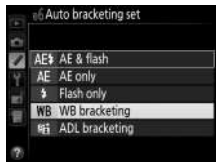

- 2 Choose the number of shots.**

Pressing the **BKT** button, rotate the main command dial to choose the number of shots in the bracketing sequence. The number of shots is shown in the control panel.

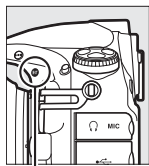

BKT button

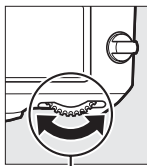

Main command dial

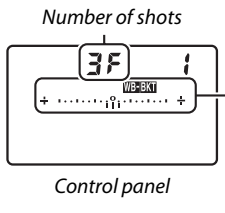

WB bracketing indicator

At settings other than zero, a **WB-BKT** icon and WB bracketing indicator will appear in the control panel and **BKT** will be displayed in the viewfinder.



3 Select a white balance increment.

Pressing the **BKT** button, rotate the sub-command dial to choose the white balance adjustment. Each increment is roughly equivalent to 5 mired.

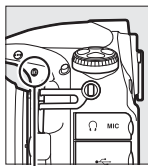

BKT button

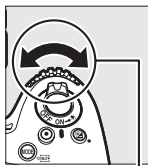

Sub-command dial

White balance increment

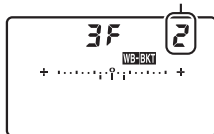

Control panel

Choose from increments of 1 (5 mired), 2 (10 mired), or 3 (15 mired). Higher **B** values correspond to increased amounts of blue, higher **A** values to increased amounts of amber (☞ 151). The bracketing programs with an increment of 1 are listed below.

Control panel display	No. of shots	White balance increment	Bracketing order
OF 1+°..... +	0	1	0
b3F 1+:i:..... +	3	1B	0/1B/2B
A3F 1+:i:..... +	3	1A	0/2A/1A
b2F 1+:i:..... +	2	1B	0/1B
A2F 1+:i:..... +	2	1A	0/1A
3F 1+:i:..... +	3	1A, 1B	0/1A/1B
5F 1+:i:..... +	5	1A, 1B	0/2A/1A/1B/2B
7F 1+:i:..... +	7	1A, 1B	0/3A/2A/1A/ 1B/2B/3B
9F 1+:i:..... +	9	1A, 1B	0/4A/3A/2A/1A/ 1B/2B/3B/4B

4 Frame a photograph, focus, and shoot.

Each shot will be processed to create the number of copies specified in the bracketing program, and each copy will have a different white balance. Modifications to white balance are added to the white balance adjustment made with white balance fine-tuning.



If the number of shots in the bracketing program is greater than the number of exposures remaining, **FULL** and the icon for the affected card will flash in the control panel, a flashing **FuL** icon will appear in the viewfinder as shown at right, and the shutter release will be disabled. Shooting can begin when a new memory card is inserted.

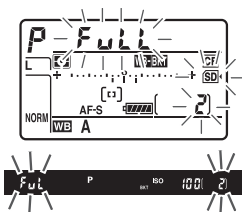

See Also

See page 154 for a definition of “mired.”

■ ■ **Canceling Bracketing**

To cancel bracketing, press the **BKT** button and rotate the main command dial until the number of shots in the bracketing sequence is zero (0F) and **WB-BKT** is no longer displayed. The program last in effect will be restored the next time bracketing is activated. Bracketing can also be cancelled by performing a two-button reset (☐ 206), although in this case the bracketing program will not be restored the next time bracketing is activated.

🔪 **White Balance Bracketing**

White balance bracketing is not available at an image quality of NEF (RAW). Selecting **NEF (RAW)**, **NEF (RAW) + JPEG fine**, **NEF (RAW) + JPEG normal**, or **NEF (RAW) + JPEG basic** cancels white balance bracketing.

White balance bracketing affects only color temperature (the amber-blue axis in the white balance fine-tuning display, ☐ 151). No adjustments are made on the green-magenta axis.

In self-timer mode, the number of copies specified in the white-balance program will be created each time the shutter is released, regardless of the option selected for Custom Setting c3 (**Self-timer**) > **Number of shots** (☐ 319).

If the camera is turned off while the memory card access lamp is lit, the camera will power off only after all photographs in the sequence have been recorded.

■ ■ ADL Bracketing

The camera varies Active D-Lighting over a series of exposures. For more information on Active D-Lighting, see page 182.

1 Select ADL bracketing.

Choose **ADL bracketing** for Custom Setting e6 **Auto bracketing set**.

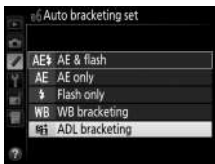

2 Choose the number of shots.

Pressing the **BKT** button, rotate the main command dial to choose the number of shots in the bracketing sequence. The number of shots is shown in the control panel.

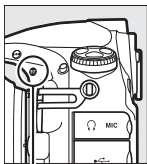

BKT button

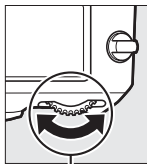

Main command dial

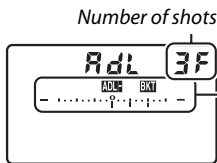

Control panel

ADL bracketing indicator

At settings other than zero, a **ADL-BKT** icon and an ADL bracketing indicator will appear in the control panel and **BKT** will be displayed in the viewfinder. Choose two shots to take one photograph with Active D-Lighting off and another at a selected value. Choose three to five shots to take a series of photographs with Active D-Lighting set to **Off**, **Low**, and **Normal** (three shots), **Off**, **Low**, **Normal**, and **High** (four shots), or **Off**, **Low**, **Normal**, **High**, and **Extra high** (five shots). If you choose more than two shots, proceed to Step 4.

3 Select Active D-Lighting.

Pressing the **BKT** button, rotate the sub-command dial to choose Active D-Lighting.

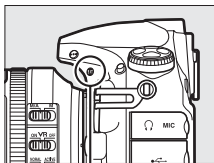



BKT button



Sub-command dial

Active D-Lighting is shown in the control panel.

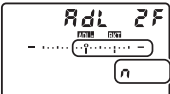
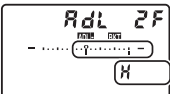
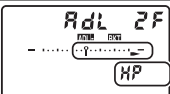
Control panel display	Active D-Lighting
	暗A Auto
	暗L Low
	暗N Normal
	暗H High
	暗H* Extra high

4 Frame a photograph, focus, and shoot.

The camera will vary Active D-Lighting shot-by-shot according to the bracketing program selected. While bracketing is in effect, a bracketing progress indicator will be displayed in the control panel. A segment will disappear from the indicator after each shot.

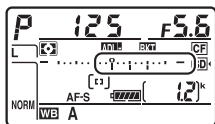

No. shots: 3

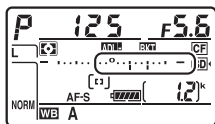

Display after first shot

■ Canceling Bracketing

To cancel bracketing, press the **BKT** button and rotate the main command dial until the number of shots in the bracketing sequence is zero (0F) and **ADL-BKT** is no longer displayed. The program last in effect will be restored the next time bracketing is activated. Bracketing can also be cancelled by performing a two-button reset (see 206), although in this case the bracketing program will not be restored the next time bracketing is activated.

ADL Bracketing







In continuous release modes (📖 102), shooting will pause after the number of shots specified in the bracketing program have been taken. Shooting will resume the next time the shutter-release button is pressed. In self-timer mode, the camera will take the number of shots selected in Step 2 on page 143 each time the shutter-release button is pressed, regardless of the option selected for Custom Setting c3 (**Self-timer**) > **Number of shots** (📖 319); the interval between shots is however controlled by Custom Setting c3 (**Self-timer**) > **Interval between shots**. In other modes, one shot will be taken each time the shutter-release button is pressed.

If the memory card fills before all shots in the sequence have been taken, shooting can be resumed from the next shot in the sequence after the memory card has been replaced or shots have been deleted to make room on the memory card. If the camera is turned off before all shots in the sequence have been taken, bracketing will resume from the next shot in the sequence when the camera is turned on.

White Balance

White Balance Options

White balance ensures that colors are unaffected by the color of the light source. Auto white balance is recommended with most light sources. If the desired results can not be achieved with auto white balance, choose an option from the list below.

	Option	Color temp.*
AUTO	Auto	3500–8000 K
	Normal	
	Keep warm lighting colors	
	Incandescent	3000 K
	Fluorescent	
	Sodium-vapor lamps	2700 K
	Warm-white fluorescent	3000 K
	White fluorescent	3700 K
	Cool-white fluorescent	4200 K
	Day white fluorescent	5000 K
	Daylight fluorescent	6500 K
	High temp. mercury-vapor	7200 K
	Direct sunlight	5200 K
	Flash	5400 K
	Cloudy	6000 K
	Shade	8000 K
	Choose color temp. (☐ 155)	2500–10,000 K
PRE	Preset manual (☐ 158)	—

* All values are approximate and do not reflect fine-tuning (if applicable).

White balance can be selected by pressing the **WB** button and rotating the main command dial until the desired setting is displayed in the control panel.

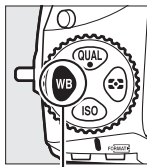

WB button

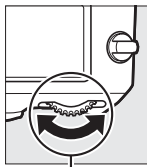

Main command dial

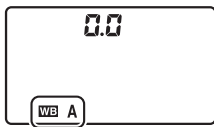

Control panel

The Shooting Menu

White balance can also be adjusted using the **White balance** option in the shooting menu (□ 290), which also can be used to fine-tune white balance (□ 151) or measure a value for preset manual white balance (□ 158). The **Auto** option in the **White balance** menu offers a choice of **Normal** and **Keep warm lighting colors**, which preserves the warm colors produced by incandescent lighting, while the  **Fluorescent** option can be used to select the light source from the bulb types.

Studio Flash Lighting

Auto white balance may not produce the desired results with large studio flash units. Use preset manual white balance or set white balance to **Flash** and use fine-tuning to adjust white balance.









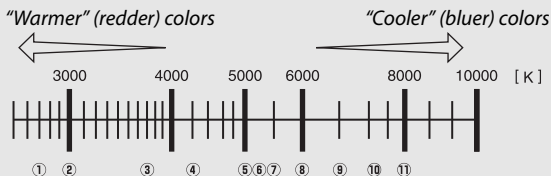



See Also

When **WB bracketing** is selected for Custom Setting e6 (**Auto bracketing set**, □ 338), the camera will create several images each time the shutter is released. White balance will be varied with each image, “bracketing” the value currently selected for white balance. See page 139 for more information.

Color Temperature

The perceived color of a light source varies with the viewer and other conditions. Color temperature is an objective measure of the color of a light source, defined with reference to the temperature to which an object would have to be heated to radiate light in the same wavelengths. While light sources with a color temperature in the neighborhood of 5000–5500 K appear white, light sources with a lower color temperature, such as incandescent light bulbs, appear slightly yellow or red. Light sources with a higher color temperature appear tinged with blue.



①	 (sodium-vapor lamps): 2700 K
②	 (incandescent)/  (warm-white fluorescent.): 3000 K
③	 (white fluorescent): 3700 K
④	 (cool-white fluorescent): 4200 K
⑤	 (day white fluorescent): 5000 K
⑥	 (direct sunlight): 5200 K
⑦	 (flash): 5400 K
⑧	 (cloudy): 6000 K
⑨	 (daylight fluorescent): 6500 K
⑩	 (high temp. mercury-vapor): 7200 K
⑪	 (shade): 8000 K

Note: All figures are approximate.

Fine-Tuning White Balance

At settings other than **☑ (Choose color temp.)**, white balance can be “fine-tuned” to compensate for variations in the color of the light source or to introduce a deliberate color cast into an image.

■ ■ The White Balance Menu

To fine-tune white balance from the shooting menu, select **White balance** and follow the steps below.

1 Display fine-tuning options.

Highlight a white balance option and press **⏏** (if a sub-menu is displayed, select the desired option and press **⏏** again to display fine-tuning options; for information on fine-tuning preset manual white balance, see page 169).

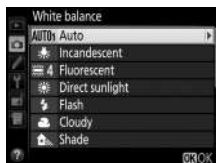

2 Fine-tune white balance.

Use the multi selector to fine-tune white balance. White balance can be fine-tuned on the amber (A)–blue (B) axis in steps of 0.5 and the green (G)–magenta (M) axis in steps of 0.25. The horizontal (amber-blue) axis corresponds to color temperature, while the vertical (green-magenta) axis has the similar effects to the corresponding color compensation (CC) filters. The horizontal axis is ruled in increments equivalent to about 5 mired, the vertical axis in increments of about 0.05 diffuse density units.

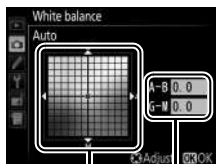

Coordinates

Adjustment

3 Press .

Press  to save settings and return to the shooting menu. If white balance has been fine-tuned, an asterisk ("*****") will be displayed in the control panel.

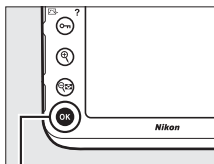

 button

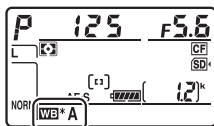

■ ■ The WB Button

At settings other than **☑ (Choose color temp.)** and **PRE (Preset manual)**, the **WB** button can be used to fine-tune white balance on the amber (A)–blue (B) axis (☞ 151; to fine-tune white balance when **PRE** is selected, use the shooting menu as described on page 151). Press the **WB** button and rotate the sub-command dial to fine-tune white balance in steps of 0.5 (with each full increment equivalent to about 5 mired), stopping when the desired value is displayed in the control panel. Rotate the dial left to increase the amount of amber (A), right to increase the amount of blue (B). At settings other than 0, an asterisk ("*****") appears in the control panel.

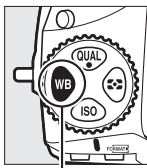

WB button

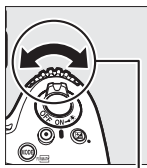

Sub-command
dial

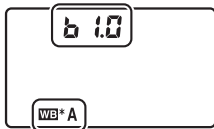

Control panel

White Balance Fine-Tuning

The colors on the fine-tuning axes are relative, not absolute. For example, moving the cursor to **B** (blue) when a “warm” setting such as  (**Incandescent**) is selected for white balance will make photographs slightly “colder” but will not actually make them blue.

“Mired”

Any given change in color temperature produces a greater difference in color at low color temperatures than it would at higher color temperatures. For example, a change of 1000 K produces a much greater change in color at 3000 K than at 6000 K. Mired, calculated by multiplying the inverse of the color temperature by 10^6 , is a measure of color temperature that takes such variation into account, and as such is the unit used in color-temperature compensation filters. E.g.:

- 4000 K–3000 K (a difference of 1000 K)=83 mired
- 7000 K–6000 K (a difference of 1000 K)=24 mired

Choosing a Color Temperature

Follow the steps below to choose a color temperature when **K** (Choose color temp.) is selected for white balance.

☑ Choose Color Temperature

Note that the desired results will not be obtained with flash or fluorescent lighting. Choose **⚡ (Flash)** or **☀ (Fluorescent)** for these sources. With other light sources, take a test shot to determine if the selected value is appropriate.

■ The White Balance Menu

Color temperature can be selected using the **White balance** options in the shooting menu. Enter values for the amber–blue and green–magenta axes (📖 151) as described below.

1 Select Choose color temp.

Select **White balance** in the shooting menu, then highlight **Choose color temp.** and press **▶**.

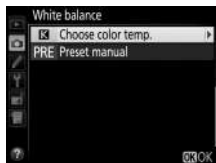

2 Select a value for amber-blue.

Press **⬅** or **➡** to highlight digits and press **⬆** or **⬇** to change.

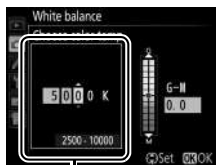

*Value for amber (A)-
blue (B) axis*

3 Select a value for green-magenta.

Press \leftarrow or \rightarrow to highlight the G (green) or M (magenta) axis and press \uparrow or \downarrow to select a value.

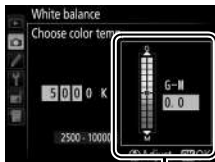



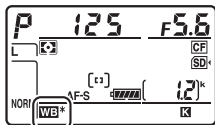

Value for green (G)-magenta (M) axis

4 Press OK .

Press OK to save changes and return to the shooting menu. If a value other than 0 is selected for the green (G)-magenta (M) axis, an asterisk ("*") will be displayed in the control panel.



■ ■ The WB Button

When **K** (**Choose color temp.**) is selected, the **WB** button can be used to select the color temperature, although only for the amber (A)–blue (B) axis. Press the **WB** button and rotate the sub-command dial until the desired value is displayed in the control panel (adjustments are made in mireds;  154). To enter a color temperature directly, press the **WB** button and press  or  to highlight a digit and press  or  to change.

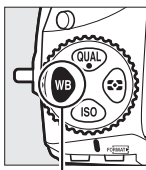

WB button

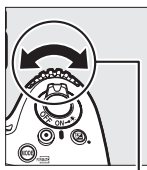

Sub-command
dial



Control panel

Preset Manual

Preset manual is used to record and recall custom white balance settings for shooting under mixed lighting or to compensate for light sources with a strong color cast. The camera can store up to six values for preset manual white balance in presets d-1 through d-6. Two methods are available for setting preset manual white balance:

Method	Description
Direct measurement	Neutral gray or white object is placed under lighting that will be used in final photo and white balance is measured by camera (☐ 159). In live view photography and movie live view (☐ 35, 49), white balance can be measured in a selected area of the frame (spot white balance, ☐ 163).
Copy from existing photograph	White balance is copied from photo on memory card (☐ 167).

White Balance Presets

Changes to white balance presets apply to all shooting menu banks (☐ 291).

Viewfinder Photography

1 Light a reference object.

Place a neutral gray or white object under the lighting that will be used in the final photograph. In studio settings, a standard gray panel can be used as a reference object. Note that exposure is automatically increased by 1 EV when measuring white balance; in exposure mode *M*, adjust exposure so that the exposure indicator shows ± 0 (☞ 122).

2 Set white balance to PRE (Preset manual).

Press the **WB** button and rotate the main command dial until **PRE** is displayed in the control panel.

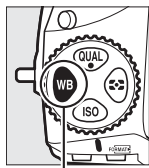

WB button

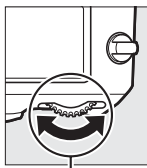

Main command dial

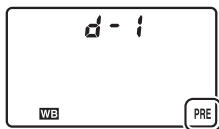

Control panel

Measuring Preset Manual White Balance (Viewfinder Photography)

Preset manual white balance can not be measured while you are shooting an HDR photograph (☞ 184) or multiple exposure (☞ 209), or when **Record movies** is selected for Custom Setting g4 (**Assign shutter button**, ☞ 364) and the live view selector is rotated to .

3 Select a preset.

Press the **WB** button and rotate the sub-command dial until the desired white balance preset (d-1 to d-6) is displayed in the control panel.

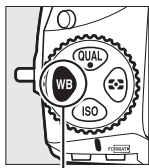

WB button

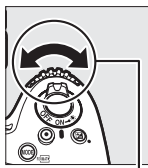

Sub-command dial

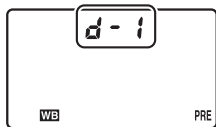

Control panel

4 Select direct measurement mode.

Release the **WB** button briefly and then press the button until the **PRE** icon in the control panel starts to flash. A flashing **PcE** will also appear in the viewfinder. The displays will flash for about six seconds.

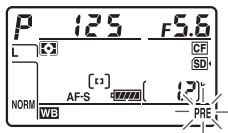

Control panel



Viewfinder

5 Measure white balance.

Before the indicators stop flashing, frame the reference object so that it fills the viewfinder and press the shutter-release button all the way down. The camera will measure a value for white balance and store it in the preset selected in Step 3. No photograph will be recorded; white balance can be measured accurately even when the camera is not in focus.



6 Check the results.

If the camera was able to measure a value for white balance, **Good** will flash in the control panel for about six seconds, while the viewfinder will show a flashing **Gd**.



Control panel



Viewfinder

If lighting is too dark or too bright, the camera may be unable to measure white balance. A flashing **no Gd** will appear in the control panel and viewfinder for about six seconds. Press the shutter-release button halfway to return to Step 5 and measure white balance again.

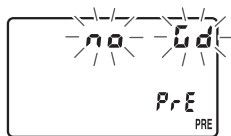

Control panel



Viewfinder

✔ Direct Measurement Mode

If no operations are performed during viewfinder photography while the displays are flashing, direct measurement mode will end in the time selected for Custom Setting c2 (**Standby timer**, □ 319).

✎ Protected Presets

If the current preset is protected (□ 169), **P**, **r**, **z** will flash in the control panel and viewfinder if you attempt to measure a new value.

✎ Selecting a Preset

Selecting **Preset manual** for the **White balance** option in the shooting menu displays the dialog shown at right; highlight a preset and press **OK**. If no value currently exists for the selected preset, white balance will be set to 5200 K, the same as **Direct sunlight**.



Live View (Spot White Balance)

In live view photography and movie live view (📖 35, 49), white balance can be measured in a selected area of the frame, eliminating the need to prepare a reference object or change lenses during telephoto photography.

1 Press the **Lv button.**

The mirror will be raised and the view through the lens will be displayed in the camera monitor.

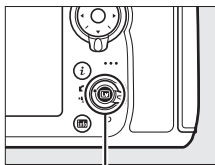

Lv button

2 Set white balance to PRE (Preset manual).

Press the **WB** button and rotate the main command dial until **PRE** is displayed in the control panel.

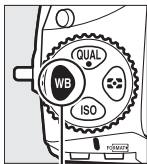

WB button

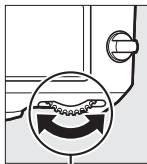

Main command
dial

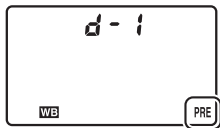

Control panel

3 Select a preset.

Press the **WB** button and rotate the sub-command dial until the desired white balance preset (d-1 to d-6) is displayed in the control panel.

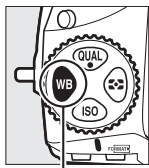

WB button

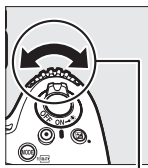

Sub-command
dial

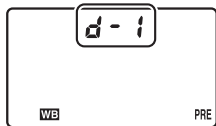

Control panel

4 Select direct measurement mode.

Release the **WB** button briefly and then press the button until the **PRE** icon in the control panel starts to flash. A spot white balance target (□) will be displayed at the selected focus point.

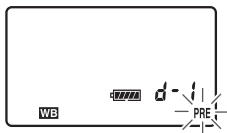

Control panel

5 Position the target over a white or grey area.

While **PRE** flashes in the display, use the multi selector to position the □ over a white or grey area of the subject. To zoom the area around the target in for more precise positioning, press the **Ⓜ** button.



6 Measure white balance.

Press the center of the multi selector or press the shutter-release button all the way down to measure white balance. The time available to measure white balance is that selected for Custom Setting c4 (**Monitor off delay**) > **Live view** (📖 320).



If the camera is unable to measure white balance, the message shown at right will be displayed. Choose a new white balance target and repeat the process from Step 5.



7 Exit direct measurement mode.

Press the **WB** button to exit direct measurement mode.

When **Preset manual** is selected for **White balance** in the shooting menu, the position of the target used to measure preset manual white balance will be displayed on presets recorded during live view photography and movie live view.



Measuring Preset Manual White Balance (Live View)

Preset manual white balance can not be measured when **Record movies** is selected for Custom Setting g4 (**Assign shutter button**, □ 364) and the live view selector is rotated to . Preset manual white balance can not be set while an HDR exposure is in progress (□ 184) or when a setting other than **None** is selected for photo live view display white balance (monitor hue; □ 43).

Managing Presets

■ Copying White Balance from a Photograph

Follow the steps below to copy a value for white balance from an existing photograph to a selected preset.

1 Select **Preset manual**.

Select **White balance** in the shooting menu, then highlight **Preset manual** and press .

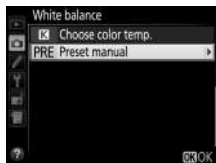

2 Select a destination.

Highlight the destination preset (d-1 to d-6) and press the center of the multi selector.



3 Choose **Select image**.

Highlight **Select image** and press .

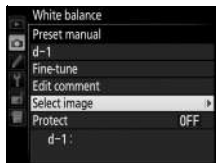

4 Highlight a source image.

Highlight the source image.



5 Copy white balance.

Press **OK** to copy the white balance value for the highlighted photograph to the selected preset. If the highlighted photograph has a comment (📖 375), the comment will be copied to the comment for the selected preset.

Choosing a Source Image

To view the image highlighted in Step 4 full frame, press and hold the **Q** button.

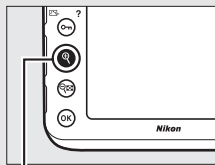

Q button



To view images in other locations, press **Q**. The dialog shown below will be displayed; select the desired card and folder.

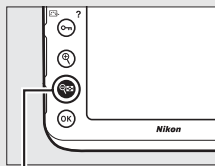

Q button



✎ Choosing a White Balance Preset

Press \odot to highlight the current white balance preset (d-1–d-6) and press \blacktriangleright to select another preset.

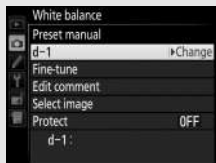

✎ Fine-Tuning Preset Manual White Balance

The selected preset can be fine-tuned by selecting **Fine-tune** and adjusting white balance as described on page 151.

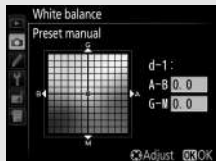

✎ Edit Comment

To enter a descriptive comment of up to 36 characters for the current white-balance preset, select **Edit comment** in the preset manual white balance menu and enter a comment as described on page 178.

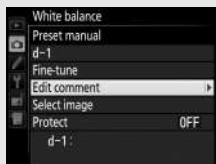

✎ Protect

To protect the current white-balance preset, select **Protect** in the preset manual white balance menu, then highlight **On** and press \odot . Protected presets can not be modified and the **Fine-tune** and **Edit comment** options can not be used.

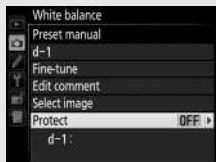









Image Enhancement

Picture Controls

Selecting a Picture Control

Choose a Picture Control according to the subject or type of scene.

Option	Description
 SD Standard	Standard processing for balanced results. Recommended for most situations.
 NL Neutral	Minimal processing for natural results. Choose for photographs that will later be processed or retouched.
 VI Vivid	Pictures are enhanced for a vivid, photoprint effect. Choose for photographs that emphasize primary colors.
 MC Monochrome	Take monochrome photographs.
 PT Portrait	Process portraits for skin with natural texture and a rounded feel.
 LS Landscape	Produces vibrant landscapes and cityscapes.
 FL Flat	Details are preserved over a wide tone range, from highlights to shadows. Choose for photographs that will later be extensively processed or retouched.

1 Press (P/?).

A list of Picture Controls will be displayed.

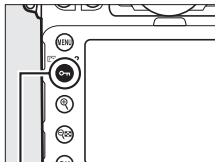

 (P/?) button



2 Select a Picture Control.

Highlight a Picture Control and press .

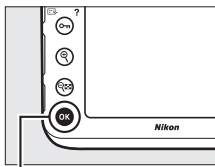

 button



Custom Picture Controls

Custom Picture Controls are created through modifications to existing Picture Controls using the **Manage Picture Control** option in the shooting menu (☐ 177). Custom Picture Controls can be saved to a memory card for sharing among other cameras of the same model and compatible software (☐ 180).

The Picture Control Indicator

The current Picture Control is shown in the information display when the  button is pressed.

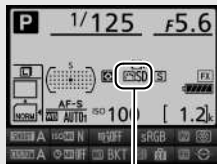

Picture Control indicator

The Shooting Menu

Picture Controls can also be selected using the **Set Picture Control** option in the shooting menu (☐ 290).

Modifying Picture Controls

Existing preset or custom Picture Controls (📖 177) can be modified to suit the scene or the user's creative intent. Choose a balanced combination of settings using **Quick adjust**, or make manual adjustments to individual settings.

1 Select a Picture Control.

Highlight the desired Picture Control in the Picture Control list (📖 170) and press **OK**.



2 Adjust settings.

Press **Up** or **Down** to highlight the desired setting and press **Left** or **Right** to choose a value in increments of 1, or rotate the sub-command dial to choose a value in increments of 0.25 (📖 174).

Repeat this step until all settings have been adjusted, or select a preset combination of settings by using the multi selector to choose **Quick adjust**. Default settings can be restored by pressing the **Reset** (🔄) button.



3 Press **OK**.

☑ Modifications to Original Picture Controls

Picture Controls that have been modified from default settings are indicated by an asterisk ("*") in the **Set Picture Control** menu.



Picture Control Settings

Option	Description	
Quick adjust	Mute or heighten the effect of the selected Picture Control (note that this resets all manual adjustments). Not available with Neutral, Monochrome, Flat , or custom Picture Controls (□ 177).	
Manual adjustments (all Picture Controls)	Sharpening	Control the sharpness of outlines. Select A to adjust sharpening automatically according to the type of scene.
	Clarity	Adjust clarity manually or select A to let the camera adjust clarity automatically. Depending on the scene, shadows may appear around bright objects or halos may appear around dark objects at some settings. Clarity is not applied to movies.
	Contrast	Adjust contrast manually or select A to let the camera adjust contrast automatically.
	Brightness	Raise or lower brightness without loss of detail in highlights or shadows.
Manual adjustments (non-monochrome only)	Saturation	Control the vividness of colors. Select A to adjust saturation automatically according to the type of scene.
	Hue	Adjust hue.
Manual adjustments (monochrome only)	Filter effects	Simulate the effect of color filters on monochrome photographs (□ 175).
	Toning	Choose the tint used in monochrome photographs (□ 176).

☑ "A" (Auto)

Results for auto sharpening, clarity, contrast, and saturation vary with exposure and the position of the subject in the frame. Use a type G, E, or D lens for best results.

🔍 Switching Between Manual and Auto

Press the  button to switch back and forth between manual and auto (A) settings for sharpening, clarity, contrast, and saturation.



🔍 Previous Settings

The  indicator under the value display in the Picture Control setting menu indicates the previous value for the setting. Use this as a reference when adjusting settings.





🔍 Filter Effects (Monochrome Only)

The options in this menu simulate the effect of color filters on monochrome photographs. The following filter effects are available:

Option	Description
Y Yellow	Enhances contrast. Can be used to tone down the
O Orange	brightness of the sky in landscape photographs. Orange
R Red	produces more contrast than yellow, red more contrast
G Green	than orange. Softens skin tones. Can be used for portraits.

Note that the effects achieved with **Filter effects** are more pronounced than those produced by physical glass filters.

Toning (Monochrome Only)

Pressing  when **Toning** is selected displays saturation options. Press  or  to adjust saturation in increments of 1, or rotate the sub-command dial to choose a value in increments of 0.25. Saturation control is not available when **B&W** (black-and-white) is selected.



Custom Picture Controls

The options available with custom Picture Controls are the same as those on which the custom Picture Control was based.

Creating Custom Picture Controls

The preset Picture Controls supplied with the camera can be modified and saved as custom Picture Controls.

- 1 Select Manage Picture Control.**
Highlight **Manage Picture Control** in the shooting menu and press \odot .



- 2 Select Save/edit.**
Highlight **Save/edit** and press \odot .

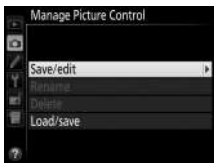

- 3 Select a Picture Control.**
Highlight an existing Picture Control and press \odot , or press \odot to proceed to Step 5 to save a copy of the highlighted Picture Control without further modification.



- 4 Edit the selected Picture Control.**
See page 174 for more information. To abandon any changes and start over from default settings, press the FORMAT button. Press \odot when settings are complete.







5 Select a destination.

Choose a destination for the custom Picture Control (C-1 through C-9) and press .



6 Name the Picture Control.

The text-entry dialog shown at right will be displayed. By default, new Picture Controls are named by adding a two-digit number (assigned automatically) to the name of the existing Picture Control; to use the default name, proceed to Step 7. To move the cursor in the name area, hold the  button and press  or . To enter a new letter at the current cursor position, use the multi selector to highlight the desired character in the keyboard area and press the center of the multi selector. To delete the character at the current cursor position, press the  () button.

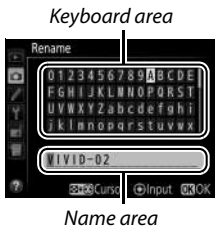

Custom Picture Control names can be up to nineteen characters long. Any characters after the nineteenth will be deleted.

7 Save changes and exit.

Press **OK** to save changes and exit.

The new Picture Control will appear in the Picture Control list.

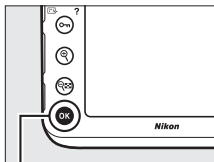

OK button



Manage Picture Control > Rename

Custom Picture Controls can be renamed at any time using the **Rename** option in the **Manage Picture Control** menu.

Manage Picture Control > Delete

The **Delete** option in the **Manage Picture Control** menu can be used to delete selected custom Picture Controls when they are no longer needed.

The Original Picture Control Icon

The original preset Picture Control on which the custom Picture Control is based is indicated by an icon in the top right corner of the edit display.

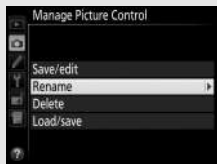

*Original
Picture Control icon*



Sharing Custom Picture Controls

Use the **Load/save** option in the **Manage Picture Control** menu to copy custom Picture Controls to and from memory cards. Custom Picture Controls can be created on a computer using Picture Control Utility 2, a utility launched from ViewNX 2 (supplied) or Capture NX-D, then saved to a memory card and copied to the camera. Custom Picture Controls created on the camera can be copied to a memory card for use in other D810s. Once the copies are no longer needed, they can be deleted using the **Delete from card** option.

To copy custom Picture Controls to or from the memory card, or to delete custom Picture Controls from the memory card, highlight **Load/Save** in the **Manage Picture Control** menu and press **OK**. The following options will be displayed:

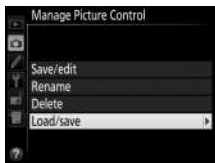

- **Copy to camera:** Copy custom Picture Controls from the memory card to custom Picture Controls C-1 through C-9 on the camera and name them as desired.
- **Delete from card:** Delete selected custom Picture Controls from the memory card. The confirmation dialog shown at right will be displayed before a Picture Control is deleted; to delete the selected Picture Control, highlight **Yes** and press **OK**.
- **Copy to card:** Copy a custom Picture Control (C-1 through C-9) from the camera to a selected destination (1 through 99) on the memory card.



Saving Custom Picture Controls

Up to 99 custom Picture Controls can be stored on the memory card at any one time. The memory card can only be used to store user-created custom Picture Controls. The preset Picture Controls supplied with the camera (☞ 170) can not be copied to the memory card, renamed, or deleted.

Preserving Detail in Highlights and Shadows

Active D-Lighting

Active D-Lighting preserves details in highlights and shadows, creating photographs with natural contrast. Use for high contrast scenes, for example when photographing brightly lit outdoor scenery through a door or window or taking pictures of shaded subjects on a sunny day. It is most effective when used with matrix metering (☞ 114).



Active D-Lighting off



Active D-Lighting: 暗 A Auto

“Active D-Lighting” versus “D-Lighting”

The **Active D-Lighting** option in the shooting menu adjusts exposure before shooting to optimize the dynamic range, while the **D-Lighting** option in the retouch menu (☞ 388) brightens shadows in images after shooting.





To use Active D-Lighting:

1 Select Active D-Lighting.

Highlight **Active D-Lighting** in the shooting menu and press .



2 Choose an option.



Highlight the desired option and press . If  **Auto** is selected, the camera will automatically adjust Active D-Lighting according to shooting conditions (in exposure mode *M*, however,  **Auto** is equivalent to  **Normal**).



Active D-Lighting

Active D-Lighting can not be used with movies. Noise (randomly-spaced bright pixels, fog, or lines) may appear in photographs taken with Active D-Lighting. With some subjects, you may notice uneven shading, shadows around bright objects, or halos around dark objects. Active D-Lighting can not be used at ISO sensitivities of Hi 0.3 or above.

See Also

When **ADL bracketing** is selected for Custom Setting e6 (**Auto bracketing set**,  338), the camera varies Active D-Lighting over a series of shots ( 143).

High Dynamic Range (HDR)

Used with high-contrast subjects, High Dynamic Range (HDR) preserves details in highlights and shadows by combining two shots taken at different exposures. HDR is most effective when used with matrix metering (☞ 114; with spot or center-weighted metering and a non-CPU lens, an exposure differential of **Auto** is equivalent to about 2 EV). It can not be used to record NEF (RAW) images. Movie recording (☞ 49), flash lighting, bracketing (☞ 133), multiple exposure (☞ 209), and time-lapse photography (☞ 223) can not be used while HDR is in effect and shutter speeds of $\frac{1}{250}$ and - - are not available.



+



First exposure (darker)

*Second exposure
(brighter)*

Combined HDR image

1 Select HDR (high dynamic range).

Highlight **HDR (high dynamic range)** in the shooting menu and press \odot .



2 Select a mode.

Highlight **HDR mode** and press .



Highlight one of the following and press .

- **To take a series of HDR photographs, select  On (series).** HDR shooting will continue until you select **Off** for **HDR mode**.
- **To take one HDR photograph, select **On (single photo)**.** Normal shooting will resume automatically after you have created a single HDR photograph.
- **To exit without creating additional HDR photographs, select **Off**.**



If **On (series)** or **On (single photo)** is selected, a  icon will be displayed in the control panel.

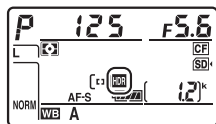

3 Choose the exposure differential.

To choose the difference in exposure between the two shots, highlight **Exposure differential** and press \odot .



The options shown at right will be displayed. Highlight an option and press \odot . Choose higher values for high-contrast subjects, but note that choosing a value higher than required may not produce the desired results; if **Auto** is selected, the camera will automatically adjust exposure to suit the scene.

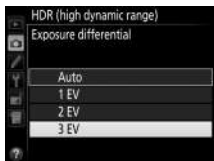

4 Choose the amount of smoothing.

To choose how much the boundaries between the two images are smoothed, highlight **Smoothing** and press \odot .



The options shown at right will be displayed. Highlight an option and press \odot . Higher values produce a smoother composite image. Uneven shading may be visible with some subjects.



5 Frame a photograph, focus, and shoot.

The camera takes two exposures when the shutter-release button is pressed all the way down. **Job HDR** will flash in the control panel and **Job Hdr** in the viewfinder while the images are combined; no photographs can be taken until recording is complete. Regardless of the option currently selected for release mode, only one photograph will be taken each time the shutter-release button is pressed.

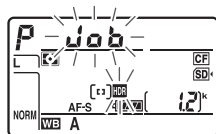

Control panel







Viewfinder

If **On (series)** is selected, HDR will only turn off when **Off** is selected for **HDR mode**; if **On (single photo)** is selected, HDR turns off automatically after the photograph is taken. The **HDR** icon clears from the display when HDR shooting ends.

Framing HDR Photographs

The edges of the image may be cropped out. The desired results may not be achieved if the camera or subject moves during shooting. Use of a tripod is recommended. Depending on the scene, shadows may appear around bright objects or halos may appear around dark objects; this effect can be reduced by adjusting the amount of smoothing.

The BKT Button



If **HDR (high dynamic range)** is selected for Custom Setting f8 (**Assign BKT button**;  350), you can select the HDR mode by pressing the **BKT** button and rotating the main command dial and the exposure differential by pressing the **BKT** button and rotating the sub-command dial. The mode and exposure differential are shown in the control panel:  and  appear when **On (series)** is selected and  when **On (single photo)** is selected; no icon appears when HDR is off.



Interval Timer Photography

If **On (series)** is selected for **HDR mode** before interval timer shooting begins, the camera will continue to shoot HDR photographs at the selected interval (if **On (single photo)** is selected, interval timer shooting will end after a single shot).

Shooting Menu Banks

HDR settings can be adjusted separately for each bank ( 291), but switching to a bank in which HDR is active during multiple exposure ( 209) or interval timer shooting ( 216) disables HDR. HDR is also disabled if you switch to a bank in which an NEF (RAW) option is selected for image quality.

Flash Photography

Using the Built-in Flash

The built-in flash can be used not only when natural lighting is inadequate but to fill in shadows and backlit subjects or to add a catch light to the subject's eyes.

1 Choose a metering method (📖 114).

Select matrix, center-weighted, or highlight-weighted metering to activate i-TTL balanced fill-flash for digital SLR. Standard i-TTL flash for digital SLR is activated automatically when spot metering is selected.

2 Press the flash pop-up button.

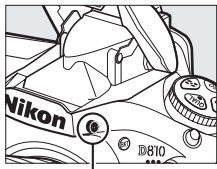

The built-in flash will pop up and begin charging. When the flash is fully charged, the flash-ready indicator (⚡) will light.





Flash pop-up button

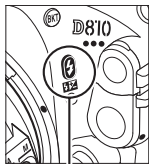

3 Choose a flash mode.

Press the  button and rotate the main command dial until the desired flash mode icon is displayed in the control panel ( 191).



 button

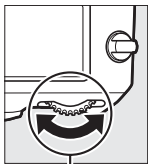

Main command dial

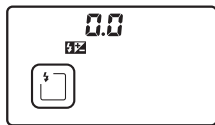

Control panel

4 Check exposure (shutter speed and aperture).

Press the shutter-release button halfway and check shutter speed and aperture. The settings available when the built-in flash is raised are listed on page 193.

The effects of the flash can be previewed by pressing the **Pv** button to emit a modeling flash ( 338).

5 Take the picture.

Compose the photograph, focus, and shoot.



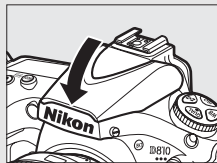

Lowering the Built-in Flash



To save power when the flash is not in use, press it gently downward until the latch clicks into place.



Flash Modes

The camera supports the following flash modes:

Flash mode	Description
 Front-curtain sync	This mode is recommended for most situations. In programmed auto and aperture-priority auto modes, shutter speed will automatically be set to values between $\frac{1}{250}$ and $\frac{1}{60}$ s ($\frac{1}{8000}$ to $\frac{1}{60}$ s when an optional flash unit is used with Auto FP High-Speed Sync;  329).
 Red-eye reduction	Red-eye reduction lamp lights for approximately one second before main flash. Pupils in subject's eyes contract, reducing "red-eye" effect sometimes caused by flash. Owing to one-second shutter-release delay, this mode is not recommended with moving subjects or in other situations in which quick shutter response is required. Avoid moving camera while red-eye reduction lamp is lit.
 Red-eye reduction with slow sync	Combines red-eye reduction with slow sync. Use for portraits taken against a backdrop of night scenery. Available only in programmed auto and aperture-priority auto exposure modes. Use of a tripod is recommended to prevent blurring caused by camera shake.
 Slow sync	Flash is combined with shutter speeds as slow as 30 s to capture both subject and background at night or under dim light. This mode is only available in programmed auto and aperture-priority auto exposure modes. Use of tripod is recommended to prevent blurring caused by camera shake.

Flash mode	Description
 Rear-curtain sync	 <p>In shutter-priority auto or manual exposure mode, flash fires just before the shutter closes. Use to create effect of a stream of light behind moving objects. In programmed auto and aperture-priority auto, slow rear-curtain sync is used to capture both subject and background. Use of tripod is recommended to prevent blurring caused by camera shake.</p>
 Flash off	The flash does not fire.

The Built-in Flash

See page 425 for information on the lenses that can be used with the built-in flash. Remove lens hoods to prevent shadows. The flash has a minimum range of 0.6 m (2 ft) and can not be used in the macro range of zoom lenses with a macro function.

i-TTL flash control is available at ISO sensitivities between 64 and 12800; at other sensitivities, the desired results may not be achieved at some ranges or aperture values.

If the flash fires in continuous release modes ( 102), only one photograph will be taken each time the shutter-release button is pressed.

The shutter release may be briefly disabled to protect the flash after it has been used for several consecutive shots. The flash can be used again after a short pause.

Flash Photography Shutter Speed and Aperture

Mode	Shutter speed	Aperture	See page
P	Set automatically by camera ($1/250$ s– $1/60$ s) ^{1,2}	Set automatically by camera	118
S	Value selected by user ($1/250$ s–30 s) ²		119
A	Set automatically by camera ($1/250$ s– $1/60$ s) ^{1,2}	Value selected by user ³	120
M	Value selected by user ($1/250$ s–30 s, ∞ , ∞ , ∞) ²		121





- 1 Shutter speed may be set as slow as 30 s in slow sync, slow rear-curtain sync, and slow sync with red-eye reduction flash modes.
- 2 Speeds as fast as $1/8000$ s are available with optional flash units that support auto FP high-speed sync (□ 430) when **1/320 s (Auto FP)** or **1/250 s (Auto FP)** is selected for Custom Setting e1 (**Flash sync speed**, □ 329).
- 3 Flash range varies with aperture and ISO sensitivity. Consult table of flash ranges (□ 195) when setting aperture in A and M modes.

Flash Control Mode

The camera supports the following i-TTL flash control modes:

- **i-TTL balanced fill-flash for digital SLR:** Flash emits series of nearly invisible preflashes (monitor preflashes) immediately before main flash. Preflashes reflected from objects in all areas of frame are picked up by RGB sensor with approximately 91K (91,000) pixels and are analyzed in combination with range information from matrix metering system to adjust flash output for natural balance between main subject and ambient background lighting. If type G, E, or D lens is used, distance information is included when calculating flash output. Precision of calculation can be increased for non-CPU lenses by providing lens data (focal length and maximum aperture; see [□ 229](#)). Not available when spot metering is used.
- **Standard i-TTL flash for digital SLR:** Flash output adjusted to bring lighting in frame to standard level; brightness of background is not taken into account. Recommended for shots in which main subject is emphasized at expense of background details, or when exposure compensation is used. Standard i-TTL flash for digital SLR is activated automatically when spot metering is selected.

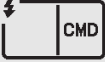
The flash control mode for the built-in flash can be selected using Custom Setting e3 (**Flash ctrl for built-in flash**, [□ 331](#)). The information display shows the flash control mode for the built-in flash as follows:

	Flash sync	Auto FP (□ 329, 330)
i-TTL		—
Manual		—
Repeating flash		—
Commander mode		

See Also

See page 198 for information on locking flash value (FV) for a metered subject before recomposing a photograph.

For information on auto FP high-speed sync and choosing a flash sync speed, see Custom Setting e1 (**Flash sync speed**, [□ 329](#)). For information on choosing the slowest shutter speed available when using the flash, see Custom Setting e2 (**Flash shutter speed**, [□ 331](#)). For information on flash control and using the built-in flash in commander mode, see Custom Setting e3 (**Flash cntrl for built-in flash**, [□ 331](#)).

See page 428 for information on using optional flash units.

Aperture, Sensitivity, and Flash Range

Flash range varies with sensitivity (ISO equivalency) and aperture.

Maximum aperture at ISO equivalent of									Range	
64	100	200	400	800	1600	3200	6400	12800	m	ft
—	1.4	2	2.8	4	5.6	8	11	16	0.7–8.5	2ft 4in.–27ft 10in.
1.6	2	2.8	4	5.6	8	11	16	22	0.6–6.0	2ft–19ft 8in.
2.2	2.8	4	5.6	8	11	16	22	32	0.6–4.2	2ft–13ft 9in.
3.2	4	5.6	8	11	16	22	32	—	0.6–3.0	2ft–9ft 10in.
4.5	5.6	8	11	16	22	32	—	—	0.6–2.1	2ft–6ft 10in.
6.3	8	11	16	22	32	—	—	—	0.6–1.5	2ft–4ft 11in.
9	11	16	22	32	—	—	—	—	0.6–1.1	2ft–3ft 7in.
13	16	22	32	—	—	—	—	—	0.6–0.8	2ft–2ft 7in.

The built-in flash has a minimum range of 0.6 m (2 ft).

In exposure mode **P**, the maximum aperture (minimum f-number) is limited according to ISO sensitivity, as shown below:

Maximum aperture at ISO equivalent of:									
64	100	200	400	800	1600	3200	6400	12800	
2.5	2.8	3.5	4	5	5.6	7.1	8	10	

If the maximum aperture of the lens is smaller than given above, the maximum value for aperture will be the maximum aperture of the lens.

Flash Compensation

Flash compensation is used to alter flash output by from -3 EV to $+1$ EV in increments of $\frac{1}{3}$ EV, changing the brightness of the main subject relative to the background. Flash output can be increased to make the main subject appear brighter, or reduced to prevent unwanted highlights or reflections.

To choose a value for flash compensation, press the **⚡ (FL)** button and rotate the sub-command dial until the desired value is displayed in the control panel. In general, choose positive values to make the main subject brighter, negative values to make it darker.

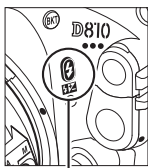

⚡ (FL) button

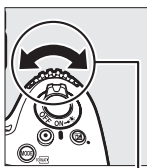

Sub-command dial

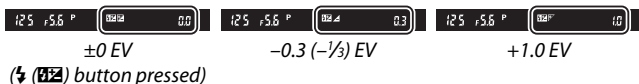
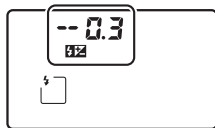



At values other than ± 0.0 , a **FL** icon will be displayed in the control panel and viewfinder after you release the **⚡ (FL)** button. The current value for flash compensation can be confirmed by pressing the **⚡ (FL)** button.

Normal flash output can be restored by setting flash compensation to ± 0.0 . Flash compensation is not reset when the camera is turned off.

Optional Flash Units

The flash compensation selected with the optional flash unit is added to the flash compensation selected with the camera.

See Also

For information on choosing the size of the increments available for flash compensation, see Custom Setting b3 (**Exp./flash comp. step value**,  315). For information on choosing how flash and exposure compensation combine, see Custom Setting e4 (**Exposure comp. for flash**,  338). For information on automatically varying flash level over a series of shots, see page 133.

FV Lock

This feature is used to lock flash output, allowing photographs to be recomposed without changing the flash level and ensuring that flash output is appropriate to the subject even when the subject is not positioned in the center of the frame. Flash output is adjusted automatically for any changes in ISO sensitivity and aperture.

To use FV lock:

- 1 Assign FV lock to a camera control.**
Select **FV lock** as the “press” option for Custom Setting f4 (**Assign Fn button**, [p 343](#)), f5 (**Assign preview button**, [p 349](#)), or f6 (**Assign AE-L/AF-L button**, [p 349](#)).

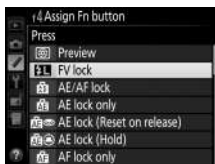

- 2 Press the flash pop-up button.**
The built-in flash will pop up and begin charging.

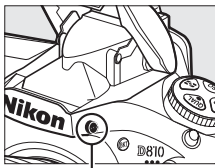

Flash pop-up button

- 3 Focus.**
Position the subject in the center of the frame and press the shutter-release button halfway to focus.



4 Lock flash level.

After confirming that the flash ready indicator (🔦) is displayed in the viewfinder, press the button selected in Step 1. The flash will emit a monitor preflash to determine the appropriate flash level. Flash output will be locked at this level and FV lock icon (🔒) will appear in the viewfinder.



5 Recompose the photograph.



6 Take the photograph.

Press the shutter-release button the rest of the way down to shoot. If desired, additional pictures can be taken without releasing FV lock.

7 Release FV lock.

Press the button selected in Step 1 to release FV lock. Confirm that the FV lock icon (🔒) is no longer displayed in the viewfinder.

Using FV Lock with the Built-in Flash

FV lock is only available with the built-in flash when **TTL** is selected for Custom Setting e3 (**Flash cntrl for built-in flash**,  331).

Using FV Lock with Optional Flash Units

FV lock is also available with optional flash units in TTL and (where supported) monitor pre-flash AA and monitor pre-flash A flash control modes. Note that when commander mode is selected for Custom Setting e3 (**Flash cntrl for built-in flash**,  331), you will need to set the flash control mode for the master or at least one remote group to TTL or AA.

Metering

The metering areas for FV lock when using optional flash unit are as follows:

Flash unit	Flash mode	Metered area
Stand-alone flash unit	i-TTL	6-mm circle in center of frame
	AA	Area metered by flash exposure meter
Used with other flash units (Advanced Wireless Lighting)	i-TTL	Entire frame
	AA	Area metered by flash exposure meter
	A (master flash)	

Other Shooting Options

The **Info** Button (Viewfinder Photography)

Pressing the **Info** button during viewfinder photography displays shooting information in the monitor including shutter speed, aperture, number of exposures remaining, and AF-area mode.

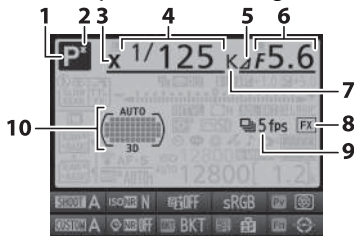

1	Exposure mode	116	6	Aperture (f-number)	120, 121
2	Flexible program indicator	118		Aperture (number of stops)	120, 424
3	Flash sync indicator	329		Bracketing increment	135, 140
4	Shutter speed	119, 121		Number of shots in ADL bracketing sequence	143
	White balance fine-tuning	151		Maximum aperture (non-CPU lenses)	232
	Color temperature	148, 155	7	Color temperature indicator	148, 155, 157
	Number of shots in exposure and flash bracketing sequence	134	8	Image area indicator	74
	Number of shots in WB bracketing sequence	139	9	Release mode indicator	102
	Number of shots in multiple exposure	211		Continuous shooting speed	104
	Focal length (non-CPU lenses)	232	10	Focus points indicator	94
5	Aperture stop indicator	120, 424		AF-area mode indicator	90

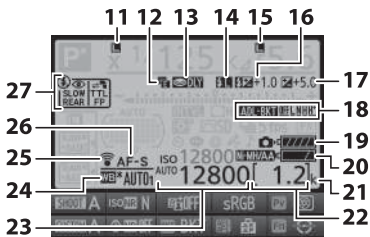

11	Shutter-speed lock icon	126	19	Camera battery indicator	19
12	Electronic front-curtain shutter indicator	323	20	MB-D12 battery type display.....	327
13	Exposure delay mode indicator	322	21	MB-D12 battery indicator.....	328
14	FV lock indicator	199	21	"k" (appears when memory remains for over 1000 exposures)	20
15	Aperture lock icon.....	127	22	Number of exposures remaining.....	20, 489
	HDR (series) indicator	188		Manual lens number	232
	Multiple exposure (series) indicator	211		Time-lapse recording indicator	223, 227
16	Flash compensation indicator	196	23	ISO sensitivity indicator	109
	Flash compensation value.....	196		Auto ISO sensitivity indicator	111
17	Exposure compensation indicator	130	24	White balance	148
	Exposure compensation value	130		White balance fine-tuning indicator	152
18	Exposure and flash bracketing indicator	134	25	Eye-Fi connection indicator	382
	WB bracketing indicator	139	26	Autofocus mode indicator	87
	ADL bracketing indicator.....	143	27	Flash mode	191
	ADL bracketing amount	144			
	HDR indicator	185			
	HDR exposure differential	188			
	Multiple exposure indicator.....	210			

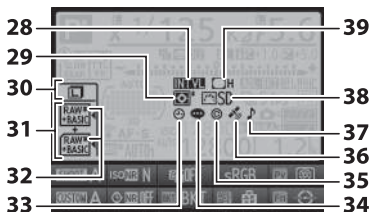

<p>28 Interval timer indicator 216, 219</p> <p>29 Time-lapse indicator 223, 227</p> <p>30 Metering 114</p> <p>31 Image size (JPEG and TIFF images) 83</p> <p>32 Image quality 79</p> <p>33 Secondary slot function 86</p> <p>34 Small image size indicator (NEF/RAW images) 85</p>	<p>35 ☺ indicator 466</p> <p>36 Image comment indicator 375</p> <p>37 Copyright information indicator 376</p> <p>38 Satellite signal indicator 233</p> <p>39 "Beep" indicator 321</p> <p>40 Picture Control indicator 172</p> <p>41 Vignette control indicator 297</p>
---	--

The ☺ Indicator

The camera clock is powered by an independent, rechargeable power source, which is charged as necessary when the main battery is installed or the camera is powered by an optional power connector and AC adapter (□ 436). Two days of charging will power the clock for about three months. If the ☺ icon flashes in the information display, the clock has been reset and the date and time recorded with any new photographs will not be correct. Set the clock to the correct time and date using the **Time zone and date > Date and time** option in the setup menu (□ 18).

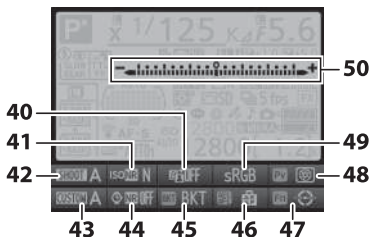



<table border="0"> <tr><td>40</td><td>Active D-Lighting indicator</td><td>183</td></tr> <tr><td>41</td><td>High ISO noise reduction indicator.....</td><td>299</td></tr> <tr><td>42</td><td>Shooting menu bank</td><td>291</td></tr> <tr><td>43</td><td>Custom settings bank.....</td><td>304</td></tr> <tr><td>44</td><td>Long exposure noise reduction indicator.....</td><td>299</td></tr> <tr><td>45</td><td>BKT button assignment</td><td>350</td></tr> <tr><td>46</td><td>AE-L/AF-L button assignment.....</td><td>349</td></tr> <tr><td>47</td><td>Fn button assignment.....</td><td>343</td></tr> </table>	40	Active D-Lighting indicator	183	41	High ISO noise reduction indicator.....	299	42	Shooting menu bank	291	43	Custom settings bank.....	304	44	Long exposure noise reduction indicator.....	299	45	BKT button assignment	350	46	AE-L/AF-L button assignment.....	349	47	Fn button assignment.....	343	<table border="0"> <tr><td>48</td><td>Pv button assignment</td><td>349</td></tr> <tr><td>49</td><td>Color space indicator</td><td>296</td></tr> <tr><td>50</td><td>Exposure indicator</td><td>122</td></tr> <tr><td></td><td>Exposure compensation indicator</td><td>130</td></tr> <tr><td></td><td>Bracketing progress indicator: Exposure and flash bracketing.....</td><td>134</td></tr> <tr><td></td><td>WB bracketing.....</td><td>139</td></tr> <tr><td></td><td>ADL bracketing</td><td>143</td></tr> </table>	48	Pv button assignment	349	49	Color space indicator	296	50	Exposure indicator	122		Exposure compensation indicator	130		Bracketing progress indicator: Exposure and flash bracketing.....	134		WB bracketing.....	139		ADL bracketing	143
40	Active D-Lighting indicator	183																																												
41	High ISO noise reduction indicator.....	299																																												
42	Shooting menu bank	291																																												
43	Custom settings bank.....	304																																												
44	Long exposure noise reduction indicator.....	299																																												
45	BKT button assignment	350																																												
46	AE-L/AF-L button assignment.....	349																																												
47	Fn button assignment.....	343																																												
48	Pv button assignment	349																																												
49	Color space indicator	296																																												
50	Exposure indicator	122																																												
	Exposure compensation indicator	130																																												
	Bracketing progress indicator: Exposure and flash bracketing.....	134																																												
	WB bracketing.....	139																																												
	ADL bracketing	143																																												

Note: Display shown with all indicators lit for illustrative purposes.

Turning the Monitor Off

To clear shooting information from the monitor, press the **Info** button again or press the shutter-release button halfway. The monitor will turn off automatically if no operations are performed for about 10 seconds.

See Also

For information on choosing how long the monitor stays on, see Custom Setting c4 (**Monitor off delay**,  320). For information on changing the color of the lettering in the information display, see Custom Setting d10 (**Information display**,  326).

The *i* button

Press the *i* button for quick access to the following settings during viewfinder photography. Highlight items using the multi selector and press **OK** to view options for the highlighted item. Press the *i* button again to resume shooting.

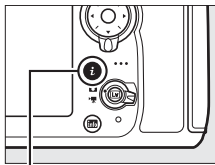

i button



Option	
Shooting menu bank	291
High ISO NR	299
Active D-Lighting	183
Color space	296
Assign preview button	349

Option	
Assign Fn button	343
Assign AE-L/AF-L button	349
Assign BKT button	350
Long exposure NR	299
Custom settings bank	304

Tool Tips

A tool tip giving the name of the selected item appears in the information display. Tool tips can be turned off using Custom Setting d9 (**Screen tips**; 325).



Two-Button Reset: Restoring Default Settings

The camera settings listed below can be restored to default values by holding the **QUAL** and  buttons down together for more than two seconds (these buttons are marked by a green dot). The control panel turns off briefly while settings are reset.

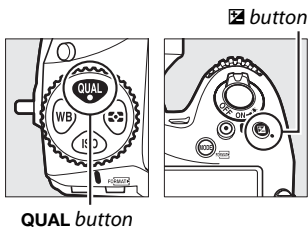



■ ■ Settings Accessible from the Shooting Menu¹

Option	Default
Image quality	JPEG normal
JPEG/TIFF recording	
Image size	Large
NEF (RAW) recording	
Image size	Large
White balance	Auto > Normal
Fine-tuning	A-B: 0, G-M: 0
Picture Control settings ²	Unmodified
HDR (high dynamic range)	Off ³
ISO sensitivity settings	
ISO sensitivity	100
Auto ISO sensitivity control	Off
Multiple exposure	Off ⁴
Interval timer shooting	Off ⁵

- 1 With the exception of multiple exposure and interval timer settings and Picture Control parameters, only settings in the bank currently selected using the **Shooting menu bank** option will be reset (☐ 291). Settings in the remaining banks are unaffected.
- 2 Current Picture Control only.
- 3 Exposure differential and smoothing are not reset.
- 4 If multiple exposure is currently in progress, shooting will end and multiple exposure will be created from exposures recorded to that point. Gain and number of shots are not reset.
- 5 If interval timer shooting is currently in progress, shooting will end. Starting time, shooting interval, number of intervals and shots, and exposure smoothing are not reset.

■ Other Settings

Option	Default
Focus point ¹	Center
Preset focus point	Center
Exposure mode	Programmed auto
Flexible program	Off
Exposure compensation	Off
AE lock hold	Off
Aperture lock	Off
Shutter speed lock	Off
Autofocus mode	AF-S
AF-area mode	
Viewfinder	Single-point AF
Live view photography/movie live view	Normal-area AF
Photo live view display WB	None
Highlight display	Off
Headphone volume	15
Metering	Matrix
Bracketing	Off ²
Flash mode	Front-curtain sync
Flash compensation	Off
FV lock	Off
Exposure delay mode	Off ³
+ NEF (RAW)	Off

- 1 Focus point not displayed if auto-area AF is selected for AF-area mode.
- 2 Number of shots is reset to zero. Bracketing increment is reset to 1EV (exposure/flash bracketing) or 1 (white balance bracketing).  **A Auto** is selected for the second shot of two-shot ADL bracketing programs.
- 3 Only settings in the bank currently selected using the **Custom settings bank** option will be reset ( 304). Settings in the remaining banks are unaffected.

See Also

See page 272 for a list of default settings.

Multiple Exposure

Follow the steps below to record a series of two to ten exposures in a single photograph. Multiple exposures can make use of RAW data from the camera image sensor to produce colors noticeably superior to those in software-generated photographic overlays.

■ Creating a Multiple Exposure

Multiple exposures can not be recorded in live view. Exit live view before proceeding. Note that at default settings, shooting will end and a multiple exposure will be recorded automatically if no operations are performed for 30 s.

1 Select Multiple exposure.

Highlight **Multiple exposure** in the shooting menu and press .





✎ Extended Recording Times

For an interval between exposures of more than 30 s, extend the meter-off delay using Custom Setting c2 (**Standby timer**,  319). The maximum interval between exposures is 30 s longer than the option selected for Custom Setting c2. If the monitor turns off during playback or menu operations and no operations are performed for 30 s after the standby timer has expired, shooting will end and a multiple exposure will be created from the exposures that have been recorded to that point.

2 Select a mode.

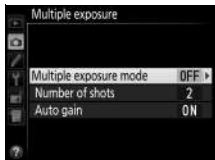
Highlight **Multiple exposure mode** and press .



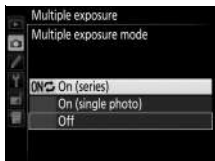

Highlight one of the following and press :

- **To take a series of multiple exposures, select ON  On (series).** Multiple exposure shooting will continue until you select **Off** for **Multiple exposure mode**.
- **To take one multiple exposure, select On (single photo).** Normal shooting will resume automatically after you have created a single multiple exposure.
- **To exit without creating additional multiple exposures, select Off.**



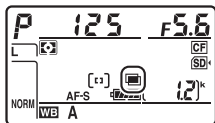

If **On (series)** or **On (single photo)** is selected, a  icon will be displayed in the control panel.



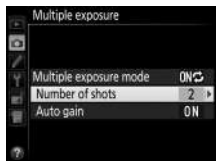



- 3 Choose the number of shots.**
Highlight **Number of shots** and press .

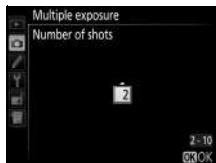

Press  or  to choose the number of exposures that will be combined to form a single photograph and press .





The BKT Button

If **Multiple exposure** is selected for Custom Setting f8 (**Assign BKT button;**  350), you can select the multiple exposure mode by pressing the **BKT** button and rotating the main command dial and the number of shots by pressing the **BKT** button and rotating the sub-command dial. The mode and number of shots are shown in the control panel:  and  appear when **On (series)** is selected and  when **On (single photo)** is selected; no icon appears when multiple exposure is off.

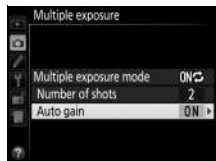

- 4 Choose the amount of gain.**
Highlight **Auto gain** and press .



The following options will be displayed. Highlight an option and press .

- **On:** Gain is adjusted according to number of exposures actually recorded (gain for each exposure is set to $\frac{1}{2}$ for 2 exposures, $\frac{1}{3}$ for 3 exposures, etc.).
- **Off:** Gain is not adjusted when recording multiple exposure. Note that photographs may be affected by noise (randomly-spaced bright pixels, fog, or lines).

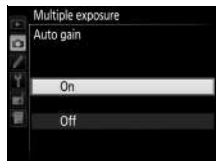



5 Frame a photograph, focus, and shoot.

In continuous release modes (☐ 102), the camera records all exposures in a single burst. If **On (series)** is selected, the camera will continue to record multiple exposures while the shutter-release button is pressed; if **On (single photo)** is selected, multiple exposure shooting will end after the first photograph. In self-timer mode, the camera will automatically record the number of exposures selected in Step 3 on page 211, regardless of the option selected for Custom Setting c3 (**Self-timer**) > **Number of shots** (☐ 319); the interval between shots is however controlled by Custom Setting c3 (**Self-timer**) > **Interval between shots**. In other release modes, one photograph will be taken each time the shutter-release button is pressed; continue shooting until all exposures have been recorded (for information on interrupting a multiple exposure before all photographs are recorded, see page 214).

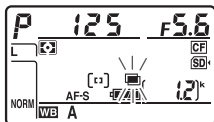

The  icon will flash until shooting ends. If **On (series)** is selected, multiple exposure shooting will only end when **Off** is selected for multiple exposure mode; if **On (single photo)**



is selected, multiple exposure shooting ends automatically when the multiple exposure is complete. The  icon clears from the display when multiple exposure shooting ends.

■ Interrupting Multiple Exposures

To interrupt a multiple exposure before the specified number of exposures have been taken, select **Off** for multiple exposure mode. If shooting ends before the specified number of exposures have been taken, a multiple exposure will be created from the exposures that have been recorded to that point. If **Auto gain** is on, gain will be adjusted to reflect the number of exposures actually recorded. Note that shooting will end automatically if:

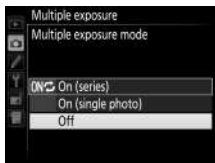

- A two-button reset is performed (☐ 206)
- The camera is turned off
- The battery is exhausted
- Pictures are deleted

✓ Multiple Exposure

Do not remove or replace the memory card while recording a multiple exposure.

Multiple exposures can not be recorded in live view. Taking photographs in live view resets **Multiple exposure mode** to **Off**.

The shooting information listed in the playback photo information display (including metering, exposure, exposure mode, focal length, date of recording and camera orientation) is for the first shot in the multiple exposure.

Interval Timer Photography

If interval timer photography is activated before the first exposure is taken, the camera will record exposures at the selected interval until the number of exposures specified in the multiple exposure menu have been taken (the number of shots listed in the interval timer shooting menu is ignored). These exposures will then be recorded as a single photograph and interval timer shooting will end (if **On (single photo)** is selected for multiple exposure mode, multiple exposure shooting will also end automatically).

Other Settings

While a multiple exposure is being shot, memory cards can not be formatted and some menu items are grayed out and can not be changed.

Interval Timer Photography

The camera is equipped to take photographs automatically at preset intervals.

✔ Before Shooting

Select a release mode other than self-timer (☺) when using the interval timer. Before beginning interval timer photography, take a test shot at current settings and view the results in the monitor. Once settings have been adjusted to your satisfaction, close the viewfinder eyepiece shutter to prevent light entering via the viewfinder interfering with photographs and exposure (📖 106).

Before choosing a starting time, select **Time zone and date** in the setup menu and make sure that the camera clock is set to the correct time and date (📖 18).

Use of a tripod is recommended. Mount the camera on a tripod before shooting begins. To ensure that shooting is not interrupted, be sure the camera battery is fully charged. If in doubt, charge the battery before use or use an AC adapter and power connector (available separately).

- 1 Select Interval timer shooting.**
Highlight **Interval timer shooting** in the shooting menu and press **▶** to display interval timer settings.



2 Adjust interval timer settings.

Choose a start option, interval, number of shots per interval, and exposure smoothing option.

- **To choose a start option:**



Highlight **Start options** and press .

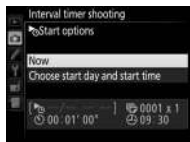

Highlight an option and press .

To start shooting immediately, select **Now**. To start shooting at a chosen date and time, select **Choose start day and start time**, then choose the date and time and press .

- **To choose the interval between shots:**



Highlight **Interval** and press .



Choose an interval (hours, minutes, and seconds) and press .

- To choose the number of shots per interval:



Highlight **No. of intervals × shots/interval** and press \odot .



Choose the number of intervals and the number of shots per interval and press \odot .

In **S** (single frame) mode, the photographs for each interval will be taken at the rate chosen for Custom Setting d2 (**CL mode shooting speed**, \square 321).

- To enable or disable exposure smoothing:



Highlight **Exposure smoothing** and press \odot .



Highlight an option and press \odot .

Selecting **On** allows the camera to adjust exposure to match the previous shot in **P**, **S**, and **A** modes (note that exposure smoothing only takes effect in mode **M** if auto ISO sensitivity control is on).

3 Start shooting.

Highlight **Start** and press **OK**. The first series of shots will be taken at the specified starting time, or after about 3 s if **Now** was selected for **Start options** in Step 2. Shooting will continue at the selected interval until all shots have been taken.

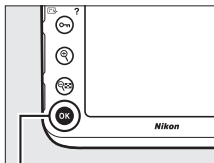

OK button



During Shooting

During interval timer photography, the **INTVL** icon will flash in the control panel.

Immediately before the next shooting interval begins, the shutter speed display will show the number of intervals remaining, and the aperture display will

show the number of shots remaining in the current interval. At other times, the number of intervals remaining and the number of shots in each interval can be viewed by pressing the shutter-release button halfway (once the button is released, the shutter speed and aperture will be displayed until the standby timer expires).

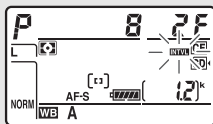

Pictures can be played back while interval timer photography is in progress. The monitor will turn off automatically about four seconds before each interval. Note that changing camera settings while the interval timer is active may cause shooting to end.

■ Pausing Interval Timer Photography

Interval timer photography can be paused between intervals by pressing **OK** or selecting **Pause** in the interval timer menu.

■ Resuming Interval Timer Shooting

To resume shooting:

Starting Now



Highlight **Restart** and press **OK**.

Starting at a Specified Time

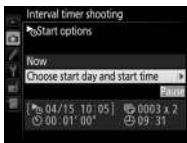

For **Start options**, highlight **Choose start day and start time** and press **OK**.

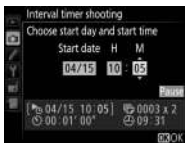

Choose a starting date and time and press **OK**.

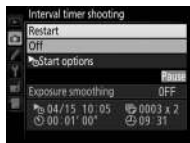

Highlight **Restart** and press **OK**.

■ Ending Interval Timer Shooting

To end interval timer photography and resume normal shooting before all the photos are taken, select **Off** in the interval timer menu.

■ ■ **No Photograph**

The camera will skip the current interval if any of the following situations persist for eight seconds or more after the interval was due to start: the photograph or photographs for the previous interval have yet to be taken, the memory card is full, or single-servo autofocus is in effect and the camera is unable to focus (note that the camera focuses again before each shot). Shooting will resume with the next interval.

☑ **Out of Memory**

If the memory card is full, the interval timer will remain active but no pictures will be taken. Resume shooting (☐ 220) after deleting some pictures or turning the camera off and inserting another memory card.

☑ **Interval Timer Photography**

Choose an interval longer than the time needed to take the selected number of shots. If the interval is too short, the number of photos taken may be less than the total listed in Step 2 (the number of intervals multiplied by the number of shots per interval). Interval timer photography can not be combined with long time-exposures (bulb or time photography, ☐ 123) or live view or time-lapse photography (☐ 35, 223) and is not available in movie live view (☐ 49) or when **Record movies** is selected for Custom Setting g4 (**Assign shutter button**, ☐ 364). Note that because the shutter speed, frame rate, and time needed to record images may vary from one interval to the next, the time between the end of one interval and the beginning of the next may vary. If shooting can not proceed at current settings (for example, if a shutter speed of $\frac{1}{200}$ or $\frac{1}{30}$ is currently selected in manual exposure mode or the start time is in less than a minute), a warning will be displayed in the monitor.

Interval timer shooting will pause when ⏸ (self-timer) mode is selected or if the camera is turned off and then on again (when the camera is off, batteries and memory cards can be replaced without ending interval timer photography). Pausing shooting does not affect interval timer settings.

Bracketing

Adjust bracketing settings before starting interval timer photography. If exposure, flash, or ADL bracketing is active while interval timer photography is in effect, the camera will take the number of shots in the bracketing program at each interval, regardless of the number of shots specified in the interval timer menu. If white balance bracketing is active while interval timer photography is in effect, the camera will take one shot at each interval and process it to create the number of copies specified in the bracketing program.

Shooting Menu Banks

Changes to interval timer settings apply to all shooting menu banks (☐ 291); changing the shooting menu bank does not interrupt interval timer photography. If shooting menu settings are reset using the **Shooting menu bank** item in the shooting menu (☐ 292), interval timer shooting will end and interval timer settings will be reset as follows:

- Start options: Now
- Interval: 00:01':00"
- Number of intervals: 1
- Number of shots: 1
- Exposure smoothing: Off

Time-Lapse Photography

The camera automatically takes photos at selected intervals to create a silent time-lapse movie using the options currently selected for **Frame size/frame rate**, **Movie quality**, and **Destination** in the movie settings menu (📖 62). For information on the image area used for time-lapse movies, see page 59.

🔍 Before Shooting

Before beginning time-lapse photography, take a test shot at current settings (framing the photo in the viewfinder for an accurate exposure preview) and view the results in the monitor. For consistent coloration, choose a white balance setting other than auto (📖 148). Once settings have been adjusted to your satisfaction, close the viewfinder eyepiece shutter to prevent light entering via the viewfinder interfering with photographs and exposure (📖 106).

Use of a tripod is recommended. Mount the camera on a tripod before shooting begins. To ensure that shooting is not interrupted, use an optional AC adapter and power connector or a fully-charged battery.

- 1 Select Time-lapse photography.** Highlight **Time-lapse photography** in the shooting menu and press **⏏** to display time-lapse photography settings.



2 Adjust time-lapse photography settings.

Choose an interval, total shooting time, and exposure smoothing option.

- To choose the interval between frames:



Highlight **Interval** and press \odot .



Choose an interval longer than the slowest anticipated shutter speed (minutes and seconds) and press \odot .

- To choose the total shooting time:



Highlight **Shooting time** and press \odot .



Choose shooting time (up to 7 hours 59 minutes) and press \odot .

- To enable or disable exposure smoothing:



Highlight **Exposure smoothing** and press \odot .



Highlight an option and press \odot .

Selecting **On** smooths abrupt changes in exposure in **P**, **S**, and **A** modes (note that exposure smoothing only takes effect in mode **M** if auto ISO sensitivity control is on).

3 Start shooting.

Highlight **Start** and press **OK**. Time-lapse photography starts after about 3 s. The camera takes photographs at the selected interval for the selected shooting time.

When complete, time-lapse movies are recorded to the memory card selected for **Movie settings > Destination** (□ 63).

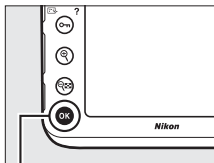

OK button



Ending Time-Lapse Photography

To end time-lapse photography before all the photos are taken, highlight **Off** in the time-lapse photography menu and press **OK**, or press **OK** between frames or immediately after a frame is recorded. A movie will be created from the frames shot to the point where time-lapse photography ended. Note that time-lapse photography will end and no movie will be recorded if the power source is removed or disconnected or the destination memory card is ejected.

■ No Photograph

The camera will skip the current frame if single-servo autofocus is in effect and the camera is unable to focus (note that the camera focuses again before each shot). Shooting will resume with the next frame.

✓ Time-Lapse Photography

Time-lapse is not available in live view (☐ 35, 49), at a shutter speed of **b u L b** or - - (☐ 123), when bracketing (☐ 133), High Dynamic Range (HDR, ☐ 184), multiple exposure (☐ 209), or interval timer photography (☐ 216) is active. Note that because shutter speed and the time needed to record the image to the memory card may vary from shot to shot, the interval between a shot being recorded and the start of the next shot may vary. Shooting will not begin if a time-lapse movie can not be recorded at current settings (for example, if the memory card is full, the interval or shooting time is zero, or the interval is longer than the shooting time).

Time-lapse photography may end if camera controls are used or settings are changed or HDMI cable is connected. A movie will be created from the frames shot to the point where time-lapse photography ended.

Calculating the Length of the Final Movie

The total number of frames in the final movie can be approximated by dividing the shooting time by the interval and rounding up. The length of the final movie can then be calculated by dividing the number of shots by the frame rate selected for **Movie settings > Frame size/frame rate**. A 48 frame movie recorded at **1920x1080; 24p**, for example, will be about two seconds long. The maximum length for movies recorded using time-lapse photography is 20 minutes.

During Shooting

During time-lapse photography, a **INTVL** icon will flash and the time-lapse recording indicator will be displayed in the control panel. The time remaining (in hours and minutes) appears in the shutter-speed display immediately before each frame is recorded. At other times, the time remaining can be viewed by pressing the shutter-release button halfway. Regardless of the option selected for Custom Setting c2 (**Standby timer**, [☰ 319](#)), the standby timer will not expire during shooting.

To view current time-lapse photography settings or end time-lapse photography ([☰ 220](#)), press the **MENU** button between shots.

*Length recorded/
maximum length*

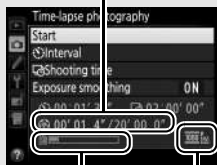

*Memory card
indicator*

Frame size/frame rate

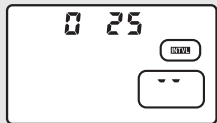





Image Review

The  button can not be used to view pictures while time-lapse photography is in progress, but the current frame will be displayed for a few seconds after each shot if **On** is selected for **Image review** in the playback menu ( 287). Other playback operations can not be performed while the frame is displayed.

Release Mode

Regardless of the release mode selected, the camera will take one shot at each interval. The self-timer can not be used.

See Also

For information on setting a beep to sound when time-lapse photography is complete, see Custom Setting d1 (**Beep**,  321).

Non-CPU Lenses

Non-CPU lenses can be used in exposure modes **A** and **M**, with aperture set using the lens aperture ring. By specifying lens data (lens focal length and maximum aperture), the user can gain access to the following CPU lens functions.

If the focal length of the lens is known:

- Power zoom can be used with optional flash units
- Lens focal length is listed (with an asterisk) in the playback photo info display

If the maximum aperture of the lens is known:

- The aperture value is displayed in the control panel and viewfinder
- Flash level is adjusted for changes in aperture if the flash unit supports AA (auto aperture) mode
- Aperture is listed (with an asterisk) in the playback photo info display

Specifying both the focal length and maximum aperture of the lens:

- Enables color matrix metering (note that it may be necessary to use center-weighted or spot metering to achieve accurate results with some lenses, including Reflex-NIKKOR lenses)
- Improves the precision of center-weighted and spot metering and i-TTL balanced fill-flash for digital SLR

The camera can store data for up to nine non-CPU lenses. To enter or edit data for a non-CPU lens:

1 Select Non-CPU lens data.

Highlight **Non-CPU lens data** in the setup menu and press **▶**.



2 Choose a lens number.

Highlight **Lens number** and press **◀** or **▶** to choose a lens number.

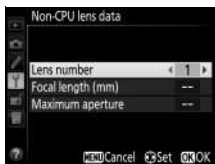

3 Enter the focal length and aperture.

Highlight **Focal length (mm)** or **Maximum aperture** and press **◀** or **▶** to edit the highlighted item.

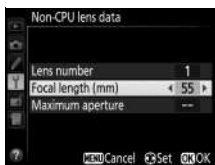

4 Save settings and exit.

Press **OK**. The specified focal length and aperture will be stored under the chosen lens number.

Focal Length Not Listed

If the correct focal length is not listed, choose the closest value greater than the actual focal length of the lens.

Teleconverters and Zoom Lenses

The maximum aperture for teleconverters is the combined maximum aperture of the teleconverter and the lens. Note that lens data are not adjusted when non-CPU lenses are zoomed in or out. The data for different focal lengths can be entered as separate lens numbers, or the data for the lens can be edited to reflect the new values for lens focal length and maximum aperture each time zoom is adjusted.

To recall lens data when using a non-CPU lens:

1 Assign non-CPU lens number selection to a camera control.

Select **Choose non-CPU lens number** as the “Press + command dials” option for a camera control in the Custom Settings menu (☞ 348). Non-CPU lens number selection can be assigned to the **Fn** button (Custom Setting f4, **Assign Fn button**, ☞ 343), the **Pv** button (Custom Setting f5, **Assign preview button**, ☞ 349), or the **AE-L/AF-L** button (Custom Setting f6, **Assign AE-L/AF-L button**, ☞ 349).

2 Use the selected control to choose a lens number.

Press the selected button and rotate the main or sub-command dial until the desired lens number is displayed in the control panel.

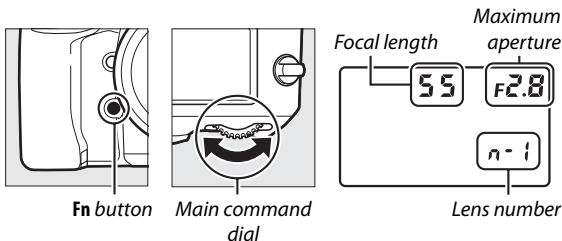

Location Data

A GPS unit can be connected to the ten-pin remote terminal, allowing the current latitude, longitude, altitude, Coordinated Universal Time (UTC), and heading to be recorded with each photograph taken. The camera can be used with an optional GP-1 and GP-1A GPS units (see below; note that these units do not provide the compass heading), or with compatible third-party units connected via an optional MC-35 GPS adapter cord (☞ 440).

■ GP-1/GP-1A GPS Units

These optional GPS units are designed for use with Nikon digital cameras. For information on connecting the unit, see the manual provided with the device.

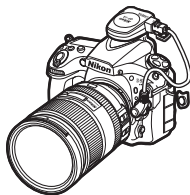

🔍 The 📶 Icon

Connection status is shown by the 📶 icon:

- 📶 (static): The camera has established communication with the GPS device. Photo information for pictures taken while this icon is displayed includes an additional page of location data (☞ 246).
- 📶 (flashing): The location device is searching for a signal. Pictures taken while the icon is flashing do not include location data.
- No icon: No new location data have been received from the GPS device for at least two seconds. Pictures taken when the 📶 icon is not displayed do not include location data.

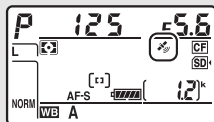

■ Setup Menu Options

The **Location data** item in the setup menu contains the options listed below.

- **Standby timer:** Choose whether or not the exposure meters will turn off automatically when a GPS unit is attached.

Option	Description
Enable	Exposure meters will turn off automatically if no operations are performed for the period specified in Custom Setting c2 (Standby timer , □ 319; to allow the camera time to acquire location data when a GP-1 or GP-1A is connected, the delay is extended by up to one minute after exposure meters are activated or the camera is turned on). This reduces the drain on the battery.
Disable	Exposure meters will not turn off while a GPS unit is connected.

- **Position:** This item is only available if a GPS device is connected, when it displays the current latitude, longitude, altitude, Coordinated Universal Time (UTC), and heading (if supported) as reported by the GPS device.
- **Set clock from satellite:** Select **Yes** to synchronize the camera clock with the time reported by the GPS device.

📏 Heading

The heading is only recorded if the GPS device is equipped with a digital compass (note that the GP-1 and GP-1A are not equipped with a compass). Keep the GPS device pointing in the same direction as the lens and at least 20cm (8 in.) from the camera.

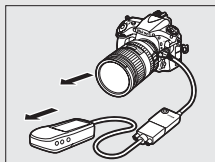

📏 Coordinated Universal Time (UTC)



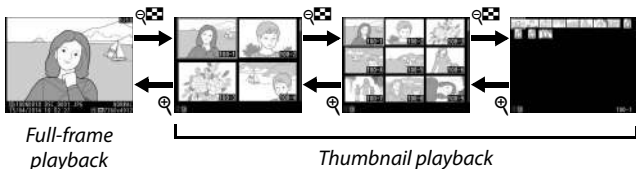

UTC data is provided by the GPS device and is independent of the camera clock.

More About Playback

Viewing Images



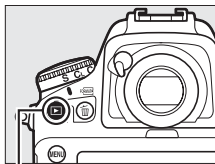

Full-Frame Playback

To play photographs back, press the  button. The most recent photograph will be displayed in the monitor. Additional pictures can be displayed by pressing  or ; to view additional information on the current photograph, press  or  (see 238).



 button

Thumbnail Playback

To view multiple images, press the  button when a picture is displayed full frame. The number of images displayed increases from 4 to 9 to 72 each time the  button is pressed, and decreases with each press of the  button. Use the multi selector to highlight images and press the center of the multi selector to view the highlighted image full frame.

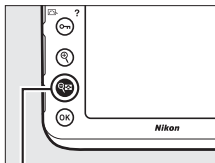

 button

Rotate Tall

To display “tall” (portrait-orientation) photographs in tall orientation, select **On** for the **Rotate tall** option in the playback menu (☞ 288).





Image Review

When **On** is selected for **Image review** in the playback menu (☞ 287), photographs are automatically displayed in the monitor after shooting (because the camera is already in the correct orientation, images are not rotated automatically during image review). In continuous release modes, display begins when shooting ends, with the first photograph in the current series displayed.

Retouch and Editing

To create a retouched or edited copy of the photo or movie currently displayed in full-frame playback, press the **i** button and choose an option.

✎ Two Memory Cards

If two memory cards are inserted, you can select a memory card for playback by pressing the  button when 72 thumbnails are displayed. The dialog shown at right will be displayed; highlight the desired slot and press  to display a list of folders, then highlight a folder and press  to view the pictures in the selected folder.



✎ Resuming Shooting

To turn the monitor off and return to shooting mode, press  or press the shutter-release button halfway. Photographs can be taken immediately.

✎ See Also



For information on choosing how long the monitor will remain on when no operations are performed, see Custom Setting c4 (**Monitor off delay**,  320). For information on choosing the role played by the center of the multi selector, see Custom Setting f2 (**Multi selector center button**,  341). For information on using the command dials for image or menu navigation, see Custom Setting f9 (**Customize command dials**) > **Menus and playback** ( 352).

Photo Information

Photo information is superimposed on images displayed in full-frame playback. Press or to cycle through photo information as shown below. Note that “image only”, shooting data, RGB histograms, and highlights are only displayed if corresponding option is selected for **Playback display options** (□ 282). Location data are only displayed if a GPS device was used when the photo was taken (□ 233).



File Information

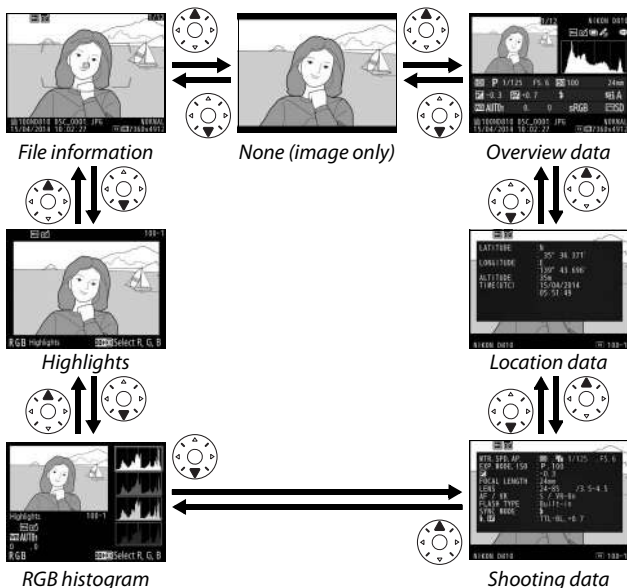
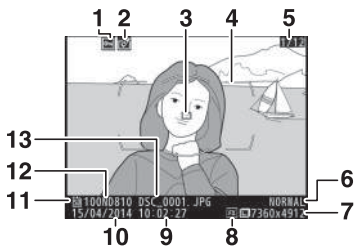

1	Protect status.....	250	7	Image size	83
2	Retouch indicator	384	8	Image area	74
3	Focus point ^{1,2}	94	9	Time of recording	18
4	AF area brackets ¹	17	10	Date of recording	18
5	Frame number/total number of frames		11	Current card slot	20
6	Image quality	79	12	Folder name.....	293
			13	File name	295

1 Displayed only if **Focus point** is selected for **Playback display options** (☐ 282).

2 If photograph was taken using **AF-S**, display shows point where focus first locked. If photograph was taken using **AF-C**, focus point is only displayed if option other than auto-area AF was selected for AF-area mode and camera was able to focus.

■ Highlights

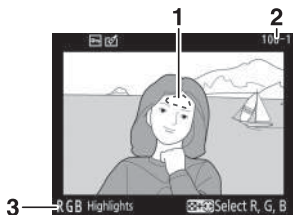

1 Image highlights *

3 Current channel *

2 Folder number–frame number

.....293

* Flashing areas indicate highlights (areas that may be overexposed) for current channel. Hold  and press  or  to cycle through channels as follows:

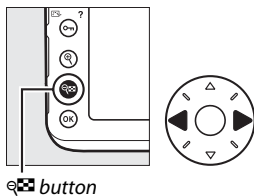

 button



RGB Histogram

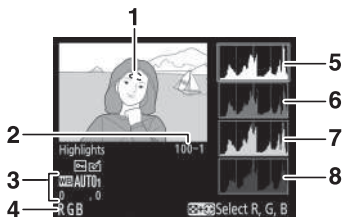

1	Image highlights *	4	Current channel *
2	Folder number–frame number 293	5	Histogram (RGB channel). In all histograms, horizontal axis gives pixel brightness, vertical axis number of pixels.
3	White balance 148 Color temperature 155 White balance fine-tuning 151	6	Histogram (red channel)
	Preset manual 158	7	Histogram (green channel)
		8	Histogram (blue channel)

* Flashing areas indicate highlights (areas that may be overexposed) for current channel. Hold button and press or to cycle through channels as follows:

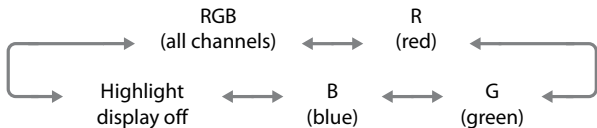
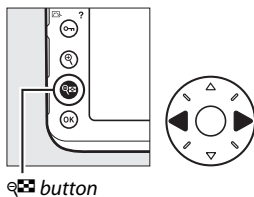

Playback Zoom

To zoom in on the photograph when the histogram is displayed, press \mathcal{Q} . Use the \mathcal{Q} and \mathcal{Q} buttons to zoom in and out and scroll the image with the multi selector. The histogram will be updated to show only the data for the portion of the image visible in the monitor.



Histograms

Camera histograms are intended as a guide only and may differ from those displayed in imaging applications. Some sample histograms are shown below:

If the image contains objects with a wide range of brightnesses, the distribution of tones will be relatively even.



If the image is dark, tone distribution will be shifted to the left.



If the image is bright, tone distribution will be shifted to the right.



Increasing exposure compensation shifts the distribution of tones to the right, while decreasing exposure compensation shifts the distribution to the left. Histograms can provide a rough idea of overall exposure when bright ambient lighting makes it difficult to see photographs in the monitor.

■ Shooting Data

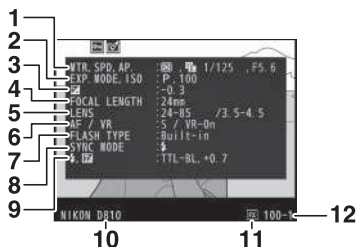

<p>1 Metering 114</p> <p>Electronic front-curtain shutter..... 323</p> <p>Shutter speed 119, 121</p> <p>Aperture..... 120, 121</p> <p>2 Exposure mode 116</p> <p>ISO sensitivity¹ 109</p> <p>3 Exposure compensation 130</p> <p>Optimal exposure tuning² 318</p> <p>4 Focal length 229, 427</p> <p>5 Lens data 229</p> <p>6 Focus mode.....87</p> <p>Lens VR (vibration reduction)³</p>	<p>7 Flash type 189, 428</p> <p>Commander mode..... 334</p> <p>8 Flash mode 191</p> <p>9 Flash control 331</p> <p>Flash compensation 196</p> <p>10 Camera name</p> <p>11 Image area74</p> <p>12 Folder number-frame number 293</p>
--	--



13	White balance..... 148	14	Color space..... 296
	Color temperature..... 155	15	Picture Control ⁴ 170
	White balance fine-tuning 151		
	Preset manual..... 158		

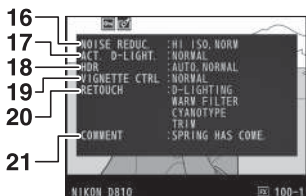

16	High ISO noise reduction..... 299	19	Vignette control..... 297
	Long exposure noise reduction 299	20	Retouch history..... 384
17	Active D-Lighting..... 182	21	Image comment 375
18	HDR exposure differential 186		
	HDR smoothing..... 186		



22 Name of photographer⁵ 376 **23** Copyright holder⁵ 376

- 1 Displayed in red if photo was taken with auto ISO sensitivity control on.
- 2 Displayed if Custom Setting b7 (**Fine-tune optimal exposure**,  318) has been set to a value other than zero for any metering method.
- 3 Displayed only if VR lens is attached.
- 4 Items displayed vary with Picture Control selected.
- 5 The fourth page of the shooting data is only displayed if copyright information was recorded with the photograph as described on page 376.

■■ Location Data¹ (☞ 233)

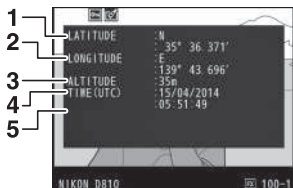

1 Latitude

2 Longitude

3 Altitude

4 Coordinated Universal Time (UTC)

5 Heading²

1 Data for movies are for start of recording.

2 Displayed only if GPS device is equipped with electronic compass.

Overview

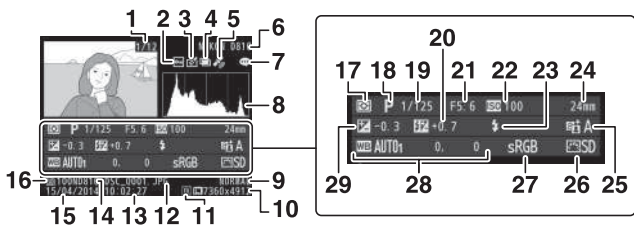

1 Frame number/total number of frames	17 Metering 114
2 Protect status..... 250	18 Exposure mode 116
3 Retouch indicator 384	19 Shutter speed 119, 121
4 Multiple exposure 209	20 Flash compensation 196
5 Location data indicator 233	Commander mode 334
6 Camera name	21 Aperture 120, 121
7 Image comment indicator 375	22 ISO sensitivity* 109
8 Histogram showing the distribution of tones in the image (☐ 242).	23 Flash mode 191
9 Image quality 79	24 Focal length 229, 427
10 Image size 83	25 Active D-Lighting 182
11 Image area 74	26 Picture Control 170
12 File name 295	27 Color space 296
13 Time of recording 18	28 White balance 148
14 Folder name 293	Color temperature 155
15 Date of recording 18	White balance fine-tuning 151
16 Current card slot 20	Preset manual 158
	29 Exposure compensation 130



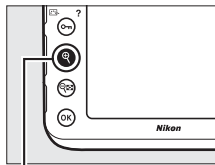

* Displayed in red if photo was taken with auto ISO sensitivity control on.

Taking a Closer Look: Playback Zoom





Press the  button to zoom in on the image displayed in full-frame playback. The following operations can be performed while zoom is in effect:



 button

To	Use	Description
Zoom in or out	 / 	Press  to zoom 36 × 24 (3 : 2) format images in to maximum of approximately 46× (large images), 34× (medium images) or 22× (small images). Press  to zoom out. While photo is zoomed in, use multi selector to view areas of image not visible in monitor. Keep multi selector pressed to scroll rapidly to other areas of frame. Navigation window is displayed when zoom ratio is altered; area currently visible in monitor is indicated by yellow border. Bar under navigation window shows zoom ratio; turns green at ratio of 1 : 1.
View other areas of image		

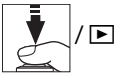

To	Use	Description
Select faces		<p>Faces (up to 35) detected during zoom are indicated by white borders in navigation window. Rotate sub-command dial to view other faces.</p> 
View other images		<p>Rotate main command dial to view same location in other images at current zoom ratio. Playback zoom is cancelled when a movie is displayed.</p>
Return to shooting mode		<p>Press the shutter-release button halfway or press the  button to exit to shooting mode.</p>

Protecting Photographs from Deletion

In full-frame, zoom, and thumbnail playback, press the **On** (🔒/?) button to protect the current picture from accidental deletion. Protected files are marked with a **On** icon and can not be deleted using the **🗑** (FORMAT) button or the **Delete** option in the playback menu. Note that protected images *will* be deleted when the memory card is formatted (📖 366). To remove protection from a picture so that it can be deleted, display or highlight it and press the **On** (🔒/?) button.

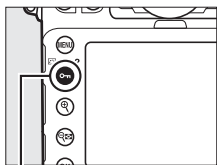

On (🔒/?) button



✎ Removing Protection from All Images

To remove protection from all images in the folder or folders currently selected in the **Playback folder** menu, press the **On** (🔒/?) and **🗑** (FORMAT) buttons together for about two seconds during playback.

Deleting Photographs

To delete the photograph displayed in full-frame playback or highlighted in the thumbnail list, press the  (FORMAT) button. To delete multiple selected photographs or all photographs in the current playback folder, use the **Delete** option in the playback menu. Once deleted, photographs can not be recovered. Note that pictures that are protected or hidden can not be deleted.

Full-Frame and Thumbnail Playback

Press the  (FORMAT) button to delete the current photograph.

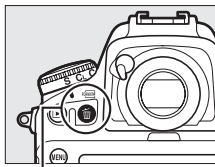

1 Press the (FORMAT) button.

A confirmation dialog will be displayed.



 (FORMAT) button

2 Press the (FORMAT) button again.

To delete the photograph, press the  (FORMAT) button. To exit without deleting the photograph, press the  button.

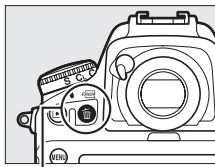

 (FORMAT) button

See Also

The **After delete** option in the playback menu determines whether the next image or the previous image is displayed after an image is deleted ( 287).

The Playback Menu

The **Delete** option in the playback menu contains the following options. Note that depending on the number of images, some time may be required for deletion.

Option	Description
 Selected	Delete selected pictures.
ALL All	Delete all pictures in the folder currently selected for playback (📁 281). If two cards are inserted, you can select the card from which pictures will be deleted.

■ Selected: Deleting Selected Photographs

1 Select pictures.

Use the multi selector to highlight a picture and press the center of the multi selector to select or deselect. Selected pictures are marked by a  icon. Repeat as desired to select additional pictures.



2 Delete the selected pictures.

Press **OK**. A confirmation dialog will be displayed; highlight **Yes** and press **OK**.



Connections

Installing ViewNX 2

Install the supplied software to display and edit photographs and movies that have been copied to your computer. Before installing ViewNX 2, confirm that your computer meets the system requirements on page 255. Be sure to use the latest version of ViewNX 2, which is available for download from the websites listed on page xxii, as earlier versions that do not support the D810 may fail to transfer NEF (RAW) images correctly.

1 Launch the installer.

Start the computer, insert the installer CD, and launch the installer. A language selection dialog will be displayed. If the desired language is not available, click **Region Selection** to choose a different region (region selection is not available in the European release).

① *Select region (if required)*



② *Select language*

③ *Click **Next***

2 Start the installer.

Click **Install** and follow the on-screen instructions.



Click **Install**

3 Exit the installer.

Windows



Click **Yes**

Mac



Click **OK**

4 Remove the installer CD from the CD-ROM drive.

Viewing the Nikon Website

To visit the Nikon website after installing ViewNX 2, select **All Programs > Link to Nikon** from the Windows start menu (Internet connection required).

System Requirements

Windows	
CPU	<ul style="list-style-type: none">• Photos: Intel Celeron, Pentium 4, or Core series, 1.6 GHz or better• Movies (playback): Pentium D 3.0 GHz or better; Intel Core i5 or better recommended when viewing movies with a frame size of 1280 × 720 or more at a frame rate of 30 fps or above or movies with a frame size of 1920 × 1080 or more• Movies (editing): Intel Core i5 or better
OS*	Pre-installed versions of Windows 8.1, Windows 7, and Windows Vista
Memory (RAM)	<ul style="list-style-type: none">• 32-bit Windows 8.1, Windows 7, or Windows Vista: 1 GB or more (2 GB or more recommended)• 64-bit Windows 8.1, Windows 7, or Windows Vista: 2 GB or more (4 GB or more recommended)
Hard disk space	A minimum of 1 GB available on the startup disk (3 GB or more recommended)
Graphics	<ul style="list-style-type: none">• Resolution: 1024 × 768 pixels (XGA) or more (1280 × 1024 pixels or more recommended)• Color: 24-bit color (True Color) or more
Interface	Built-in USB port required. Software may not function as expected if camera is connected via USB hub.

* See the websites listed on page xxii for the latest information on supported operating systems.

Mac

CPU	<ul style="list-style-type: none">• Photos: Intel Core or Xeon series• Movies (playback): Core Duo 2 GHz or better; Intel Core i5 or better recommended when viewing movies with a frame size of 1280 × 720 or more at a frame rate of 30 fps or above or movies with a frame size of 1920 × 1080 or more• Movies (editing): Intel Core i5 or better
OS*	OS X 10.9, 10.8, or 10.7
Memory (RAM)	2 GB or more (4 GB or more recommended)
Hard disk space	A minimum of 1 GB available on the startup disk (3 GB or more recommended)
Graphics	<ul style="list-style-type: none">• Resolution: 1024 × 768 pixels (XGA) or more (1280 × 1024 pixels or more recommended)• Color: 24-bit color (millions of colors) or more
Interface	Built-in USB port required. Software may not function as expected if camera is connected via USB hub.

* See the websites listed on page xxii for the latest information on supported operating systems.

Using ViewNX 2

Copy Pictures to the Computer

Before proceeding, be sure you have installed the software on the supplied ViewNX 2 CD (□ 253).

1 Connect the USB cable.

After turning the camera off and ensuring that a memory card is inserted, connect the supplied USB cable as shown and then turn the camera on.

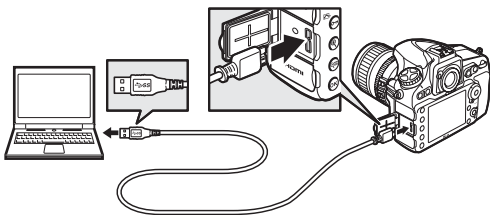

✔ Use a Reliable Power Source

To ensure that data transfer is not interrupted, be sure the camera battery is fully charged.

✔ Connecting Cables

Be sure the camera is off when connecting or disconnecting interface cables. Do not use force or attempt to insert the connectors at an angle.

✔ During Transfer

Do not turn the camera off or disconnect the USB cable while transfer is in progress.

The USB Cable Clip

To prevent cable from being disconnected, attach the supplied clip as shown.

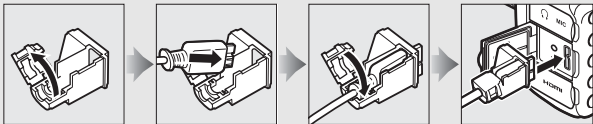

USB Hubs

Connect the camera directly to the computer; do not connect the cable via a USB hub or keyboard.

2 Start Nikon Transfer 2 component of ViewNX 2.

If a message is displayed prompting you to choose a program, select Nikon Transfer 2.

Windows 7

If the following dialog is displayed, select Nikon Transfer 2 as described below.

- 1** Under **Import pictures and videos**, click **Change program**. A program selection dialog will be displayed; select **Import File using Nikon Transfer 2** and click **OK**.
- 2** Double-click **Import File**.



Windows 8.1

Windows 8.1 may display an AutoPlay prompt when the camera is connected. Tap or click the dialog and then tap or click **Import File/Nikon Transfer 2** to select Nikon Transfer 2.

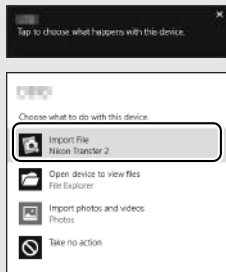

3 Click **Start Transfer**.

At default settings, pictures on the memory card will be copied to the computer.



Start Transfer

4 Terminate the connection.

When transfer is complete, turn the camera off and disconnect the USB cable.

Starting ViewNX 2 Manually

- Windows: Double-click the ViewNX 2 shortcut on the desktop.
- Mac: Click the ViewNX 2 icon in the Dock.

For More Information

Consult online help for more information on using ViewNX 2.

Capture NX-D

Use Nikon's Capture NX-D software to retouch photos or to change settings for NEF (RAW) pictures and save them in other formats. Capture NX-D also offers an Image Dust Off feature that removes image artifacts caused by dust inside the camera. Capture NX-D is available for download from a link in the ViewNX 2 installer (☞ 253).

Ethernet and Wireless Networks

The optional UT-1 communication unit (☐ 437) can be used to upload photographs to a computer or ftp server. The camera connects to the UT-1 using the USB cable supplied with the camera, while the UT-1 in turn connects to the network via an Ethernet cable or an optional WT-5 wireless transmitter (☐ 437). The optional communication units and wireless transmitters support the following modes:

Mode	Function
FTP upload	Upload existing photos and movies to a computer or ftp server, or upload new photos as they are taken.
Image transfer	
Camera control	Control the camera using optional Camera Control Pro 2 software and save new photos and movies directly to the computer.
HTTP server	View and take pictures remotely using a browser equipped computer or iPhone.

For information on using optional communication units or wireless transmitters, refer to the manuals provided with the device. Be sure to update to the latest versions of the device firmware and related software.

✔ **During Transfer**

Movies can not be recorded or played back when the UT-1 is connected and there are either images remaining to be sent or images currently being transferred via an Ethernet or wireless network.

✍ **Movies**

Movies can be uploaded over Ethernet and wireless networks in transfer mode. Note, however, that movies can not be uploaded using the **Auto send** or **Send folder** features in the **Options** menu.

✔ **HTTP Server Mode**

The camera can not be used to record or view movies in HTTP server mode.

✍ **WT-5 Wireless Transmitters**

The principal differences between the WT-5 and WT-5A/B/C/D/E is in the number of channels supported; unless otherwise stated, all references to the the WT-5 also apply to the WT-5A/B/C/D/E.

Printing Photographs

Selected JPEG images can be printed on a PictBridge printer (📖 485) connected directly to the camera.

Connecting the Printer

Connect the camera using the supplied USB cable. Do not use force or attempt to insert the connectors at an angle.

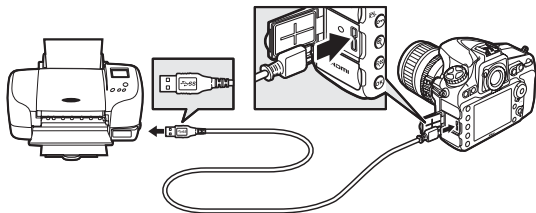

When the camera and printer are turned on, a welcome screen will be displayed in the monitor, followed by a PictBridge playback display.

USB Hubs

Connect the camera directly to the printer; do not connect the cable via a USB hub.

Selecting Photographs for Printing





Images created at image quality settings of NEF (RAW) or TIFF (RGB) (📖 79) can not be selected for printing. JPEG copies of NEF (RAW) images can be created using the **NEF (RAW) processing** option in the retouch menu (📖 399).

Printing Via Direct USB Connection

Be sure the battery is fully charged or use an optional AC adapter and power connector. When taking photographs to be printed via direct USB connection, set **Color space** to **sRGB** (📖 296).

Printing Pictures One at a Time

1 Display the desired picture.

Press  or  to view additional pictures. Press the  button to zoom in on the current frame (press the center of the multi selector to exit zoom). To view thumbnails, press the center of the multi selector. Use the multi selector to highlight pictures, or press the center of the multi selector again to display the highlighted picture full frame. To view images in other locations, press  when thumbnails are displayed and select the desired card and folder as described on page 237.

See Also

See page 472 for information on what to do if an error occurs during printing.

2 Adjust printing options.

Press **OK** to display the following items, then press **Left** or **Right** to highlight an item and press **Enter** to view options (only options supported by the current printer are listed; to use the default option, select **Printer default**). After selecting an option, press **OK** to return to the printer settings menu.

Option	Description
Page size	Choose a page size.
No. of copies	This option is listed only when pictures are printed one at a time. Press Left or Right to choose number of copies (maximum 99).
Border	Choose whether to frame photos in white borders.
Time stamp	Choose whether to print the times and dates of recordings on photos.
Cropping	This option is listed only when pictures are printed one at a time. To exit without cropping, highlight No cropping and press OK . To crop the current picture, highlight Crop and press Enter . A crop selection dialog will be displayed; press Right to increase the size of the crop, Left to decrease, and use the multi selector to position the crop. Note that print quality may drop if small crops are printed at large sizes.

3 Start printing.

Select **Start printing** and press **OK** to start printing. To cancel before all copies have been printed, press **OK**.







Printing Multiple Pictures

1 Display the PictBridge menu.

Press the MENU button in the PictBridge playback display.

2 Choose an option.



Highlight one of the following options and press .

- **Print select:** Select pictures for printing. Use the multi selector to highlight pictures (to view images in other locations, press  and select the desired card and folder as described on page 237; to display the current picture full screen, press and hold the  button) and, keeping the  (/?) button pressed, press  or  to choose the number of prints (maximum 99). To deselect a picture, set the number of prints to zero.
 - **Print (DPOF):** Print the current DPOF print order ( 267). The order can be viewed and modified before printing as described in the description for **Print select**, above.
 - **Index print:** To create an index print of all JPEG pictures on the memory card, proceed to Step 3. Note that if the memory card contains more than 256 pictures, only the first 256 images will be printed. A warning will be displayed if the page size selected in Step 3 is too small for an index print.
-

3 Adjust printing options.

Adjust printer settings as described in Step 2 on page 265.

4 Start printing.

Select **Start printing** and press  to start printing. To cancel before all copies have been printed, press .

Creating a DPOF Print Order: Print Set

The **DPOF print order** option in the playback menu is used to create digital “print orders” for PictBridge-compatible printers and devices that support DPOF (📖 485).

1 Choose DPOF print order > Select/set.

Select **DPOF print order** in the playback menu, then highlight **Select/set** and press **▶** (to remove all photographs from the print order, select **Deselect all**).

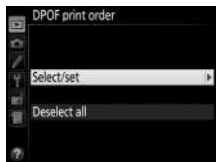

2 Select pictures.

Use the multi selector to highlight pictures (to view images in other locations, press **🔍** and select the desired card and folder as described on page 237; to display the current picture full screen, press and hold the **🔍** button) and, keeping the **🔍** (🔍/?) button pressed, press **▲** or **▼** to choose the number of prints (maximum 99). To deselect a picture, set the number of prints to zero. Press **OK** when all the desired pictures have been selected.



3 Select imprint options.

Highlight the following options and press  to toggle the highlighted option on or off.

- **Print shooting data:** Print shutter speed and aperture on all pictures in print order.
- **Print date:** Print date of recording on all pictures in print order.

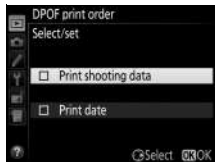

4 Complete the print order.

Press  to complete the print order.

DPOF Print Orders

To print the current print order when the camera is connected to a PictBridge printer, select **Print (DPOF)** in the PictBridge menu and follow the steps in "Printing Multiple Pictures" to modify and print the current order (□ 266). DPOF print date and shooting data options are not supported when printing via direct USB connection; to print the date of recording on photographs in the current print order, use the PictBridge **Time stamp** option.

The **DPOF print order** option can not be used if there is not enough space on the memory card to store the print order.

NEF (RAW) photographs (□ 79) can not be selected for printing using this option. JPEG copies of NEF (RAW) images can be created using the **NEF (RAW) processing** option in the retouch menu (□ 399).

Print orders may not print correctly if images are deleted using a computer or other device after the print order is created.

Viewing Photographs on TV

The optional High-Definition Multimedia Interface (HDMI) cable (☞ 440) or a type C HDMI cable (available separately from third-party suppliers) can be used to connect the camera to high-definition video devices. Always turn the camera off before connecting or disconnecting an HDMI cable.

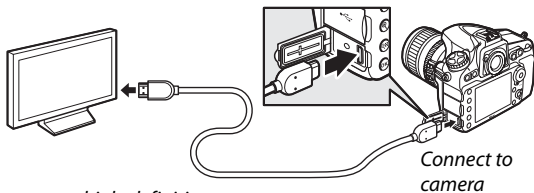

Connect to high-definition device (choose cable with connector for HDMI device)

Tune the device to the HDMI channel, then turn the camera on and press the  button. During playback, images will be displayed on the television screen. Volume can be adjusted using television controls; the camera controls can not be used.

The HDMI Cable Clip

When using the optional Nikon HDMI cable, attach the supplied clip as shown to prevent accidental disconnection. Do not use cable clips with non-Nikon cables.

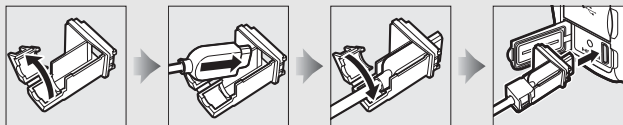

HDMI Options

The **HDMI** option in the setup menu (📖 365) controls output resolution and other advanced HDMI options.

■ Output Resolution

Choose the format for images output to the HDMI device. If **Auto** is selected, the camera will automatically select the appropriate format.

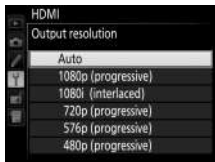

■ Advanced

Option	Description
Output range	<p>Auto is recommended in most situations. If the camera is unable to determine the correct RGB video signal output range for the HDMI device, you can choose from the following options:</p> <ul style="list-style-type: none">• Limited range: For devices with an RGB video signal input range of 16 to 235. Choose this option if you notice loss of detail in shadows.• Full range: For devices with an RGB video signal input range of 0 to 255. Choose this option if shadows are “washed out” or too bright.
Output display size	Choose horizontal and vertical frame coverage for HDMI output from 95% or 100%.
Live view on-screen display	If Off is selected when the camera is connected to an HDMI device, shooting information will not be displayed in the monitor during live view photography.
Dual monitor	Choose On to mirror the HDMI display on the camera monitor, Off to turn the camera monitor off to save power. Dual monitor turns on automatically when Live view on-screen display is Off .

🔍 **Television Playback**

Use of an AC adapter and power connector (available separately) is recommended for extended playback. If the edges of photographs are not visible in the television display, select **95%** for **HDMI > Advanced > Output display size** (📖 270).

🔍 **HDMI and Live View**

When the camera is connected via an HDMI cable, HDMI displays can be used for live view photography and movie live view (📖 48, 59). Note that if **1920 × 1080; 60p** is selected for the **Movie settings > Frame size/frame rate** option in the shooting menu (📖 62), the selected setting will only be reflected in the HDMI output during movie recording if all the following conditions are met: **Auto** or **1080p (progressive)** is selected for **HDMI > Output resolution**, **100%** is selected for **HDMI > Advanced > Output display size**, and **Off** is selected for **HDMI > Advanced > Live view on-screen display** (📖 270). At other settings, the output resolution, display size, or frame rate may differ from that selected in the camera menus.

Menu Guide

Defaults

The default settings for the options in the camera menus are listed below. For information on two-button reset, see page 206.

■ Playback Menu Defaults

Option	Default
Playback folder (☐ 281)	ND810
Image review (☐ 287)	Off
After delete (☐ 287)	Show next
Rotate tall (☐ 288)	On
Slide show (☐ 288)	
Image type (☐ 288)	Still images and movies
Frame interval (☐ 288)	2 s

■ Shooting Menu Defaults¹

Option	Default
Extended menu banks (☐ 292)	Off
File naming (☐ 295)	DSC
Primary slot selection (☐ 86)	SD card slot
Secondary slot function (☐ 86)	Overflow
Image quality (☐ 79)	JPEG normal
JPEG/TIFF recording (☐ 295)	
Image size (☐ 83)	Large
JPEG compression (☐ 81)	Size priority
NEF (RAW) recording (☐ 295)	
Image size (☐ 85)	Large
NEF (RAW) compression (☐ 81)	Lossless compressed
NEF (RAW) bit depth (☐ 82)	14-bit

Option	Default
Image area (☐ 74)	
Choose image area (☐ 75)	FX (36×24)
Auto DX crop (☐ 75)	On
White balance (☐ 148)	
Fine-tuning (☐ 151)	A-B: 0, G-M: 0
Choose color temp. (☐ 155)	5000 K
Preset manual (☐ 158)	d-1
Set Picture Control (☐ 170)	Standard
Color space (☐ 296)	sRGB
Active D-Lighting (☐ 182)	Off
HDR (high dynamic range) (☐ 184)	
HDR mode (☐ 185)	Off
Exposure differential (☐ 186)	Auto
Smoothing (☐ 186)	Normal
Vignette control (☐ 297)	Normal
Auto distortion control (☐ 298)	Off
Long exposure NR (☐ 299)	Off
High ISO NR (☐ 299)	Normal
ISO sensitivity settings (☐ 109)	
ISO sensitivity (☐ 109)	100
Auto ISO sensitivity control (☐ 111)	Off
Multiple exposure (☐ 209)²	
Multiple exposure mode (☐ 210)	Off
Number of shots (☐ 211)	2
Auto gain (☐ 212)	On

Option	Default
Interval timer shooting (☐ 216)	Off
Start options (☐ 217)	Now
Interval (☐ 217)	1 min.
No. of intervals×shots/interval (☐ 218)	0001×1
Exposure smoothing (☐ 218)	Off
Time-lapse photography (☐ 223)	Off
Interval (☐ 224)	5 s
Shooting time (☐ 224)	25 minutes
Exposure smoothing (☐ 224)	On
Movie settings (☐ 62)	
Frame size/frame rate (☐ 62)	1920 × 1080; 60p
Movie quality (☐ 62)	Normal
Microphone sensitivity (☐ 62)	Auto sensitivity
Frequency response (☐ 63)	Wide range
Wind noise reduction (☐ 63)	Off
Destination (☐ 63)	SD card slot
Movie ISO sensitivity settings (☐ 64)	ISO sensitivity (mode M): 100 Auto ISO control (mode M): Off Maximum sensitivity: 12800

- 1 Default settings can be restored using **Shooting menu bank** (☐ 291). With the exception of **Extended menu banks**, **Multiple exposure**, **Interval timer shooting**, and **Time-lapse photography**, only settings in the current shooting menu bank will be reset.
- 2 Shooting menu reset is not available while shooting is in progress.

■ Custom Settings Menu Defaults*

	Option	Default
a1	AF-C priority selection (☐ 306)	Release
a2	AF-S priority selection (☐ 307)	Focus
a3	Focus tracking with lock-on (☐ 308)	3 (Normal)
a4	AF activation (☐ 308)	Shutter/AF-ON
a5	Focus point illumination (☐ 309)	
	Manual focus mode	On
	Dynamic-area AF display	Off
	Group-area AF illumination	☒ (Squares)
a6	AF point illumination (☐ 310)	Auto
a7	Focus point wrap-around (☐ 310)	No wrap
a8	Number of focus points (☐ 311)	51 points
a9	Store by orientation (☐ 312)	Off
a10	Built-in AF-assist illuminator (☐ 313)	On
a12	Autofocus mode restrictions (☐ 314)	No restrictions
b1	ISO sensitivity step value (☐ 315)	1/3 step
b2	EV steps for exposure cntrl (☐ 315)	1/3 step
b3	Exp./flash comp. step value (☐ 315)	1/3 step
b4	Easy exposure compensation (☐ 316)	Off
b5	Matrix metering (☐ 317)	Face detection on
b6	Center-weighted area (☐ 317)	Ø 12 mm
b7	Fine-tune optimal exposure (☐ 318)	
	Matrix metering	0
	Center-weighted metering	0
	Spot metering	0
	Highlight-weighted metering	0

	Option	Default
c1	Shutter-release button AE-L (☐ 319)	Off
c2	Standby timer (☐ 319)	6 s
c3	Self-timer (☐ 319)	
	Self-timer delay	10 s
	Number of shots	1
	Interval between shots	0.5 s
c4	Monitor off delay (☐ 320)	
	Playback	10 s
	Menus	1 min
	Information display	10 s
	Image review	4 s
	Live view	10 min
d1	Beep (☐ 321)	
	Volume	Off
	Pitch	Low
d2	CL mode shooting speed (☐ 321)	3 fps
d3	Max. continuous release (☐ 322)	100
d4	Exposure delay mode (☐ 322)	Off
d5	Electronic front-curtain shutter (☐ 323)	Disable
d6	File number sequence (☐ 324)	On
d7	Viewfinder grid display (☐ 325)	Off
d8	ISO display and adjustment (☐ 325)	Show frame count
d9	Screen tips (☐ 325)	On
d10	Information display (☐ 326)	Auto
d11	LCD illumination (☐ 326)	Off
d12	MB-D12 battery type (☐ 327)	LR6 (AA alkaline)
d13	Battery order (☐ 328)	Use MB-D12 batteries first

	Option	Default
e1	Flash sync speed (☐ 329)	1/250 s
e2	Flash shutter speed (☐ 331)	1/60 s
e3	Flash cntrl for built-in flash/Optional flash (☐ 331, 333)	TTL
e4	Exposure comp. for flash (☐ 338)	Entire frame
e5	Modeling flash (☐ 338)	On
e6	Auto bracketing set (☐ 338)	AE & flash
e7	Auto bracketing (Mode M) (☐ 339)	Flash/speed
e8	Bracketing order (☐ 340)	MTR > under > over
f1	☼ switch (☐ 341)	LCD backlight (☼)
f2	Multi selector center button (☐ 341)	
	Shooting mode	Select center focus point
	Playback mode	Thumbnail on/off
	Live view	Select center focus point
f3	Multi selector (☐ 343)	Do nothing
f4	Assign Fn button (☐ 343)	
	Press (☐ 344)	Viewfinder virtual horizon
	Press + command dials (☐ 348)	None
f5	Assign preview button (☐ 349)	
	Press	Preview
	Press + command dials	None
f6	Assign AE-L/AF-L button (☐ 349)	
	Press	AE/AF lock
	Press + command dials	None
f7	Shutter spd & aperture lock (☐ 350)	
	Shutter speed lock	Off
	Aperture lock	Off
f8	Assign BKT button (☐ 350)	Auto bracketing

	Option	Default
f9	Customize command dials (☐ 351)	
	Reverse rotation (☐ 351)	Exposure compensation: <input type="checkbox"/> Shutter speed/aperture: <input type="checkbox"/>
	Change main/sub (☐ 351)	Exposure setting: Off Autofocus setting: Off
	Aperture setting (☐ 352)	Sub-command dial
	Menus and playback (☐ 352)	Off
	Sub-dial frame advance (☐ 352)	10 frames
f10	Release button to use dial (☐ 353)	No
f11	Slot empty release lock (☐ 354)	Enable release
f12	Reverse indicators (☐ 354)	
f13	Assign movie record button (☐ 355)	
	Press + command dials	None
f14	Live view button options (☐ 356)	Enable
f15	Assign MB-D12 AF-ON (☐ 356)	AF-ON
f16	Assign remote (WR) Fn button (☐ 357)	None
f17	Lens focus function buttons (☐ 359)	AF lock only
g1	Assign Fn button (☐ 361)	
	Press	None
g2	Assign preview button (☐ 362)	
	Press	Index marking
g3	Assign AE-L/AF-L button (☐ 363)	
	Press	AE/AF lock
g4	Assign shutter button (☐ 364)	Take photos

* Defaults for the current Custom Settings bank can be restored using **Custom settings bank** (☐ 304).

■ ■ Setup Menu Defaults

Option	Default
Monitor brightness (☞ 367)	0
Monitor color balance (☞ 368)	A-B: 0, G-M: 0
Clean image sensor (☞ 445)	
Clean at startup/shutdown (☞ 446)	Clean at startup & shutdown
Flicker reduction (☞ 371)	Auto
Time zone and date (☞ 372)	
Daylight saving time (☞ 372)	Off
Auto image rotation (☞ 373)	On
HDMI (☞ 269)	
Output resolution (☞ 270)	Auto
Advanced (☞ 270)	
Output range	Auto
Output display size	100%
Live view on-screen display	Off
Dual monitor	On
Location data (☞ 234)	
Standby timer	Enable
Set clock from satellite	Yes
Eye-Fi upload (☞ 382)	Enable

▶ The Playback Menu: *Managing Images*

To display the playback menu, press MENU and select the  (playback menu) tab.

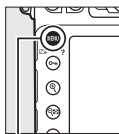

MENU button

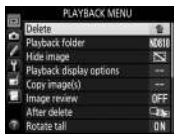
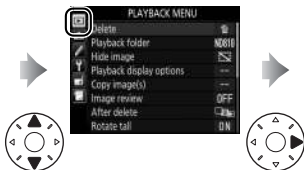

Playback Menu Options

The playback menu contains the following options:

Option		Option	
Delete	252	Image review	287
Playback folder	281	After delete	287
Hide image	281	Rotate tall	288
Playback display options	282	Slide show	288
Copy image(s)	283	DPOF print order	267

See Also

Menu defaults are listed on page 272.

Playback Folder

MENU button →  playback menu

Choose a folder for playback ( 235).

Option	Description
ND810	Pictures in all folders created with the D810 will be visible during playback.
All	Pictures in all folders will be visible during playback.
Current	Only pictures in the current folder will be visible during playback.

Hide Image



MENU button →  playback menu

Hide or reveal selected pictures as described below. Hidden pictures are visible only in the **Hide image** menu and can only be deleted by formatting the memory card.

Protected and Hidden Images



Revealing a protected image will also remove protection from the image.

1 Choose **Select/set**.

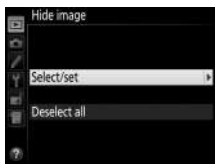
Highlight **Select/set** and press  (to skip the remaining steps and reveal all pictures, highlight **Deselect all** and press .



2 Select pictures.

Use the multi selector to scroll through the pictures on the memory card (to view the highlighted picture full screen, press and hold the  button; to view images in other locations, press  and select the desired card and folder as described on page 237) and press the center of the multi selector to select the current picture. Selected pictures are marked by a  icon; to deselect a picture, highlight it and press the center of the multi selector again. Continue until all the desired pictures have been selected.









3 Press .

Press  to complete the operation.

Playback Display Options

MENU button →  playback menu

Choose the information available in the playback photo information display (book 238). Press  or  to highlight an option, then press  to select the option for the photo information display. A  appears next to selected items; to deselect, highlight an item and press . To return to the playback menu, press .

Copy Image(s)

MENU button →  playback menu

Copy pictures from one memory card to another. This option is only available when two memory cards are inserted in the camera.

Option	Description
Select source	Choose card from which pictures will be copied.
Select image(s)	Select pictures to be copied.
Select destination folder	Select destination folder on remaining card.
Copy image(s)?	Copy selected pictures to specified destination.

1 Choose **Select source**.

Highlight **Select source** and press .

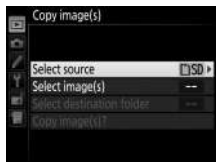

2 Select the source card.

Highlight the slot for the card containing the images to be copied and press .

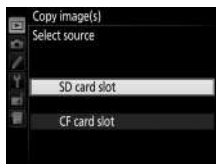

3 Choose **Select image(s)**.

Highlight **Select image(s)** and press .



4 Select the source folder.

Highlight the folder containing the images to be copied and press .





5 Make the initial selection.

Before going on select or deselect individual images, you can mark all or all protected images in the folder for copying by choosing **Select all images** or **Select protected images**.

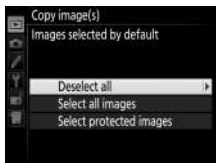
To mark only individually selected images for copying, choose **Deselect all** before proceeding.



6 Select additional images.

Highlight pictures and press the center of the multi selector to select or deselect (to view the highlighted picture full screen, press and hold the  button). Selected images are marked with a ✓. Press  to proceed to Step 7 when your selection is complete.



-
- 7** Choose **Select destination folder**. Highlight **Select destination folder** and press **↩**.

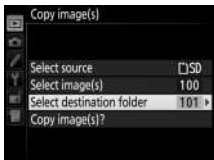

-
- 8** Select a destination folder. To enter a folder number, choose **Select folder by number**, enter the number (📖 293), and press **Ⓜ**.



To choose from a list of existing folders, choose **Select folder from list**, highlight a folder, and press **Ⓜ**.

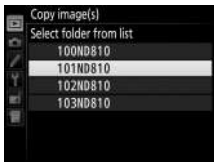

9 Copy the images.

Highlight **Copy image(s)?** and press **OK**.

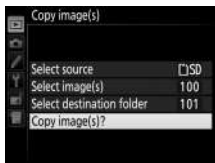

A confirmation dialog will be displayed; highlight **Yes** and press **OK**. Press **OK** again to exit when copying is complete.



✓ Copying Images

Images will not be copied if there is insufficient space on the destination card. Be sure the battery is fully charged before copying movies.

If the destination folder contains an image with the same name as one of the images to be copied, a confirmation dialog will be displayed. Select **Replace existing image** to replace the image with the image to be copied, or select **Replace all** to replace all existing images with the same names without further prompting. To continue without replacing the image, select **Skip**, or select **Cancel** to exit without copying any further images. Hidden or protected files in the destination folder will not be replaced.

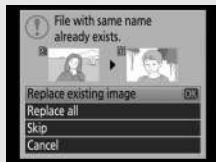

Protect status is copied with the images but print marking (📄 267) is not. Hidden images can not be copied.

Image Review



MENU button →  playback menu

Choose whether pictures are automatically displayed in the monitor immediately after shooting. If **Off** is selected, pictures can only be displayed by pressing the  button.

After Delete

MENU button →  playback menu

Choose the picture displayed after an image is deleted.

Option	Description
 Show next	Display following picture. If deleted picture was last frame, previous picture will be displayed.
 Show previous	Display previous picture. If deleted picture was first frame, following picture will be displayed.
 Continue as before	If user was scrolling through pictures in order recorded, following picture will be displayed as described for Show next . If user was scrolling through pictures in reverse order, previous picture will be displayed as described for Show previous .

Rotate Tall

MENU button →  playback menu

Choose whether to rotate “tall” (portrait-orientation) pictures for display during playback. Note that because the camera itself is already in the appropriate orientation during shooting, images are not rotated automatically during image review.

Option	Description
On	“Tall” (portrait-orientation) pictures are automatically rotated for display in the camera monitor. Pictures taken with Off selected for Auto image rotation (📖 373) will be displayed in “wide” (landscape) orientation.
Off	“Tall” (portrait-orientation) pictures are displayed in “wide” (landscape) orientation.

Slide Show









MENU button →  playback menu

Create a slide show of the pictures in the current playback folder (📖 281). Hidden images (📖 281) are not displayed.

Option	Description
Start	Start slide show.
Image type	Choose type of image displayed from Still images and movies , Still images only , and Movies only .
Frame interval	Choose how long each photo will be displayed.

To start the slide show, highlight **Start** and press **OK**. The following operations can be performed while the slide show is in progress:



To	Press	Description
Skip back/skip ahead		Press  to return to previous frame,  to skip to next frame.
View additional photo info		Change or hide photo info displayed (still images only;  238).
Pause		Pause slide show. Select Restart to resume.
Exit to playback menu	MENU	End slide show and return to playback menu.
Exit to playback mode		End slide show and exit to playback mode.
Exit to shooting mode		Press shutter-release button halfway to return to shooting mode.

The dialog shown at right is displayed when the show ends. Select **Restart** to restart or **Exit** to return to the playback menu.

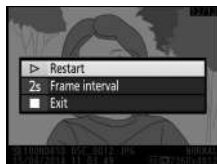

The Shooting Menu: *Shooting Options*

To display the shooting menu, press **MENU** and select the  (shooting menu) tab.

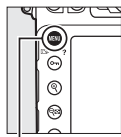



MENU button



Shooting Menu Options

The shooting menu contains the following options:

Option	
Shooting menu bank	291
Extended menu banks	292
Storage folder	293
File naming	295
Primary slot selection	86
Secondary slot function	86
Image quality	79
JPEG/TIFF recording	81, 83
NEF (RAW) recording	81
Image area	74
White balance	148
Set Picture Control	170
Manage Picture Control	177

Option	
Color space	296
Active D-Lighting	182
HDR (high dynamic range)	184
Vignette control	297
Auto distortion control	298
Long exposure NR	299
High ISO NR	299
ISO sensitivity settings	109
Multiple exposure	209
Interval timer shooting	216
Time-lapse photography	223
Movie settings	62

See Also

Menu defaults are listed on page 272.

Shooting Menu Bank

MENU button →  shooting menu

Shooting menu options are stored in one of four banks. With the exceptions of **Extended menu banks**, **Multiple exposure**, **Interval timer shooting**, **Time-lapse photography**, and modifications to Picture Controls (quick adjust and other manual adjustments), changes to settings in one bank have no effect on the others. To store a particular combination of frequently-used settings, select one of the four banks and set the camera to these settings. The new settings will be stored in the bank even when the camera is turned off, and will be restored the next time the bank is selected. Different combinations of settings can be stored in the other banks, allowing the user to switch instantly from one combination to another by selecting the appropriate bank from the bank menu.

The default names for the four shooting menu banks are A, B, C, and D. A descriptive caption up to 20 characters long can be added as described on page 178 by highlighting the menu bank and pressing .

Shooting Menu Bank



The information display shows the current shooting menu bank.





See Also

Exposure and flash modes, shutter speed, and aperture can be included in shooting menu banks using the **Extended menu banks** option in the shooting menu ( 292).

■ Restoring Default Settings

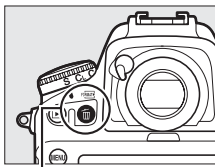
To restore default settings, highlight a bank in the **Shooting menu bank** menu and press  (FORMAT). A confirmation dialog will be displayed; highlight **Yes** and press  to restore default settings for the selected bank. See page 272 for a list of default settings.



 (FORMAT) button

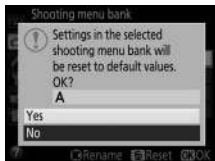



Extended Menu Banks

MENU button →  shooting menu











Select **On** to include exposure and flash modes, shutter speed (modes **S** and **M** only), and aperture (modes **A** and **M** only) in the information recorded in each of the four shooting menu banks, to be recalled whenever the bank is selected. Selecting **Off** restores the values in effect before **On** was selected.

Select the folder in which subsequent images will be stored.

■ ■ *Select Folder by Number*

- 1 Choose **Select folder by number**.**
Highlight **Select folder by number** and press . The dialog shown at right will be displayed, with the current primary slot ( 86) underlined.





- 2 Choose a folder number.**
Press  or  to highlight a digit, press  or  to change. If a folder with the selected number already exists, a , , or  icon will be displayed to the left of the folder number:
 -  : Folder is empty.
 -  : Folder is partially full.
 -  : Folder contains 999 pictures or a picture numbered 9999. No further pictures can be stored in this folder.

- 3 Save changes and exit.**
Press  to complete the operation and return to the shooting menu (to exit without changing the storage folder, press the MENU button). If a folder with the specified number does not already exist, a new folder will be created on the card in the primary slot. Subsequent photographs will be stored in the selected folder unless it is already full.

■ Select Folder from List

- 1 Choose Select folder from list.**
Highlight **Select folder from list** and press .



- 2 Highlight a folder.**
Press  or  to highlight a folder.

- 3 Select the highlighted folder.**
Press  to select the highlighted folder and return to the shooting menu. Subsequent photographs will be stored in the selected folder.

Folder and File Numbers

If the current folder is numbered 999 and contains 999 pictures or a picture numbered 9999, the shutter-release will be disabled and no further photographs can be taken. To continue shooting, create a folder with a number less than 999, or select an existing folder with a number less than 999 and less than 999 images.

Startup Time

Additional time may be required for camera startup if the memory card contains a very large number of files or folders.

File Naming

MENU button →  shooting menu

Photographs are saved using file names consisting of “DSC_” or, in the case of images that use the Adobe RGB color space (📖 296), “_DSC”, followed by a four-digit number and a three-letter extension (e.g., “DSC_0001.JPG”). The **File naming** option is used to select three letters to replace the “DSC” portion of the file name. For information on editing file names, see page 178.

Extensions

The following extensions are used: “NEF” for NEF (RAW) images, “.TIF” for TIFF (RGB) images, “.JPG” for JPEG images, “.MOV” for movies, and “.NDF” for dust off reference data. In each pair of photographs recorded at image-quality settings of NEF (RAW)+JPEG, the NEF and JPEG images have the same file names but different extensions.

JPEG/TIFF Recording

MENU button →  shooting menu

Adjust size settings for photographs taken in JPEG and TIFF formats (📖 83) and choose a compression option for JPEG photographs (📖 81).

NEF (RAW) Recording

MENU button →  shooting menu

Choose the compression (📖 81), bit-depth (📖 82), and size (📖 85) of photographs recorded in NEF (RAW) format.

The color space determines the gamut of colors available for color reproduction. **sRGB** is recommended for movies and for photographs taken for general-purpose printing and display, while **Adobe RGB**, with its broader gamut of colors, is recommended for photographs taken for professional publication and commercial printing.

Adobe RGB

For accurate color reproduction, Adobe RGB images require applications, displays, and printers that support color management.

Color Space





ViewNX 2 (supplied) and Nikon's Capture NX-D software (☐ 260) automatically select the correct color space when opening photographs created with this camera. Results can not be guaranteed with third-party software.

Vignette Control

MENU button →  shooting menu

“Vignetting” is a drop in brightness at the edges of a photograph. **Vignette control** reduces vignetting for type G, E, and D lenses (PC lenses excluded). Its effects vary from lens to lens and are most noticeable at maximum aperture. Choose from **High**, **Normal**, **Low**, and **Off**.

Vignette Control

Depending on the scene, shooting conditions, and type of lens, TIFF and JPEG images may exhibit noise (fog) or variations in peripheral brightness, while custom Picture Controls and preset Picture Controls that have been modified from default settings may not produce the desired effect. Take test shots and view the results in the monitor. Vignette control does not apply to movies ( 49), multiple exposures ( 209), or pictures taken with an FX lens and **DX (24 × 16)** selected for **Image area > Choose image area** ( 75) or with a DX lens, an option other than **DX (24 × 16)** selected for **Choose image area**, and **Off** selected for **Image area > Auto DX crop** ( 75).

Auto Distortion Control

MENU button →  shooting menu

Select **On** to reduce barrel distortion when shooting with wide-angle lenses and to reduce pin-cushion distortion when shooting with long lenses (note that the edges of the area visible in the viewfinder may be cropped out of the final photograph, and that the time needed to process photographs before recording begins may increase). This option does not apply to movies and is available only with type G, E, and D lenses (PC, fisheye, and certain other lenses excluded); results are not guaranteed with other lenses. Before using auto distortion control with DX lenses, select **On** for **Auto DX crop** or choose an image area of **DX (24×16)** as described on page 75; selecting other options may result in heavily cropped photographs or in photographs with severe peripheral distortion.

Retouch: Distortion Control

For information on creating copies of existing photographs with reduced barrel and pin-cushion distortion, see page 405.

Long Exposure NR (Long Exposure Noise Reduction)

MENU button →  shooting menu

If **On** is selected, photographs taken at shutter speeds slower than 1 s will be processed to reduce noise (bright spots, randomly-spaced bright pixels, or fog). The time required for processing roughly doubles; during processing, “**Job nr**” will flash in the shutter speed/aperture displays and pictures can not be taken (if the camera is turned off before processing is complete, the picture will be saved but noise reduction will not be performed). In continuous release mode, frame rates will slow and while photographs are being processed, the capacity of the memory buffer will drop. Long exposure noise reduction is not available during movie recording.

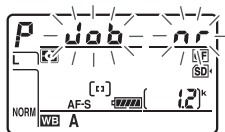

High ISO NR

MENU button →  shooting menu

Photographs taken at high ISO sensitivities can be processed to reduce noise.

Option	Description
High	Reduce noise (randomly-spaced bright pixels), particularly in photographs taken at high ISO sensitivities. Choose the amount of noise reduction performed from High , Normal , and Low .
Normal	
Low	
Off	Noise reduction is performed only as required and never at an amount higher than when Low is selected.

Custom Settings: Fine-Tuning Camera Settings

To display the Custom Settings menu, press **MENU** and select the  (Custom Settings menu) tab.



Custom Settings are used to customize camera settings to suit individual preferences.

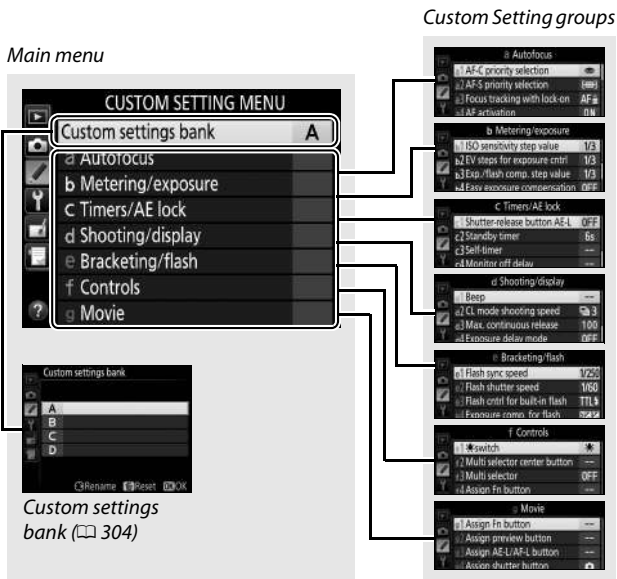

Custom Settings

The following Custom Settings are available:

Custom Setting		📖
Custom settings bank		304
a Autofocus		
a1	AF-C priority selection	306
a2	AF-S priority selection	307
a3	Focus tracking with lock-on	308
a4	AF activation	308
a5	Focus point illumination	309
a6	AF point illumination	310
a7	Focus point wrap-around	310
a8	Number of focus points	311
a9	Store by orientation	312
a10	Built-in AF-assist illuminator	313
a11	Limit AF-area mode selection	314
a12	Autofocus mode restrictions	314
b Metering/exposure		
b1	ISO sensitivity step value	315
b2	EV steps for exposure cntrl	315
b3	Exp./flash comp. step value	315
b4	Easy exposure compensation	316
b5	Matrix metering	317
b6	Center-weighted area	317
b7	Fine-tune optimal exposure	318
c Timers/AE lock		
c1	Shutter-release button AE-L	319
c2	Standby timer	319
c3	Self-timer	319
c4	Monitor off delay	320

d Shooting/display		
d1	Beep	321
d2	CL mode shooting speed	321
d3	Max. continuous release	322
d4	Exposure delay mode	322
d5	Electronic front-curtain shutter	323
d6	File number sequence	324
d7	Viewfinder grid display	325
d8	ISO display and adjustment	325
d9	Screen tips	325
d10	Information display	326
d11	LCD illumination	326
d12	MB-D12 battery type	327
d13	Battery order	328
e Bracketing/flash		
e1	Flash sync speed	329
e2	Flash shutter speed	331
e3	Flash cntrl for built-in flash	331
e4	Exposure comp. for flash	338
e5	Modeling flash	338
e6	Auto bracketing set	338
e7	Auto bracketing (Mode M)	339
e8	Bracketing order	340

f Controls		
f1	 switch	341
f2	Multi selector center button	341
f3	Multi selector	343
f4	Assign Fn button	343
f5	Assign preview button	349
f6	Assign AE-L/AF-L button	349
f7	Shutter spd & aperture lock	350
f8	Assign BKT button	350
f9	Customize command dials	351
f10	Release button to use dial	353
f11	Slot empty release lock	354
f12	Reverse indicators	354
f13	Assign movie record button	355
f14	Live view button options	356
f15	Assign MB-D12 AF-ON	356
f16	Assign remote (WR) Fn button	357
f17	Lens focus function buttons	359
g Movie		
g1	Assign Fn button	361
g2	Assign preview button	362
g3	Assign AE-L/AF-L button	363
g4	Assign shutter button	364



Custom Settings Bank

MENU button →  Custom Settings menu

Custom Settings are stored in one of four banks. Changes to settings in one bank have no effect on the others. To store a particular combination of frequently-used settings, select one of the four banks and set the camera to these settings. The new settings will be stored in the bank even when the camera is turned off, and will be restored the next time the bank is selected. Different combinations of settings can be stored in the other banks, allowing the user to switch instantly from one combination to another by selecting the appropriate bank from the bank menu.

The default names for the four Custom Settings banks are A, B, C, and D. A descriptive caption up to 20 characters long can be added as described on page 178 by highlighting the menu bank and pressing .

■ Restoring Default Settings

To restore default settings, highlight a bank in the **Custom settings bank** menu and press  (FORMAT). A confirmation dialog will be displayed; highlight **Yes** and press  to restore default settings for the selected bank ( 275).

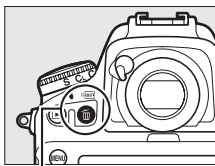

 (FORMAT) button



Custom Settings Bank

The information display shows the current Custom Settings bank.



See Also



Menu defaults are listed on page 275. If settings in the current bank have been modified from default values, an asterisk will be displayed adjacent to the altered settings in the second level of the Custom Settings menu.

a: Autofocus

a1: AF-C Priority Selection

MENU button →  Custom Settings menu

When **AF-C** is selected for viewfinder photography ( 87), this option controls whether photographs can be taken whenever the shutter-release button is pressed (*release priority*) or only when the camera is in focus (*focus priority*).



Option	Description
 Release	Photos can be taken whenever the shutter-release button is pressed.
 Release + focus	Photos can be taken even when the camera is not in focus. In continuous mode, frame rate slows for improved focus if the subject is dark or low contrast.
 Focus	Photos can only be taken when the in-focus indicator (●) is displayed.

Regardless of the option selected, focus will not lock when **AF-C** is selected for autofocus mode. The camera will continue to adjust focus until the shutter is released.

a2: AF-S Priority Selection

MENU button →  Custom Settings menu

When **AF-S** is selected for viewfinder photography ( 87), this option controls whether photographs can be taken only when the camera is in focus (*focus priority*) or whenever the shutter-release button is pressed (*release priority*).





Option	Description
 Release	Photos can be taken whenever the shutter-release button is pressed.
 Focus	Photos can only be taken when the in-focus indicator (●) is displayed.

Regardless of the option selected, if the in-focus indicator (●) is displayed when **AF-S** is selected for autofocus mode, focus will lock while the shutter-release button is pressed halfway. Focus lock continues until the shutter is released.

a3: Focus Tracking with Lock-On

MENU button →  Custom Settings menu

This option controls how autofocus adjusts to sudden large changes in the distance to the subject when **AF-C** (📖 87) is selected during viewfinder photography.

Option	Description
AF  5 (Long)	When the distance to the subject changes abruptly, the camera waits for the specified period before adjusting the distance to the subject. This prevents the camera from refocusing when the subject is briefly obscured by objects passing through the frame. Note that 2 , 1 (Short) , and Off are equivalent to 3 (Normal) when 3D-tracking or auto-area AF is selected for AF-area mode.
AF  4	
AF  3 (Normal)	
AF  2	
AF  1 (Short)	
Off	The camera immediately adjusts focus when the distance to the subject changes. Use when photographing a series of subjects at varying distances in quick succession.

a4: AF Activation









MENU button →  Custom Settings menu

If **Shutter/AF-ON** is selected, both the shutter-release button and the **AF-ON** button can be used to initiate autofocus. Select **AF-ON only** to prevent the camera focusing when the shutter-release button is pressed halfway.

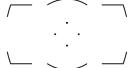
a5: Focus Point Illumination

MENU button →  Custom Settings menu

Choose from the following focus point display options.

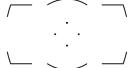
Option	Description					
Manual focus mode	Choose On to display the active focus point in manual focus mode, Off to display the focus point only during focus point selection.					
Dynamic-area AF display	Choose On to display both the selected focus point and the surrounding focus points in dynamic-area AF mode (☐ 90). When 3D-tracking is used, a dot will be displayed in the center of the focus point (☐). Select Off to display only the selected focus point.					
Group-area AF illumination	Choose how the active focus points are displayed in group-area AF (☐ 91).					
	<table border="1"><thead><tr><th>Option</th><th>Focus point display</th></tr></thead><tbody><tr><td></td><td></td></tr><tr><td></td><td></td></tr></tbody></table>	Option	Focus point display			
Option	Focus point display					
						
						

a6: AF Point Illumination

MENU button →  Custom Settings menu



Choose whether the active focus point is highlighted in red in the viewfinder.

Option	Description
Auto	The selected focus point is automatically highlighted as needed to establish contrast with the background.
On	The selected focus point is always highlighted, regardless of the brightness of the background. Depending on the brightness of the background, the selected focus point may be difficult to see.
Off	The selected focus point is not highlighted. The area outside the current crop is shown in grey (📖 76).

a7: Focus Point Wrap-Around

MENU button →  Custom Settings menu

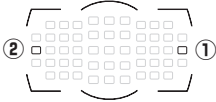
Choose whether focus-point selection “wraps around” from one edge of the viewfinder to another.

Option	Description
Wrap	Focus-point selection “wraps around” from top to bottom, bottom to top, right to left, and left to right, so that, for example, pressing  when a focus point at the right edge of the viewfinder display is highlighted (①) selects the corresponding focus point at the left edge of the display (②). 
No wrap	The focus-point display is bounded by the outermost focus points so that, for example, pressing  when a focus point at the right edge of the display is selected has no effect.

a8: Number of Focus Points

MENU button →  Custom Settings menu

Choose the number of focus points available for manual focus-point selection.

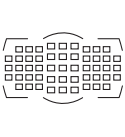
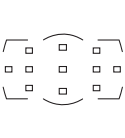
Option	Description	
AF51 51 points	Choose from the 51 focus points shown at right.	
AF11 11 points	Choose from the 11 focus points shown at right. Use for quick focus-point selection.	

a9: Store by Orientation

MENU button →  Custom Settings menu

Choose whether separate focus points can be selected for “wide” (landscape) orientation, for “tall” (portrait) orientation with the camera rotated 90° clockwise, and for “tall” orientation with the camera rotated 90° counterclockwise.

Select **Off** to use the same focus point and AF-area mode regardless of camera orientation.



Camera rotated 90°
counter-clockwise



Landscape (wide)
orientation



Camera rotated 90°
clockwise

Choose **Focus point** to enable separate focus-point selection, or **Focus point and AF-area mode** to enable separate selection of both the focus point and the AF-area mode.



Camera rotated 90°
counter-clockwise

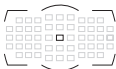

Landscape (wide)
orientation

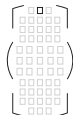

Camera rotated 90°
clockwise

a10: Built-in AF-assist Illuminator

MENU button →  Custom Settings menu

Choose whether the built-in AF-assist illuminator lights to assist the focus operation when lighting is poor.

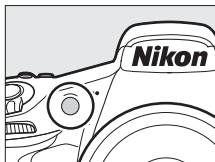

Option	Description
On	The AF-assist illuminator lights when lighting is poor (viewfinder photography only). AF-assist illumination is only available when both of the following conditions are met: 1 AF-S is selected for autofocus mode (□ 87). 2 Auto-area AF is chosen for AF-area mode (□ 90), or an option other than auto-area AF is chosen and the center focus point is selected.
Off	The AF-assist illuminator does not light to assist the focus operation. The camera may not be able to focus using autofocus when lighting is poor.

The AF-Assist Illuminator



The AF-assist illuminator has a range of about 0.5–3.0 m (1 ft 8 in.–9 ft 10 in.); when using the illuminator, remove the lens hood.

See Also

See page 425 for restrictions on the lenses that can be used with AF assist.

a11: Limit AF-Area Mode Selection

MENU button →  Custom Settings menu

Choose the AF-area modes that can be selected using the AF-mode button and sub-command dial in viewfinder photography (live view is unaffected;  90). Highlight the desired modes and press  to select or deselect. Press  to save changes when settings are complete.

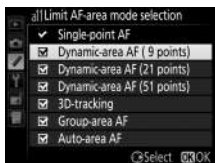

a12: Autofocus Mode Restrictions

MENU button →  Custom Settings menu

Choose the autofocus modes available in viewfinder photography ( 87). If only one mode is selected, the autofocus mode can not be chosen using the AF-mode button and main command dial.

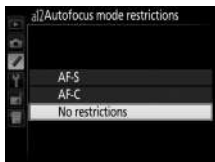

b: Metering/Exposure

b1: ISO Sensitivity Step Value

MENU button →  Custom Settings menu

Select the increments used when making adjustments to ISO sensitivity (📖 109). If possible, the current ISO sensitivity setting is maintained when the step value is changed. If the current ISO sensitivity setting is not available at the new step value, ISO sensitivity will be rounded to the nearest available setting.

b2: EV Steps for Exposure Cntrl

MENU button →  Custom Settings menu

Select the increments used when making adjustments to shutter speed, aperture, and bracketing.

b3: Exp./Flash Comp. Step Value



MENU button →  Custom Settings menu

Select the increments used when making adjustments to exposure and flash compensation.

b4: Easy Exposure Compensation

MENU button →  Custom Settings menu

This option controls whether the  button is needed to set exposure compensation (□ 130). If **On (Auto reset)** or **On** is selected, the 0 at the center of the exposure display will flash even when exposure compensation is set to ± 0 .

Option	Description
On (Auto reset)	Exposure compensation is set by rotating one of the command dials (see note below). The setting selected using the command dial is reset when the camera turns off or the standby timer expires (exposure compensation settings selected using the  button are not reset).
On	As above, except that the exposure compensation value selected using the command dial is not reset when the camera turns off or the standby timer expires.
Off	Exposure compensation is set by pressing the  button and rotating the main command dial.

Change Main/Sub

The dial used to set exposure compensation when **On (Auto reset)** or **On** is selected for Custom Setting b4 (**Easy exposure compensation**) depends on the option selected for Custom Setting f9 (**Customize command dials**) > **Change main/sub** (□ 351).

		Customize command dials > Change main/sub	
		Off	On
Exposure mode	P	Sub-command dial	Sub-command dial
	S	Sub-command dial	Main command dial
	A	Main command dial	Sub-command dial
	M	N/A	

Show ISO/Easy ISO

Custom Setting b4 (**Easy exposure compensation**) can not be used with Custom Setting d8 (**ISO display and adjustment**) > **Show ISO/Easy ISO** (📖 325). Adjustments to either of these items reset the remaining item; a message is displayed when the item is reset.

b5: Matrix Metering

MENU button →  Custom Settings menu

Choose  **Face detection on** to enable face detection when shooting portraits with matrix metering during viewfinder photography (📖 114).

b6: Center-Weighted Area

MENU button →  Custom Settings menu

When calculating exposure, center-weighted metering assigns the greatest weight to a circle in the center of the frame. The diameter (ϕ) of this circle can be set to 8, 12, 15, or 20 mm or to the average of the entire frame.



Note that when a non-CPU lens is used, the area assigned the greatest weight for center-weighted metering is equivalent to a circle with a diameter of 12 mm, regardless of the setting selected for **Non-CPU lens data** in the setup menu (📖 229).

b7: Fine-Tune Optimal Exposure

MENU button →  Custom Settings menu

Use this option to fine-tune the exposure value selected by the camera. Exposure can be fine-tuned separately for each metering method by from +1 to -1 EV in steps of $\frac{1}{6}$ EV.

Fine-Tuning Exposure

Exposure can be fine-tuned separately for each Custom Settings bank and is not affected by two-button resets. Note that as the exposure compensation () icon is not displayed, the only way to determine how much exposure has been altered is to view the amount in the fine-tuning menu. Exposure compensation ( 130) is preferred in most situations.

c: Timers/AE Lock

c1: Shutter-Release Button AE-L

MENU button →  Custom Settings menu

If **On** is selected, exposure will lock when the shutter-release button is pressed halfway.

c2: Standby Timer

MENU button →  Custom Settings menu



Choose how long the camera continues to meter exposure when no operations are performed. The shutter-speed and aperture displays in the control panel and viewfinder turn off automatically when the standby timer expires.

Choose a shorter standby timer delay for longer battery life.

c3: Self-Timer

MENU button →  Custom Settings menu

Choose the length of the shutter release delay, the number of shots taken, and the interval between shots in self-timer mode ( 106).

- **Self-timer delay:** Choose the length of the shutter-release delay.
- **Number of shots:** Press  and  to choose the number of shots taken each time the shutter-release button is pressed.
- **Interval between shots:** Choose the interval between shots when the **Number of shots** is more than 1.

c4: Monitor off Delay

MENU button →  Custom Settings menu



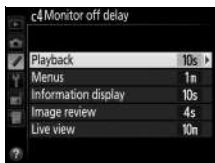

Choose how long the monitor remains on when no operations are performed during playback (**Playback**; defaults to 10 s) and image review (**Image review**; defaults to 4 s), when menus (**Menus**; defaults to 1 minute) or information (**Information display**; defaults to 10 s) are displayed, or during live view and movie recording (**Live view**; defaults to 10 minutes). Choose a shorter monitor-off delay for longer battery life.



d: Shooting/Display

d1: Beep

MENU button →  Custom Settings menu

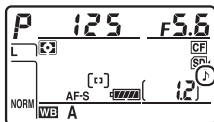

Choose the pitch and volume of the beep that sounds when the camera focuses using single-servo AF (**AF-S**;  87), when focus locks during live view photography, while the release timer is counting down in self-timer mode ( 106) when the shutter-release button is pressed a second time to take a picture in mirror-up mode ( 108), when time-lapse photography ends ( 223), or if you attempt to take a photograph when the memory card is locked ( 22).

- **Volume:** Choose **3** (high), **2** (medium), **1** (low) or **Off** (mute). When an option other than **Off** is selected,  appears in the control panel and information display.





- **Pitch:** Choose **High** or **Low**.

Beep

Note that regardless of the option selected, a beep will not sound when the camera focuses in movie live view ( 49) or quiet-shutter release mode (modes **Q** and **Qc**;  102).

d2: CL Mode Shooting Speed

MENU button →  Custom Settings menu

Choose the maximum frame advance rate in **CL** (continuous low speed) mode ( 104).

d3: Max. Continuous Release

MENU button →  Custom Settings menu

The maximum number of shots that can be taken in a single burst in continuous mode can be set to any value between 1 and 100. Note that this setting has no effect at shutter speeds of 4 s or slower.

The Memory Buffer

Regardless of the option selected for Custom Setting d3, shooting will slow when the memory buffer fills (). See page 489 for more information on the capacity of the memory buffer.

d4: Exposure Delay Mode

MENU button →  Custom Settings menu

In situations where the slightest camera movement can blur pictures, select **1 s**, **2 s**, or **3 s** to delay shutter release until one, two, or three seconds after the mirror is raised.

d5: Electronic Front-Curtain Shutter

MENU button →  Custom Settings menu

Select **Enable** to enable the electronic front-curtain shutter in **MUP** mode, eliminating blur caused by shutter motion. A mechanical shutter is used in other release modes.

The Electronic Front-Curtain Shutter

A type G, D, or E lens is recommended; select **Disable** if you notice lines or fog when shooting with other lenses. The fastest shutter speed available with the electronic front-curtain shutter is $\frac{1}{2000}$ s.

d6: File Number Sequence

MENU button →  Custom Settings menu

When a photograph is taken, the camera names the file by adding one to the last file number used. This option controls whether file numbering continues from the last number used when a new folder is created, the memory card is formatted, or a new memory card is inserted in the camera.

Option	Description
On	When a new folder is created, the memory card formatted, or a new memory card inserted in the camera, file numbering continues from the last number used or from the largest file number in the current folder, whichever is higher. If a photograph is taken when the current folder contains a photograph numbered 9999, a new folder will be created automatically and file numbering will begin again from 0001.
Off	File numbering is reset to 0001 when a new folder is created, the memory card is formatted, or a new memory card is inserted in the camera. Note that a new folder is created automatically if a photograph is taken when the current folder contains 999 photographs.
Reset	As for On , except that the next photograph taken is assigned a file number by adding one to the largest file number in the current folder. If the folder is empty, file numbering is reset to 0001.

File Number Sequence

If the current folder is numbered 999 and contains either 999 photographs or a photograph numbered 9999, the shutter-release button will be disabled and no further photographs can be taken. Choose **Reset** for Custom Setting d6 (**File number sequence**) and then either format the current memory card or insert a new memory card.

d7: Viewfinder Grid Display

MENU button →  Custom Settings menu

Choose **On** to display on-demand grid lines in the viewfinder for reference when composing photographs (📖 6).

d8: ISO Display and Adjustment

MENU button →  Custom Settings menu

If **Show ISO sensitivity** or **Show ISO/Easy ISO** is selected, the control panel will show ISO sensitivity in place of the number of exposures remaining. If **Show ISO/Easy ISO** is selected, ISO sensitivity can be set in exposure modes **P** and **S** by rotating the sub-command dial or in mode **A** by rotating the main command dial. Select **Show frame count** to display the number of exposures remaining in the viewfinder and control panel.

d9: Screen Tips

MENU button →  Custom Settings menu

Choose **On** to display tool tips for highlighted item in the **i**-button display during viewfinder photography (📖 205).

d10: Information Display

MENU button →  Custom Settings menu

If **Auto (AUTO)** is selected, the color of the lettering in the information display (☞ 201) will automatically change from black to white or white to black to maintain contrast with the background. To always use the same color lettering, select **Manual** and choose **Dark on light (B; black lettering)** or **Light on dark (W; white lettering)**. Monitor brightness will automatically be adjusted for maximum contrast with the selected text color.





Dark on light



Light on dark

d11: LCD Illumination



MENU button →  Custom Settings menu

If **Off** is selected, the control panel backlight (LCD illuminator) will only light while the power switch is rotated toward . If **On** is selected, the control panel will be illuminated whenever the standby timer is active (☞ 34). Select **Off** for increased battery life.

d12: MB-D12 Battery Type





MENU button →  Custom Settings menu

To ensure that the camera functions as expected when the optional MB-D12 battery pack is used with AA batteries, match the option selected in this menu to the type of batteries inserted in the battery pack. There is no need to adjust this option when using EN-EL15 or optional EN-EL18a/EN-EL18 batteries.

Option	Description
 LR6 (AA alkaline)	Select when using LR6 alkaline AA batteries.
 Ni-MH HR6 (AA Ni-MH)	Select when using HR6 Ni-MH AA batteries.
 FR6 (AA lithium)	Select when using FR6 lithium AA batteries.

Using AA Batteries

The capacity of AA batteries drops sharply at temperatures below 20 °C (68 °F) and varies with make and storage conditions; in some cases, batteries may cease to function before their expiry date. Some AA batteries can not be used; due to their performance characteristics and limited capacity, alkaline batteries have less capacity than some other types and should only be used if no alternative is available and then only at warmer temperatures. The camera shows the level of AA batteries as follows:

Control panel	Viewfinder	Description
	—	Batteries fully charged.
		Low battery. Ready fresh batteries.
 (flashes)	 (flashes)	Shutter release disabled. Change batteries.

d13: Battery Order

MENU button →  Custom Settings menu

Choose whether the battery in the camera or the batteries in the battery pack are used first when an optional MB-D12 battery pack is attached. Note that if the MB-D12 is powered by an optional AC adapter and power connector, the AC adapter will be used regardless of the option selected.

A  icon is displayed in the camera control panel when the batteries in the MB-D12 are in use.

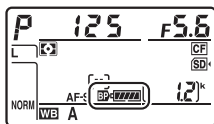



The MB-D12 Battery Pack

The MB-D12 takes one EN-EL15 or EN-EL18a/EN-EL18 rechargeable Li-ion battery or eight AA alkaline, Ni-MH, or lithium batteries (an EN-EL15 is supplied with the camera; EN-EL18a/EN-EL18 and AA batteries are available separately).

The information display shows the type of battery inserted in the MB-D12 as follows:



MB-D12 battery type display	Battery type
	EN-EL15 rechargeable Li-ion battery
	EN-EL18a/EN-EL18 rechargeable Li-ion battery
	AA batteries

e: Bracketing/Flash

e1: Flash Sync Speed

MENU button →  Custom Settings menu

This option controls flash sync speed.

Option	Description
1/320 s (Auto FP)	Auto FP high-speed sync is used when a compatible flash unit is attached (□ 430). If the built-in flash or other flash units are used, shutter speed is set to $\frac{1}{320}$ s. When the camera shows a shutter speed of $\frac{1}{320}$ s in exposure mode P or A , auto FP high-speed sync will be activated if the actual shutter speed is faster than $\frac{1}{320}$ s.
1/250 s (Auto FP)	Auto FP high-speed sync is used when a compatible flash unit is attached (□ 430). If the built-in flash or other flash units are used, shutter speed is set to $\frac{1}{250}$ s. When the camera shows a shutter speed of $\frac{1}{250}$ s in exposure mode P or A , auto FP high-speed sync will be activated if the actual shutter speed is faster than $\frac{1}{250}$ s.
1/250 s–1/60 s	Flash sync speed set to selected value.



Fixing Shutter Speed at the Flash Sync Speed Limit

To fix shutter speed at the sync speed limit in shutter-priority auto or manual exposure modes, select the next shutter speed after the slowest possible shutter speed (30 s or - -). An X (flash sync indicator) will be displayed in the viewfinder and control panel.

Auto FP High-Speed Sync

Allows the flash to be used at the highest shutter speed supported by the camera, making it possible to choose the maximum aperture for reduced depth of field even when the subject is backlit in bright sunlight. The information display flash mode indicator shows “FP” when auto FP high-speed sync is active (□ 194).

■ Auto FP High-Speed Sync

When **1/320 s (Auto FP)** or **1/250 s (Auto FP)** is selected for Custom Setting e1 (**Flash sync speed**,  329), the built-in flash can be used at shutter speeds as fast as $\frac{1}{320}$ s or $\frac{1}{250}$ s, while compatible optional flash units ( 430) can be used at any shutter speed (Auto FP High-Speed Sync).

Flash sync speed \ Shutter speed	1/320 s (Auto FP)		1/250 s (Auto FP)		1/250 s	
	Built-in flash	Optional flash unit	Built-in flash	Optional flash unit	Built-in flash	Optional flash unit
From $\frac{1}{8000}$ to but not including $\frac{1}{320}$ s	—	Auto FP	—	Auto FP	—	—
From $\frac{1}{320}$ to but not including $\frac{1}{250}$ s	Flash sync*		—	Auto FP	—	—
$\frac{1}{250}$ –30 s	Flash sync					

* Flash range drops as shutter speed increases. Flash range will nevertheless be greater than that obtained at the same speeds with Auto FP.

The Flash-Ready Indicator

When the flash fires at full power, the flash-indicator in the camera viewfinder will flash to warn that the resulting photograph may be underexposed. Note that the flash-ready indicators on optional flash units will not display this warning when **1/320 s (Auto FP)** is selected.

e2: Flash Shutter Speed





MENU button →  Custom Settings menu

This option determines the slowest shutter speed available when using front- or rear-curtain sync or red-eye reduction in programmed auto or aperture-priority auto exposure modes (regardless of the setting chosen, shutter speeds can be as slow as 30 s in shutter-priority auto and manual exposure modes or at flash settings of slow sync, slow rear-curtain sync, or red-eye reduction with slow sync).

e3: Flash Cntrl for Built-in Flash

MENU button →  Custom Settings menu





Choose the flash mode for the built-in flash.

Option	Description
TTL  TTL	Flash output is adjusted automatically in response to shooting conditions.
M  Manual	Choose the flash level. The camera does not emit monitor pre-flashes.
RPT  Repeating flash	The flash fires repeatedly while the shutter is open, producing a strobe-light effect.
CMD  Commander mode	Use the built-in flash as a master flash controlling remote optional flash units in one or more groups (□ 334).

Manual

Choose a flash level. Flash level is stated in fractions of full power: at full power, the built-in flash has a Guide Number of 12/39 (m/ft, ISO 100, 20 °C/68 °F).

Repeating Flash

The flash fires repeatedly while the shutter is open, producing a strobe-light effect. Press  or  to highlight the following options,  or  to change.



Option	Description
Output	Choose flash output (expressed as a fraction of full power).
Times	Choose the number of times the flash fires at the selected output. Note that depending on shutter speed and the option selected for Frequency , the actual number of flashes may be less than selected.
Frequency	Choose how often the flash fires per second.

Flash Control Mode

The flash control mode for the built-in flash is shown in the information display ( 194, 202).



“Manual” and “Repeating Flash”

 icons flash in the control panel and viewfinder when these options are selected.

🔍 The SB-400 and SB-300

When an optional SB-400 or SB-300 flash unit is attached and turned on, Custom Setting e3 changes to **Optional flash**, allowing the flash control mode for the optional flash unit to be selected from **TTL** and **Manual**.

🔍 “Times”

The options available for **Repeating Flash > Times** are determined by flash output.

Output	Options available for “Times”	Output	Options available for “Times”
1/4	2	1/32	2–10, 15
1/8	2–5	1/64	2–10, 15, 20, 25
1/16	2–10	1/128	2–10, 15, 20, 25, 30, 35

■ Commander Mode

Use the built-in flash as a master flash controlling one or more remote optional flash units in up to two groups (A and B) using advanced wireless lighting (📖 430).

Selecting this option displays the menu shown at right. Press ⏪ or ⏩ to highlight the following options, ⬆ or ⬇ to change.



Option	Description
Built-in flash	Choose a flash mode for the built-in flash (commander flash).
TTL	i-TTL mode. Choose flash compensation from values between +3.0 and -3.0 EV in increments of 1/3 EV.
M	Choose the flash level.
--	The built-in flash does not fire, although remote flash units do. The built-in flash must be raised so that it can emit monitor pre-flashes.
Group A	Choose a flash mode for all flash units in group A.
TTL	i-TTL mode. Choose flash compensation from values between +3.0 and -3.0 EV in increments of 1/3 EV.
AA	Auto aperture (available only with compatible flash units; 📖 430). Choose flash compensation from values between +3.0 and -3.0 EV in increments of 1/3 EV.
M	Choose the flash level.
--	The flash units in this group do not fire.
Group B	Choose a flash mode for all flash units in group B. The options available are the same as those listed for Group A , above.
Channel	Choose from channels 1–4. All flash units in both groups must be set to the same channel.

Follow the steps below to take photographs in commander mode.

1 Adjust settings for the built-in flash.

Choose the flash control mode and output level for the built-in flash.

Note that output level can not be adjusted in -- mode.

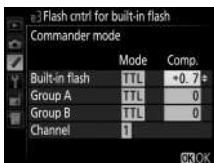

2 Adjust settings for group A.

Choose the flash control mode and output level for the flash units in group A.



3 Adjust settings for group B.

Choose the flash control mode and output level for the flash units in group B.



4 Select the channel.

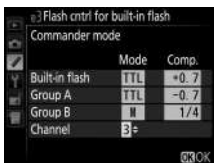

5 Press **OK**.

6 Compose the shot.

Compose the shot and arrange the flash units as shown below. Note that the maximum distance at which the remote flash units can be placed may vary with shooting conditions.

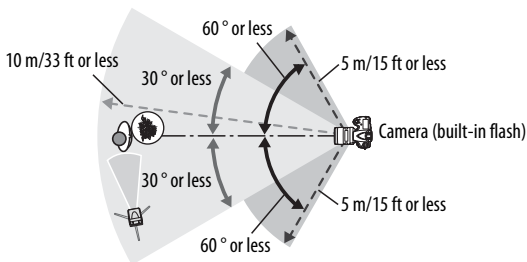

Wireless remote sensors on flash units should face camera.

7 Configure the remote flash units.

Turn all the remote flash units on, adjust group settings as desired, and set them to the channel selected in Step 4. See the flash unit instruction manuals for details.

8 Raise the built-in flash.

Press the flash pop-up button to raise the built-in flash. Note that even if – is selected for **Built-in flash > Mode**, the built-in flash must be raised so that monitor preflashes will be emitted.

9 Frame the photograph, focus, and shoot.

After confirming that the camera flash-ready light and the flash-ready lights for all other flash units are lit, frame the photograph, focus, and shoot. FV lock (📖 198) can be used if desired.

🔍 The Flash Sync Mode Display

⚡ does not appear in the control panel flash sync mode display when -- is selected for **Built-in flash > Mode**.

🔍 Flash Compensation

The flash compensation value selected with the ⚡ (🔍) button and sub-command dial is added to the flash compensation values selected for the built-in flash, group A, and group B in the **Commander mode** menu. A 🔍 icon is displayed in the control panel and viewfinder when a flash compensation value other than ± 0 is selected for **Built-in flash > TTL**. The 🔍 icon flashes when the built-in flash is in mode **M**.

🔍 Commander Mode



Position the sensor windows on the remote flash units to pick up the light from the built-in flash (particular care is required if the camera is not mounted on a tripod). Be sure that direct light or strong reflections from the remote flash units do not enter the camera lens (in TTL mode) or the photocells on the remote flash units (AA mode), as this may interfere with exposure. To prevent timing flashes emitted by the built-in flash from appearing in photographs taken at short range, choose low ISO sensitivities or small apertures (high f-numbers) or use an optional SG-3IR infrared panel for the built-in flash. An SG-3IR is required for best results with rear-curtain sync, which produces brighter timing flashes. After positioning the remote flash units, take a test shot and view the results in the camera monitor.

Although there is no limit on the number of remote flash units that may be used, the practical maximum is three. With more than this number, the light emitted by the remote flash units will interfere with performance.

e4: Exposure Comp. for Flash

MENU button →  Custom Settings menu

Choose how the camera adjusts flash level when exposure compensation is used.

Option	Description
 Entire frame	Both flash level and exposure compensation are adjusted to modify exposure over the entire frame.
 Background only	Exposure compensation applies to background only.

e5: Modeling Flash

MENU button →  Custom Settings menu

If **On** is selected when the camera is used with the built-in flash or an optional flash unit that supports the Nikon Creative Lighting system (□ 428), a modeling flash will be emitted when the camera **Pv** button is pressed (□ 117). No modeling flash is emitted if **Off** is selected.

e6: Auto Bracketing Set





MENU button →  Custom Settings menu

Choose the setting or settings bracketed when auto bracketing (□ 133) is in effect. Choose **AE & flash** (AE \updownarrow) to perform both exposure and flash-level bracketing, **AE only** (AE) to bracket only exposure, **Flash only** (⚡) to perform only flash-level bracketing, **WB bracketing** (WB) to perform white balance bracketing (□ 139), or **ADL bracketing** (ADL) to perform bracketing using Active D-Lighting (□ 143). Note that white balance bracketing is not available at image quality settings of NEF (RAW) or NEF (RAW) + JPEG.

e7: Auto Bracketing (Mode M)

MENU button →  Custom Settings menu

This option determines which settings are affected when **AE & flash** or **AE only** is selected for Custom Setting e6 in manual exposure mode.

Option	Description
 Flash/speed	Camera varies shutter speed (Custom Setting e6 set to AE only) or shutter speed and flash level (Custom Setting e6 set to AE & flash).
 Flash/speed/aperture	Camera varies shutter speed and aperture (Custom Setting e6 set to AE only) or shutter speed, aperture, and flash level (Custom Setting e6 set to AE & flash).
 Flash/aperture	Camera varies aperture (Custom Setting e6 set to AE only) or aperture and flash level (Custom Setting e6 set to AE & flash).
 Flash only	Camera varies flash level only (Custom Setting e6 set to AE & flash).

Flash bracketing is performed only with i-TTL or AA flash control. If a setting other than **Flash only** is selected and the flash is not used, ISO sensitivity will be fixed at the value for the first shot, regardless of the setting selected for auto ISO sensitivity control (📖 111).

e8: Bracketing Order

MENU button →  Custom Settings menu





At the default setting of **MTR > under > over** (☒), exposure, flash, and white balance bracketing are performed in the order described on pages 135 and 140. If **Under > MTR > over** (→+) is selected, shooting will proceed in order from the lowest to the highest value. This setting has no effect on ADL bracketing.

f: Controls

f1: Switch

MENU button →  Custom Settings menu

Choose what happens when the power switch is rotated to .





Option	Description
 LCD backlight ()	Control panel backlight illuminates for 6 s.
   and information display	Control panel backlight illuminates and shooting information is displayed in monitor.

f2: Multi Selector Center Button







MENU button →  Custom Settings menu

This option determines the role assigned to the center of the multi selector during viewfinder photography, playback, and live view (regardless of the option selected, pressing the center of the multi selector when a movie is displayed full frame starts movie playback).

■ Shooting Mode

Option	Role assigned to center of multi selector
 Select center focus point	Select the center focus point.
 Preset focus point	Pressing the center of the multi selector selects a preset focus point. To choose the point, select it and press the center of the multi selector while pressing the AF-mode button until the focus point flashes. Separate focus points can be selected for “wide” (landscape) orientation and for each of the two “tall” (portrait) orientations if Focus point or Focus point and AF-area mode is selected for Custom Setting a9 (Store by orientation ,  312).
 Highlight active focus point	Highlight the active focus point.
None	Pressing the center of the multi selector has no effect in viewfinder photography.

■ Playback Mode

Option	Role assigned to center of multi selector
 Thumbnail on/off	Toggle between full-frame and thumbnail playback.
 View histograms	In both full-frame and thumbnail playback, a histogram is displayed while the center of the multi selector is pressed ( 242).
 Zoom on/off	Toggle between full-frame or thumbnail playback and playback zoom. Choose the initial zoom setting from Low magnification (50%) , 1 : 1 (100%) , and High magnification (200%) . The zoom display will center on the active focus point.
 Choose slot and folder	Display the slot and folder selection dialog ( 237).

Live View

Option	Role assigned to center of multi selector
RESET Select center focus point	Pressing the center of the multi selector in live view selects the center focus point.
🔍 Zoom on/off	Press the center of the multi selector to toggle zoom on and off. Choose the initial zoom setting from Low magnification (50%) , 1 : 1 (100%) , and High magnification (200%) . The zoom display will center on the active focus point.
None	Pressing the center of the multi selector has no effect in live view.

f3: Multi Selector

MENU button →  Custom Settings menu

If **Restart standby timer** is selected, operating the multi selector when the standby timer expires (📖 34) will activate the exposure meters and start the standby timer. If **Do nothing** is selected, the timer will not start when the multi selector is pressed.

f4: Assign Fn Button





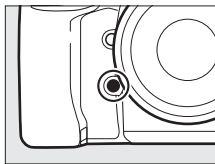



MENU button →  Custom Settings menu







Choose the role played by the **Fn** button, either by itself (**Press**) or when used in combination with the command dials (**Press + command dials**).











■ Press

Selecting **Press** displays the following options:

Option	Description
 Preview	During viewfinder photography, you can preview depth of field while the Fn button is pressed (□ 117). During live view photography, you can press the button once to open the lens to maximum aperture, making it easier to check focus; pressing the button again restores aperture to its original value (□ 41).
 FV lock	Press the Fn button to lock flash value (built-in flash and compatible optional flash units only, □ 198, 430). Press again to cancel FV lock.
 AE/AF lock	Focus and exposure lock while the Fn button is pressed.
 AE lock only	Exposure locks while the Fn button is pressed.
 AE lock (Reset on release)	Exposure locks when the Fn button is pressed, and remains locked until the button is pressed a second time, the shutter is released, or the standby timer expires.
 AE lock (Hold)	Exposure locks when the Fn button is pressed, and remains locked until the button is pressed a second time or the standby timer expires.
 AF lock only	Focus locks while the Fn button is pressed.
 AF-ON	Pressing the Fn button initiates autofocus.
 Disable/enable	If the flash is currently off, front-curtain sync will be selected while the Fn button is pressed. If the flash is currently enabled, it will instead be disabled while the Fn button is pressed.

Option	Description
BKT  Bracketing burst	If the Fn button is pressed while exposure, flash, or ADL bracketing is active in single frame or quiet shutter-release mode, all shots in the current bracketing program will be taken each time the shutter-release button is pressed. If white balance bracketing is active or continuous release mode (mode Ch , CL or Qc) is selected, the camera will repeat the bracketing burst while the shutter-release button is held down.
+RAW  + NEF (RAW)	If image quality is set to JPEG fine , JPEG normal , or JPEG basic , "RAW" will be displayed in the control panel and an NEF (RAW) copy will be recorded with the next picture taken after the Fn button is pressed (the original image quality setting will be restored when you remove your finger from the shutter-release button). NEF (RAW) copies are recorded at the settings currently selected for NEF (RAW) recording in the shooting menu (p. 295). To exit without recording an NEF (RAW) copy, press the Fn button again.
 Matrix metering	Matrix metering is activated while the Fn button is pressed.
 Center-weighted metering	Center-weighted metering is activated while the Fn button is pressed.
 Spot metering	Spot metering is activated while the Fn button is pressed.
 * Highlight-weighted metering	Highlight-weighted metering is activated while the Fn button is pressed.

Option	Description
 Viewfinder grid display	Press the Fn button to turn the framing grid display in the viewfinder on or off (□ 6).
 Viewfinder virtual horizon	Press the Fn button to view a virtual horizon display in the viewfinder (□ 347).
 Disable synchronized release	Keep the Fn button pressed to take photographs with the master camera only when using a wireless remote controller for remote synchronized release.
 Remote release only	Keep the Fn button pressed to take photographs with the remote cameras only when using a wireless remote controller for remote synchronized release.
 MY MENU	Pressing the Fn button displays “MY MENU” (□ 414).
 Access top item in MY MENU	Press the Fn button to jump to the top item in “MY MENU.” Select this option for quick access to a frequently-used menu item.
 Playback	Fn button performs same function as  button. Select when using a telephoto lens or in other circumstances in which it is difficult to operate the  button with your left hand.
None	Pressing the button has no effect.







Incompatible Options

If the option selected for **Press** can not be used in combination with the option selected for **Press + command dials**, a message will be displayed and whichever of **Press** or **Press + command dials** was selected first will be set to **None**.





Virtual Horizon

When **Viewfinder virtual horizon** is selected for f4 (**Assign Fn button**) > **Press**, pressing the Fn button displays a pitch and roll indicators in the viewfinder. Press the button a second time to return to clear the indicators from display.

Roll

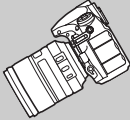
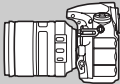
Camera tilted right	Camera level	Camera tilted left
		
		









Pitch

Camera tilted forward	Camera level	Camera tilted back
		
		

Note that the display may not be accurate when the camera is tilted at a sharp angle forward or back.

■ Press + Command Dials

Selecting **Press + command dials** displays the following options:

Option	Description
 Choose image area	<p>Press the Fn button and rotate a command dial to choose from pre-selected image areas (□ 74). Selecting Choose image area displays a list of image areas; highlight options and press  to select or deselect, then press .</p> 
 Shutter spd & aperture lock	<p>Press the Fn button and rotate the main command dial to lock shutter speed in modes S and M; press the Fn button and rotate the sub-command dial to lock aperture in modes A and M. See page 126 for more information.</p>
 1 step spd/aperture	<p>If the Fn button is pressed when the command dials are rotated, changes to shutter speed (exposure modes S and M) and aperture (exposure modes A and M) are made in increments of 1 EV, regardless of the option selected for Custom Setting b2 (EV steps for exposure cntrl, □ 315).</p>
 Choose non-CPU lens number	<p>Press the Fn button and rotate a command dial to choose a lens number specified using the Non-CPU lens data option (□ 229).</p>
 Active D-Lighting	<p>Press the Fn button and rotate the command dials to adjust Active D-Lighting (□ 182).</p>
 Exposure delay mode	<p>Press the Fn button and rotate a command dial to choose an exposure delay mode (□ 322).</p>
None	<p>No operation is performed when the command dials are rotated while the Fn button is pressed.</p>

f5: Assign Preview Button

MENU button →  Custom Settings menu

Choose the role played by the **Pv** button, either by itself (**Press**) or when used in combination with the command dials (**Press + command dials**). The options available are the same as for **Assign Fn button** (📖 343). The default options for **Press** and **Press + command dials** are **Preview** and **None**, respectively.



f6: Assign AE-L/AF-L button

MENU button →  Custom Settings menu

Choose the role played by the ^{AE-L}/_{AF-L} **AE-L/AF-L** button, either by itself (**Press**) or when used in combination with the command dials (**Press + command dials**). The options available are the same as for **Assign Fn button** (📖 343), except that **1 step spd/aperture** and **Active D-Lighting** are not available. The default options for **Press** and **Press + command dials** are **AE/AF lock** and **None**, respectively.

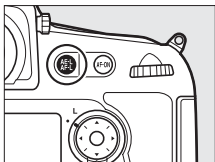

f7: Shutter Spd & Aperture Lock

MENU button →  Custom Settings menu

Selecting **On** for **Shutter speed lock** locks shutter speed at the value currently selected in mode **S** or **M**. Selecting **On** for **Aperture lock** locks aperture at the value currently selected in mode **A** or **M**. Shutter speed and aperture lock are not available in mode **P**.

f8: Assign BKT Button

MENU button →  Custom Settings menu

Choose the role played by the **BKT** button. If high dynamic range or multiple exposure is active while another function is assigned to the **BKT** button, the **BKT** button can not be used until high dynamic range or multiple exposure photography ends.

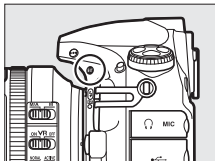





Option	Description
BKT Auto bracketing	Press the BKT button and rotate the command dials to choose the bracketing increment and number of shots in the bracketing sequence (☞ 133).
 Multiple exposure	Press the BKT button and rotate the command dials to choose the mode and number of shots for multiple exposures (☞ 211).
HDR HDR (high dynamic range)	Press the BKT button and rotate the command dials to choose the mode and the exposure differential (☞ 184).

f9: Customize Command Dials

MENU button →  Custom Settings menu

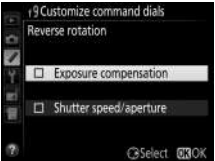
This option controls the operation of the main and sub-command dials.





Option	Description
Reverse rotation	<p>Reverse the direction of rotation of the command dials when they are used to make adjustments to Exposure compensation and/or Shutter speed/aperture. Highlight options and press  to select or deselect, then press .</p> <p>This setting also applies to the command dials for optional MB-D12 multi-power battery packs.</p> 
Change main/sub	<p>Exposure setting: If Off is selected, the main command dial controls shutter speed and the sub-command dial controls aperture. If On is selected, the main command dial will control aperture and the sub-command dial shutter speed. If On (Mode A) is selected, the main command dial will be used to set aperture in exposure mode A only.</p> <p>Autofocus setting: If On is selected, autofocus mode can be selected by keeping the AF-mode button pressed and rotating the sub-command dial, AF-area mode by keeping the AF-mode button pressed and rotating the main command dial.</p> <p>These settings also apply to the command dials for the MB-D12.</p>

Option	Description
Aperture setting	If Sub-command dial is selected, aperture can only be adjusted with the sub-command dial (or with the main command dial if On is selected for Change main/sub > Exposure setting). If Aperture ring is selected, aperture can only be adjusted with the lens aperture ring and the camera aperture display will show aperture in increments of 1 EV (aperture for type G and E lenses is still set using the sub-command dial). Note that regardless of the setting chosen, the aperture ring must be used to adjust aperture when a non-CPU lens is attached.
Menus and playback	If Off is selected, the multi selector is used to choose the picture displayed during full-frame playback, highlight thumbnails, and navigate menus. If On or On (image review excluded) is selected, the main command dial can be used to choose the picture displayed during full-frame playback, move the cursor left or right during thumbnail playback, and move the menu highlight bar up or down. The sub-command dial is used in full-frame playback to skip forward or back according to the option selected for Sub-dial frame advance and in thumbnail playback to page up or down. While menus are displayed, rotating the sub-command dial right displays the sub-menu for the selected option, while rotating it left displays the previous menu. To make a selection, press  , the center of the multi selector, or  . Select On (image review excluded) to prevent the command dials from being used for playback during image review.
Sub-dial frame advance	When On or On (image review excluded) is selected for Menus and playback , the sub-command dial can be rotated during full-frame playback to select a folder or to skip forward or back 10 or 50 frames at a time.

f10: Release Button to Use Dial

MENU button →  Custom Settings menu

Selecting **Yes** allows adjustments that are normally made by holding a button and rotating a command dial to be made by rotating the command dial after the button is released. Setting ends when the button is pressed again, the shutter-release button is pressed halfway, or the standby timer expires. This option is available with the following buttons:

Button		Button	
MODE (PRIORITY) button	116	 button	115
 button	131	AF mode button	39, 41, 88, 91
 (AE-L) button	190	Fn button ¹	348
BKT button	134, 139, 143	Pv button ²	349
ISO button	109	<small>AE-L</small> <small>AF-L</small> AE-L/AF-L button ³	349
QUAL button	80, 84	Movie-record button ⁴	355
WB button	149, 153, 157, 159, 163		

- 1 When assigned Active D-Lighting or exposure delay mode using Custom Setting f4.
- 2 When assigned Active D-Lighting or exposure delay mode using Custom Setting f5.
- 3 When assigned exposure delay mode using Custom Setting f6.
- 4 When assigned white balance or ISO sensitivity using Custom Setting f13.



f11: Slot Empty Release Lock

MENU button →  Custom Settings menu

Selecting **Enable release** allows the shutter to be released when no memory card is inserted, although no pictures will be recorded (they will however be displayed in the monitor in demo mode). If **Release locked** is selected, the shutter-release button is only enabled when a memory card is inserted in the camera.

f12: Reverse Indicators

MENU button →  Custom Settings menu

If  is selected, the exposure indicators in the control panel, viewfinder, and information display are displayed with negative values on the left and positive values on the right. Select  to display positive values on the left and negative values on the right.

f13: Assign Movie Record Button



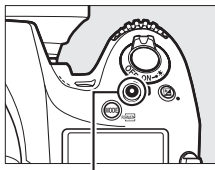

MENU button →  Custom Settings menu

Choose the role played by the movie-record button during viewfinder photography and live view photography.





Movie-record button

■ ■ Press + Command Dials

Option	Description
WB White balance	Press the button and rotate a command dial to choose a white balance option (□ 148).
ISO ISO sensitivity	Press the button and rotate a command dial to choose an ISO sensitivity (□ 109).
 Choose image area	Press the button and rotate a command dial to choose from pre-selected image areas (□ 74). Selecting Choose image area displays a list of image areas; highlight options and press  to select or deselect, then press  .
 Shutter spd & aperture lock	Press the button and rotate the main command dial to lock shutter speed in modes S and M ; press the button and rotate the sub-command dial to lock aperture in modes A and M . See page 126 for more information.
None	No operation is performed if the command dials are rotated while the button is pressed.

f14: Live View Button Options

MENU button →  Custom Settings menu

Select **Disable** to disable the  button, preventing live view from starting accidentally.

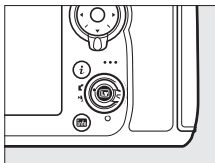







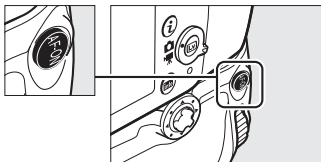

f15: Assign MB-D12 AF-ON

MENU button →  Custom Settings menu

Choose the function assigned to the **AF-ON** button on the optional MB-D12 battery pack.



Option	Description
 AF-ON	Pressing the MB-D12 AF-ON button initiates autofocus.
 AF lock only	Focus locks while the MB-D12 AF-ON button is pressed.
 AE/AF lock	Focus and exposure lock while the MB-D12 AF-ON button is pressed.
 AE lock only	Exposure locks while the MB-D12 AF-ON button is pressed.
 AE lock (Reset on release)	Exposure locks when the MB-D12 AF-ON button is pressed, and remains locked until the button is pressed a second time, the shutter is released, or the standby timer expires.



Option	Description
 AE lock (Hold)	Exposure locks when the MB-D12 AF-ON button is pressed, and remains locked until the button is pressed a second time or the standby timer expires.
 FV lock	Press the MB-D12 AF-ON button to lock flash value (built-in flash and compatible optional flash units only, □ 198 , 430). Press again to cancel FV lock.
 Same as Fn button	The MB-D12 AF-ON button performs the function selected for Custom Setting f4 (□ 343).







f16: Assign Remote (WR) Fn Button

MENU button →  Custom Settings menu

Choose the role played by the **Fn** button on the wireless remote controller.



Option	Description
 Preview	During viewfinder photography, you can preview depth of field while the Fn button is pressed (□ 117). During live view photography, you can press the button once to open the lens to maximum aperture, making it easier to check focus; pressing the button again restores aperture to its original value (□ 41).
 FV lock	Press the Fn button to lock flash value (built-in flash and compatible optional flash units only, □ 198 , 430). Press again to cancel FV lock.
 AE/AF lock	Focus and exposure lock while the Fn button is pressed.

Option	Description
 AE lock only	Exposure locks while the Fn button is pressed.
 AE lock (Reset on release)	Exposure locks when the Fn button is pressed, and remains locked until the button is pressed a second time, the shutter is released, or the standby timer expires.
 AF lock only	Focus locks while the Fn button is pressed.
 AF-ON	Pressing the Fn button initiates autofocus.
 Disable/enable	If the flash is currently off, front-curtain sync will be selected while the Fn button is pressed. If the flash is currently enabled, it will instead be disabled while the Fn button is pressed.
 + NEF (RAW)	If image quality is set to JPEG fine , JPEG normal , or JPEG basic , “RAW” will be displayed in the control panel and an NEF (RAW) copy will be recorded with the next picture taken after the Fn button is pressed (the original image quality setting will be restored when you remove your finger from the shutter-release button). NEF (RAW) copies are recorded at the settings currently selected for NEF (RAW) recording in the shooting menu (☐ 295). To exit without recording an NEF (RAW) copy, press the Fn button again.
 Live view	Pressing the Fn button starts and ends live view.
None	Pressing the button has no effect.

f17: Lens Focus Function Buttons

MENU button →  Custom Settings menu



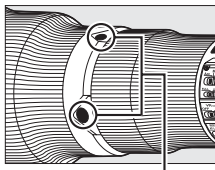

Choose the role played by the focus function buttons on the lens. The buttons can be used for the assigned function only when **AF-L** is selected with the focus function selector.





Focus function buttons



Focus function selector

Option	Description
 AF lock only	Focus locks while a focus function button is pressed.
 AE/AF lock	Focus and exposure lock while a focus function button is pressed.
 AE lock only	Exposure locks while a focus function button is pressed.
PRE ^[c2] Preset focus point	Keep a focus function button pressed to select a preset focus point (□ 342). Release the button to restore the original focus point selection.
[c3] AF-area mode	Highlight this option and press  to select an AF-area mode (3D-tracking excluded; □ 90). The selected mode will take effect while a focus function button is pressed; releasing the button restores the original AF-area mode. The lens focus function buttons can not be used to choose the AF-area mode during autofocus if 3D-tracking is selected using the controls on the camera.

Option	Description
 Disable/enable	If the flash is currently off, front-curtain sync will be selected while a focus function button is pressed. If the flash is currently enabled, it will instead be disabled while a focus function button is pressed.
 Disable synchronized release	Keep any of the focus function buttons pressed to take photographs with the master camera only when using a wireless remote controller for remote synchronized release.
 Remote release only	Keep any of the focus function buttons pressed to take photographs with the remote cameras only when using a wireless remote controller for remote synchronized release.



g: Movie

g1: Assign Fn Button

MENU button →  Custom Settings menu

Choose the role played by the **Fn** button during movie live view.

Press

Option	Description
 Power aperture (open)	Aperture widens while the button is pressed. Use in combination with Custom Setting g2 (Assign preview button) > Power aperture (close) for button-controlled aperture adjustment (□ 362).
 Index marking	Press the button during movie recording to add an index at the current position (□ 54). Indices can be used when viewing and editing movies.
 View photo shooting info	Press the button to display information on shutter speed, aperture, and other photo settings in place of movie recording information. Press again to return to the movie recording display.
None	Pressing the button has no effect.

Power Aperture



Power aperture is not available with some lenses. Power aperture is available only in exposure modes **A** and **M** and can not be used while photo shooting info is displayed (a  icon indicates that power aperture can not be used).

g2: Assign Preview Button

MENU button →  Custom Settings menu

Choose the role played by the **Pv** button during movie live view.

Press







Option	Description
 Power aperture (close)	Aperture narrows while the button is pressed. Use in combination with Custom Setting g1 (Assign Fn button) > Power aperture (open) for button-controlled aperture adjustment (□ 361).
 Index marking	Press the button during movie recording to add an index at the current position (□ 54). Indices can be used when viewing and editing movies.
 View photo shooting info	Press the button to display information on shutter speed, aperture, and other photo settings in place of movie recording information. Press again to return to the movie recording display.
None	Pressing the button has no effect.

g3: Assign AE-L/AF-L Button

MENU button →  Custom Settings menu

Choose the role played by the ^{AE-L}/_{AF-L} AE-L/AF-L button during movie live view.





Press

Option	Description
 Index marking	Press the button during movie recording to add an index at the current position (□ 54). Indices can be used when viewing and editing movies.
 View photo shooting info	Press the button to display information on shutter speed, aperture, and other photo settings in place of movie recording information. Press again to return to the movie recording display.
 AE/AF lock	Focus and exposure lock while the button is pressed.
 AE lock only	Exposure locks while the button is pressed.
 AE lock (Hold)	Exposure locks when the button is pressed, and remains locked until the button is pressed a second time.
 AF lock only	Focus locks while the button is pressed.
None	Pressing the button has no effect.

g4: Assign Shutter Button

MENU button →  Custom Settings menu

Choose the role played by pressing the shutter-release button when  is selected with the live view selector.

Option	Description
 Take photos	Press the shutter-release button all the way down to end movie recording and take a photograph with an aspect ratio of 16 : 9 (for information on image size, see page 60).
 Record movies	Press the shutter-release button halfway to start movie live view. You can then press the shutter-release button halfway to focus (autofocus mode only) and press it all the way down to start or end recording. The shutter-release button can not be used for other purposes during movie live view. To end movie live view, press the  button. The shutter-release button on an optional wireless remote controller or remote cord ( 439, 441) functions in the same way as the camera shutter-release button.

Y The Setup Menu: Camera Setup

To display the setup menu, press **MENU** and select the **Y** (setup menu) tab.



MENU button



Setup Menu Options

The setup menu contains the following options:

Option		Option	
Format memory card	366	Image comment	375
Monitor brightness	367	Copyright information	376
Monitor color balance	368	Save/load settings	377
Clean image sensor	445	Virtual horizon	379
Lock mirror up for cleaning ¹	448	Non-CPU lens data	229
Image Dust Off ref photo	369	AF fine-tune	380
Flicker reduction	371	HDMI	269
Time zone and date	372	Location data	234
Language	372	Network	261
Auto image rotation	373	Eye-Fi upload ²	382
Battery info	374	Firmware version	383

1 Not available when battery is low.

2 Only available when compatible Eye-Fi memory card is inserted.

See Also

Menu defaults are listed on page 279.

Format Memory Card

MENU button →  setup menu



Memory cards must be formatted before first use or after being used or formatted in other devices. *Note that formatting permanently deletes all pictures and other data on the card.* Before formatting, be sure to make backup copies as required ( 253).

During Formatting

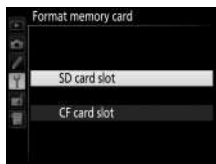

Do not turn the camera off or remove memory cards during formatting.

Selecting **Format memory card** in the setup menu displays the options shown at right; choose a memory card slot and select **Yes** to format the selected card.

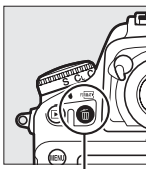

Memory cards can also be formatted by holding the  () and **MODE** () buttons down simultaneously until a flashing **For** appears in the shutter-speed displays in the control panel and viewfinder.



 () button

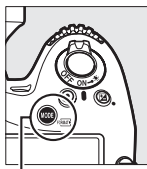

MODE () button

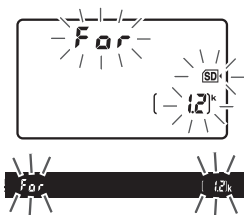



Press the buttons together again a second time to format the card (to exit without formatting the card, press any other button or wait for about six seconds until **F** **DIS** stops flashing). When formatting is complete, the control panel and viewfinder will show the number of photographs that can be recorded at current settings.

Two Memory Cards

If two memory cards are inserted when the  **FORMAT** and **MODE** **FORMAT** buttons are pressed, the card to be formatted will be shown by a flashing icon. Rotate the main command dial to choose a different slot.

Monitor Brightness

MENU button →  *setup menu*

Press  or  to choose monitor brightness for playback, menus, and the information display. Choose higher values for increased brightness, lower values for reduced brightness.

Monitor Brightness





Values of **+4** or higher make the monitor easier to read in bright light but also result in yellow colors taking on a greenish cast. Choose lower values for accurate color reproduction.

See Also

The option selected for **Monitor brightness** has no effect on the brightness of the display during live view photography or movie live view. For information on adjusting monitor brightness in live view, see page 42.

Monitor Color Balance

MENU button → Y setup menu

Use the multi selector as shown below to adjust monitor color balance with reference to a sample image. The sample image is the last photograph taken or, in playback mode, the last photograph displayed; to choose a different image, press the  button and select an image from a thumbnail list (to view the highlighted image full frame, press and hold ; to view images in other locations, press  and select the desired card and folder as described on page 237). If the memory card contains no photographs, an empty frame with a gray border will be displayed in place of the sample image. Press  to exit when adjustments are complete. Monitor color balance applies only to menus, playback, and the view through the lens displayed during live view photography and movie live view; pictures taken with the camera are not affected.

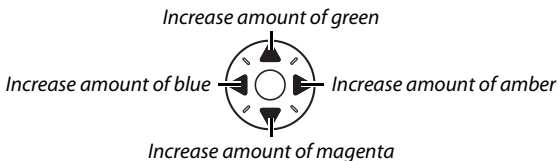



Image Dust Off Ref Photo

MENU button →  setup menu



Acquire reference data for the Image Dust Off option in Capture NX-D (available for download,  260; for more information, refer to Capture NX-D on-line help).

Image Dust Off ref photo is available only when a CPU lens is mounted on the camera. A non-DX lens with a focal length of at least 50 mm is recommended. When using a zoom lens, zoom all the way in.

1 Choose a start option.

Highlight one of the following options and press . To exit without acquiring image dust off data, press MENU.

- **Start:** The message shown at right will be displayed and “rEF” will appear in the viewfinder and control panel displays.
- **Clean sensor and then start:** Select this option to clean the image sensor before starting. The message shown at right will be displayed and “rEF” will appear in the viewfinder and control panel displays when cleaning is complete.



Image Sensor Cleaning

Dust off reference data recorded before image sensor cleaning is performed can not be used with photographs taken after image sensor cleaning is performed. Select **Clean sensor and then start** only if the dust off reference data will not be used with existing photographs.

2 Frame a featureless white object in the viewfinder.

With the lens about ten centimeters (four inches) from a well-lit, featureless white object, frame the object so that it fills the viewfinder and then press the shutter-release button halfway.

In autofocus mode, focus will automatically be set to infinity; in manual focus mode, set focus to infinity manually.

3 Acquire dust off reference data.

Press the shutter-release button the rest of the way down to acquire Image Dust Off reference data. The monitor turns off when the shutter-release button is pressed.

If the reference object is too bright or too dark, the camera may be unable to acquire Image Dust Off reference data and the message shown at right will be displayed. Choose another reference object and repeat the process from Step 1.



Image Dust Off Reference Data

The same reference data can be used for photographs taken with different lenses or at different apertures. Reference images can not be viewed using computer imaging software. A grid pattern is displayed when reference images are viewed on the camera.

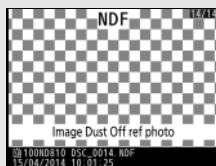

Flicker Reduction

MENU button →  setup menu

Reduce flicker and banding when shooting under fluorescent or mercury-vapor lighting during live view or movie recording. Choose **Auto** to allow the camera to automatically choose the correct frequency, or manually match the frequency to that of the local AC power supply.

Flicker Reduction



If **Auto** fails to produce the desired results and you are unsure as to the frequency of the local power supply, test both the 50 and 60 Hz options and choose the one that produces the best results. Flicker reduction may not produce the desired results if the subject is very bright, in which case you should try choosing a smaller aperture (higher f-number). To prevent flicker, select mode **M** and choose a shutter speed adapted to the frequency of the local power supply: $1/125$ s, $1/60$ s, or $1/30$ s for 60 Hz; $1/100$ s, $1/50$ s, or $1/25$ s for 50 Hz.

Time Zone and Date

MENU button →  setup menu

Change time zones, set the camera clock, choose the date display order, and turn daylight saving time on or off ( 18).

Option	Description
Time zone	Choose a time zone. The camera clock is automatically set to the time in the new time zone.
Date and time	Set the camera clock.
Date format	Choose the order in which the day, month, and year are displayed.
Daylight saving time	Turn daylight saving time on or off. The camera clock will automatically be advanced or set back one hour. The default setting is Off .

If the clock is reset, a  icon will flash in the control panel and a flashing  indicator will appear in the information display.

Language

MENU button →  setup menu

Choose a language for camera menus and messages.

Auto Image Rotation

MENU button → Y setup menu

Photographs taken while **On** is selected contain information on camera orientation, allowing them to be rotated automatically during playback (☞ 288) or when viewed in ViewNX 2 (supplied) or in Capture NX-D (available for download; ☞ 260). The following orientations are recorded:



*Landscape (wide)
orientation*



*Camera rotated 90°
clockwise*



*Camera rotated 90°
counter-clockwise*

Camera orientation is not recorded when **Off** is selected. Choose this option when panning or taking photographs with the lens pointing up or down.

Rotate Tall



To automatically rotate “tall” (portrait-orientation) photographs for display during playback, select **On** for the **Rotate tall** option in the playback menu (☞ 288).

Battery Info

MENU button →  setup menu

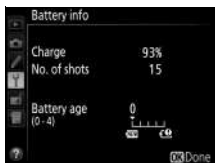
View information on the battery currently inserted in the camera.



Item	Description
Charge	The current battery level expressed as a percentage.
No. of shots	The number of times the shutter has been released with the current battery since the battery was last charged. Note that the camera may sometimes release the shutter without recording a photograph, for example when measuring preset manual white balance.
Calibration	<ul style="list-style-type: none">• This item is displayed only when the camera is powered by an optional MB-D12 battery pack equipped with an EN-EL18a/EN-EL18 (available separately).•  CAL: Due to repeated use and recharging, calibration is required to ensure that battery level can be measured accurately; recalibrate battery before charging.• —: Calibration not required.
Battery age	A five-level display showing battery age. 0 () indicates that battery performance is unimpaired, 4 () that the battery has reached the end of its charging life and should be replaced. Note that fresh batteries charged at temperatures under about 5 °C (41 °F) may show a temporary drop in charging life; the battery age display will however return to normal once the battery has been recharged at a temperature of about 20 °C (68 °F) or higher.

The MB-D12 Battery Pack

The display for the MB-D12 is shown at right. In the case of EN-EL18a/EN-EL18 batteries, the display shows whether calibration is required. If AA batteries are used, the battery level will be shown by a battery level icon; other items will not be displayed.

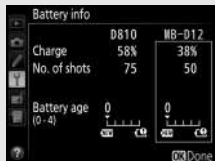





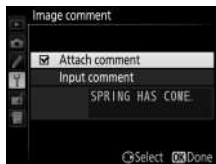

Image Comment

MENU button →  setup menu



Add a comment to new photographs as they are taken. Comments can be viewed as metadata in ViewNX 2 (supplied) or Capture NX-D (available for download;  260). The comment is also visible on the shooting data page in the photo information display ( 244). The following options are available:



- **Input comment:** Input a comment as described on page 178. Comments can be up to 36 characters long.
- **Attach comment:** Select this option to attach the comment to all subsequent photographs. **Attach comment** can be turned on and off by highlighting it and pressing . After choosing the desired setting, press  to exit.



Copyright Information

MENU button →  setup menu

Add copyright information to new photographs as they are taken. Copyright information is included in the shooting data shown in the photo information display ( 245) and can be viewed as metadata in ViewNX 2 (supplied) or in Capture NX-D (available for download;  260). The following options are available:

- **Artist:** Enter a photographer name as described on page 178. Photographer names can be up to 36 characters long.
- **Copyright:** Enter the name of the copyright holder as described on page 178. Copyright holder names can be up to 54 characters long.
- **Attach copyright information:** Select this option to attach copyright information to all subsequent photographs. **Attach copyright information** can be turned on and off by highlighting it and pressing . After choosing the desired setting, press  to exit.



Copyright Information

To prevent unauthorized use of the artist or copyright holder names, make sure that **Attach copyright information** is not selected and that the **Artist** and **Copyright** fields are blank before lending or transferring the camera to another person. Nikon does not accept liability for any damages or disputes arising from the use of the **Copyright information** option.

Save/Load Settings

MENU button →  setup menu

Select **Save settings** to save the following settings to the memory card, or to the memory card in the primary card slot if two memory cards are inserted (📖 86; if the card is full, an error will be displayed). Use this option to share settings among D810 cameras.

Menu	Option
Playback	Playback display options
	Image review
	After delete
	Rotate tall
Shooting (all banks)	Shooting menu bank
	Extended menu banks
	File naming
	Primary slot selection
	Secondary slot function
	Image quality
	JPEG/TIFF recording
	NEF (RAW) recording
	Image area
	White balance (with fine-tuning and presets d-1–d-6)
	Set Picture Control (Custom Picture Controls are saved as Standard)
	Color space
	Active D-Lighting
	Vignette control
Auto distortion control	
Long exposure NR	

Menu	Option
Shooting (all banks)	High ISO NR
	ISO sensitivity settings
	Movie settings
Custom settings (all banks)	All Custom Settings
Setup	Clean image sensor
	Flicker reduction
	Time zone and date (excepting date and time)
	Language
	Auto image rotation
	Image comment
	Copyright information
	Non-CPU lens data
	HDMI
	Location data
	Eye-Fi upload
My Menu/ Recent Settings	All My Menu items
	All recent settings
	Choose tab

Settings saved using this model of camera can be restored by selecting **Load settings**. Note that **Save/load settings** is only available when a memory card is inserted in the camera, and that the **Load settings** option is only available if the card contains saved settings.

Saved Settings

Settings are saved in a file named NCSETUPF. The camera will not be able to load settings if the file name is changed.

Virtual Horizon

MENU button →  setup menu

Display roll and pitch information based on information from the camera tilt sensor. If the camera is tilted neither left nor right, the roll reference line will turn green, while if the camera is tilted neither forward nor back, the dot in the center of the display will turn green. Each division is equivalent to about 5°.



Camera level



Camera tilted left or right

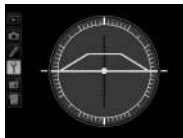

Camera tilted forward or back

Tilting the Camera

The virtual horizon display is not accurate when the camera is tilted at a sharp angle forward or back. If the camera is unable to measure tilt, the amount of tilt will not be displayed.



See Also





For information on viewing a virtual horizon display in the viewfinder, see Custom Setting f4 (**Assign Fn button > Press**;  343, 347). For information on displaying a virtual horizon in live view, see pages 46 and 58.

AF Fine-Tune

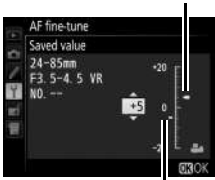
MENU button → Y setup menu

Fine-tune focus for up to 20 lens types. AF tuning is not recommended in most situations and may interfere with normal focus; use only when required.

Option	Description
AF fine-tune (On/Off)	<ul style="list-style-type: none">• On: Turn AF tuning on.• Off: Turn AF tuning off.
Saved value	<p>Tune AF for the current lens (CPU lenses only). Press  or  to choose a value between +20 and -20. Values for up to 20 lens types can be stored. Only one value can be stored for each type of lens.</p> <p><i>Move focal point away from camera.</i> <i>Current value</i></p>  <p><i>Move focal point toward camera.</i> <i>Previous value</i></p>
Default	<p>Choose the AF tuning value used when no previously saved value exists for the current lens (CPU lenses only).</p>

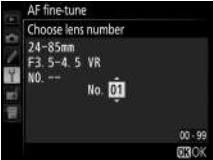
Option	Description
<p>List saved values</p>	<p>List previously saved AF tuning values. To delete a lens from the list, highlight the desired lens and press  (FORMAT). To change a lens identifier (for example, to choose an identifier that is the same as the last two digits of the lens serial number to distinguish it from other lenses of the same type in light of the fact that Saved value can be used with only one lens of each type), highlight the desired lens and press .</p> <p>The menu shown at right will be displayed; press  or  to choose an identifier and press  to save changes and exit.</p> 

AF Tuning

The camera may be unable to focus at minimum range or at infinity when AF tuning is applied.

Live View

Tuning is not applied to autofocus during live view ( 35).

Saved Value

Only one value can be stored for each type of lens. If a teleconverter is used, separate values can be stored for each combination of lens and teleconverter.

Eye-Fi Upload

MENU button →  setup menu

This option is displayed only when an Eye-Fi memory card (available separately from third-party suppliers) is inserted in the camera. Choose **Enable** to upload photographs to a preselected destination. Note that pictures will not be uploaded if signal strength is insufficient.

Observe all local laws concerning wireless devices and choose **Disable** where wireless devices are prohibited.







Eye-Fi Cards

Eye-Fi cards may emit wireless signals when **Disable** is selected. If a warning is displayed in the monitor ( 470), turn the camera off and remove the card.

Set Custom Setting c2 (**Standby timer**,  319) to 30 s or more when using an Eye-Fi card.

See the manual provided with the Eye-Fi card, and direct any inquiries to the manufacturer. The camera can be used to turn Eye-Fi cards on and off, but may not support other Eye-Fi functions.

When an Eye-Fi card is inserted, its status is indicated by an icon in the information display:

- : Eye-Fi upload disabled.
- : Eye-Fi upload enabled but no pictures available for upload.
-  (static): Eye-Fi upload enabled; waiting to begin upload.
-  (animated): Eye-Fi upload enabled; uploading data.
- : Error — camera can not control Eye-Fi card. If a flashing  appears in the control panel or viewfinder, refer to page 470; if this indicator is not flashing, pictures can be taken normally but you may be unable to change Eye-Fi settings.



Supported Eye-Fi Cards

Some cards may not be available in some countries or regions; consult the manufacturer for more information. Eye-Fi cards are for use only in the country of purchase. Be sure the Eye-Fi card firmware has been updated to the latest version.

Firmware Version

MENU button →  setup menu

View the current camera firmware version.























The Retouch Menu: Creating Retouched Copies



To display the retouch menu, press **MENU** and select the  (retouch menu) tab.



Retouch Menu Options

The options in the retouch menu are used to create trimmed, or retouched copies of existing pictures. The retouch menu is only displayed when a memory card containing photographs other than small NEF (RAW) images is inserted in the camera.

Option		Option	
 D-Lighting	388	 Straighten	404
 Red-eye correction	389	 Distortion control	405
 Trim	390	 Fisheye	406
 Monochrome	392	 Color outline	406
 Filter effects	393	 Color sketch	407
 Color balance	394	 Perspective control	408
 Image overlay¹	395	 Miniature effect	409
 NEF (RAW) processing	399	 Selective color	410
 Resize	401	 Edit movie	67
 Quick retouch	404	 Side-by-side comparison²	412

- 1 Can only be selected by pressing **MENU** and selecting  tab.
- 2 Available only if  button is pressed in full-frame playback when a retouched image or original is displayed.

Creating Retouched Copies

To create a retouched copy:

1 Select an item in the retouch menu.

Press or to highlight an item, to select.



2 Select a picture.

Highlight a picture and press . To view the highlighted picture full screen, press and hold the button.



To view images in other locations, press and select the desired card and folder as described on page 237.



Retouch

In the case of images recorded at image quality settings of NEF + JPEG, only the NEF (RAW) image will be retouched. The camera may not be able to display or retouch images created with other devices.



3 Select retouch options.

For more information, see the section for the selected item.
To exit without creating a retouched copy, press **MENU**.

Monitor off Delay

The monitor will turn off and the operation will be cancelled if no actions are performed for a brief period. Any unsaved changes will be lost. To increase the time the monitor remains on, choose a longer menu display time for Custom Setting c4 (**Monitor off delay**,  320).

4 Create a retouched copy.

Press  to create a retouched copy.
Retouched copies are indicated by a  icon.



Creating Retouched Copies During Playback

Retouched copies can also be created during playback.



Display picture full frame and press .



Highlight an option and press .



Create retouched copy.

✔ Small NEF (RAW) + JPEG Images

If the JPEG copies of small NEF (RAW) images taken at image quality settings of NEF (RAW) + JPEG are recorded to the same memory card (□ 86), neither the NEF (RAW) images nor the JPEG copies can be edited.

✔ Retouching Copies

Most options can be applied to copies created using other retouch options, although with the exceptions of **Image overlay** and **Edit movie > Choose start/end point** each option can be applied only once (note that multiple edits may result in loss of detail). Options that can not be applied to the current image can not be selected.

✔ Image Quality

Except in the case of copies created with **Trim**, **Image overlay**, **NEF (RAW) processing**, and **Resize**, copies created from JPEG images are the same size and quality as the original, copies created from NEF (RAW) photos are saved as large fine-quality JPEG images, and copies created from TIFF (RGB) photos are saved as fine-quality JPEG images of the same size as the original. Size-priority compression is used when copies are saved in JPEG format.

D-Lighting

MENU button →  retouch menu



D-Lighting brightens shadows, making it ideal for dark or backlit photographs.



Before



After









Press  or  to choose the amount of correction performed. The effect can be previewed in the edit display. Press  to save the retouched copy.



Red-Eye Correction

MENU button →  retouch menu

This option is used to correct “red-eye” caused by the flash and is available only with photographs taken using a flash. The photograph selected for red-eye correction can be previewed in the edit display. Confirm the effects of red-eye correction and create a copy as described in the following table. Note that red-eye correction may not always produce the expected results and may in very rare circumstances be applied to portions of the image that are not affected by red-eye; check the preview thoroughly before proceeding.









To	Use	Description
Zoom in		Press  to zoom in,  to zoom out. While photo is zoomed in, use multi selector to view areas of image not visible in monitor. Keep multi selector pressed to scroll rapidly to other areas of frame. Navigation window is displayed when zoom buttons or multi selector are pressed; area currently visible in monitor is indicated by yellow border. Press  to cancel zoom.
Zoom out		
View other areas of image		
Cancel zoom		
Create copy		If the camera detects red-eye in the selected photograph, a copy will be created that has been processed to reduce its effects. No copy will be created if the camera is unable to detect red-eye.

Trim

MENU button →  retouch menu

Create a cropped copy of the selected photograph. The selected photograph is displayed with the selected crop shown in yellow; create a cropped copy as described in the following table.



To	Use	Description
Reduce size of crop		Press  to reduce the size of the crop.
Increase size of crop		Press  to increase the size of the crop.
Change crop aspect ratio		Rotate the main command dial to choose the aspect ratio.
Position crop		Use multi selector to position the crop. Press and hold to move the crop rapidly to the desired position.
Preview crop		Press center of multi selector to preview cropped image.
Create copy		Save the current crop as a separate file.

Trim: Image Quality and Size

Copies created from NEF (RAW), NEF (RAW) + JPEG, or TIFF (RGB) photos have an image quality (📖 79) of JPEG fine; cropped copies created from JPEG photos have the same image quality as the original. The size of the copy varies with crop size and aspect ratio and appears at upper left in the crop display.



Viewing Cropped Copies



Playback zoom may not be available when cropped copies are displayed.

Monochrome

MENU button →  retouch menu

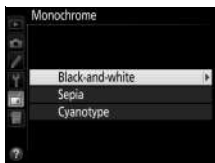
Copy photographs in **Black-and-white**, **Sepia**, or **Cyanotype** (blue and white monochrome).



Selecting **Sepia** or **Cyanotype** displays a preview of the selected image; press  to increase color saturation,  to decrease. Press  to create a monochrome copy.

Increase saturation









Decrease saturation





Filter Effects

MENU button →  retouch menu

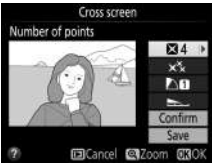

Choose from the following filter effects. After adjusting filter effects as described below, press  to save the retouched copy.

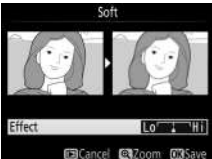
Option	Description	
Skylight	Creates the effect of a skylight filter, making the picture less blue. The effect can be previewed in the monitor as shown at right.	
Warm filter	Creates a copy with warm tone filter effects, giving the copy a "warm" red cast. The effect can be previewed in the monitor.	
Red intensifier	Intensify reds (Red intensifier), greens (Green intensifier), or blues (Blue intensifier). Press  to increase the effect,  to decrease.	
Green intensifier		
Blue intensifier		
Cross screen	Add starburst effects to light sources. <ul style="list-style-type: none">• Number of points: Choose from four, six, or eight.• Filter amount: Choose the brightness of the light sources affected.• Filter angle: Choose the angle of the points.• Length of points: Choose the length of points.• Confirm: Preview the effects of the filter. Press  to preview the copy full frame.• Save: Create a retouched copy.	

Option	Description
Soft	Add a soft filter effect. Press  or  to choose the filter strength. 

Color Balance

MENU button →  retouch menu

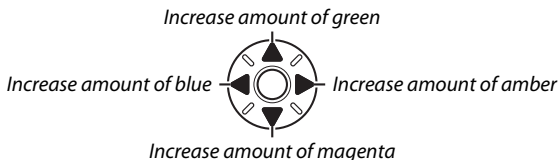
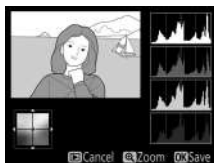

Use the multi selector to create a copy with modified color balance as shown below. The effect is displayed in the monitor together with red, green, and blue histograms ( 241) giving the distribution of tones in the copy. Press  to save the retouched copy.



Zoom

To zoom in on the image displayed in the monitor, press . The histogram will be updated to show data only for the portion of the image displayed in the monitor.

While the image is zoomed in, press

 (/?) to toggle back and forth between color balance and zoom. When



zoom is selected, you can zoom in and out with the  and  buttons and scroll the image with the multi selector.



Image Overlay



MENU button →  retouch menu

Image overlay combines two existing NEF (RAW) photographs to create a single picture that is saved separately from the originals; the results, which make use of RAW data from the camera image sensor, are noticeably better than photographs combined in an imaging application. The new picture is saved at current image quality and size settings; before creating an overlay, set image quality and size ( 79, 83; all options are available). To create a NEF (RAW) copy, choose an image quality of **NEF (RAW)** and an image size of **Large** (the overlay will be saved as a large NEF/RAW image even if **Small** is selected).



1 Select Image overlay.

Highlight **Image overlay** in the retouch menu and press . The dialog shown at right will be displayed, with **Image 1** highlighted; press to display a picture selection dialog listing only large NEF (RAW) images created with this camera (small NEF/RAW images can not be selected).



2 Select the first image.



Use the multi selector to highlight the first photograph in the overlay. To view the highlighted photograph full frame, press and hold the button. To view images in other locations, press and select the desired card and folder as described on page 237. Press to select the highlighted photograph and return to the preview display.



3 Select the second image.







The selected image will appear as **Image 1**. Highlight **Image 2** and press , then select the second photo as described in Step 2.

4 Adjust gain.

Highlight **Image 1** or **Image 2** and optimize exposure for the overlay by pressing  or  to select the gain from values between 0.1 and 2.0. Repeat for the second image. The default value is 1.0; select 0.5 to halve gain or 2.0 to double it. The effects of gain are visible in the **Preview** column.



5 Preview the overlay.

Press  or  to place the cursor in the **Preview** column and press  or  to highlight **Overlay**. Press  to preview the overlay as shown at right (to save the overlay without displaying a preview, select **Save**). To return to Step 4 and select new photos or adjust gain, press .



6 Save the overlay.

Press  while the preview is displayed to save the overlay. After an overlay is created, the resulting image will be displayed full-frame in the monitor.



Image Overlay

Only NEF (RAW) photographs with the same image area and bit depth can be combined.

The overlay has the same photo info (including date of recording, metering, shutter speed, aperture, exposure mode, exposure compensation, focal length, and image orientation) and values for white balance and Picture Control as the photograph selected for **Image 1**. The current image comment is appended to the overlay when it is saved; copyright information, however, is not copied.



Overlays saved in NEF (RAW) format use the compression selected for **NEF (RAW) compression** in the **NEF (RAW) recording** menu and have the same bit depth as the original images; JPEG overlays are saved using size-priority compression.

NEF (RAW) Processing

MENU button →  retouch menu



Create JPEG copies of NEF (RAW) photographs.

1 Select NEF (RAW) processing.

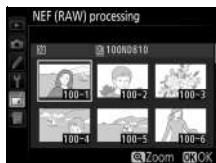
Highlight **NEF (RAW) processing** in the retouch menu and press  to display a picture selection dialog listing only large NEF (RAW) images created with this camera. Small NEF/RAW images can not be selected; to create JPEG copies of small NEF (RAW) images, use the supplied ViewNX 2 software ( 253) or Capture NX-D (available for download;  260).



2 Select a photograph.

Use the multi selector to highlight a photograph (to view the highlighted photograph full frame, press and hold the  button; to view images in other locations as described on page 237, press ). Press  to select the highlighted photograph and proceed to the next step.

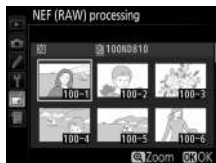

3 Choose settings for the JPEG copy.

Adjust the settings listed below. Note that white balance and vignette control are not available with multiple exposures or pictures created with image overlay and that exposure compensation can only be set to values between -2 and $+2$ EV.

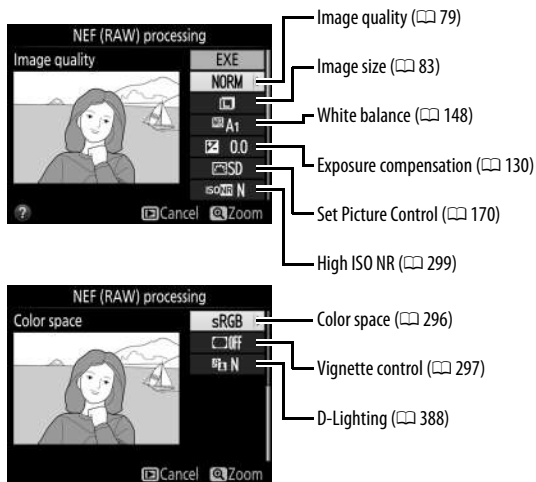

4 Copy the photograph.

Highlight **EXE** and press **OK** to create a JPEG copy of the selected photograph. To exit without copying the photograph, press the **MENU** button.



Resize

MENU button →  retouch menu

Create small copies of selected photographs.

1 Select **Resize**.

To resize selected images, highlight **Resize** in the retouch menu and press .



2 Choose a destination.

If two memory cards are inserted, you can choose a destination for the resized copies by highlighting **Choose destination** and pressing  (if only one memory card is inserted, proceed to Step 3).

The menu shown at right will be displayed; highlight a card slot and press .

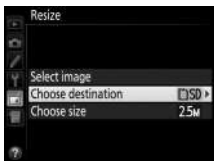

3 Choose a size.

Highlight **Choose size** and press .





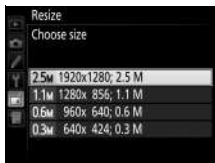



The options shown at right will be displayed; highlight an option and press .

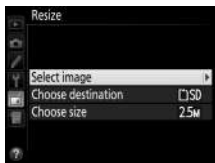

4 Choose pictures.

Highlight **Select image** and press .



Highlight pictures and press the center of the multi selector to select or deselect (to view the highlighted picture full screen, press and hold the  button; to view pictures in other locations as described on page 237, press ). Selected pictures are marked by a  icon. Press  when the selection is complete. Note that photographs taken at an image-area setting of 5 : 4 ( 75) can not be resized.



5 Save the resized copies.

A confirmation dialog will be displayed. Highlight **Yes** and press **OK** to save the resized copies.



🔍 Viewing Resized Copies

Playback zoom may not be available when resized copies are displayed.



🔍 Image Quality

Copies created from NEF (RAW), NEF (RAW) + JPEG, or TIFF (RGB) photos have an image quality (📄 79) of JPEG fine; copies created from JPEG photos have the same image quality as the original.

Quick Retouch

MENU button →  retouch menu

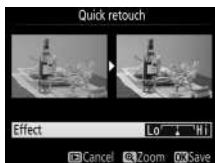

Create copies with enhanced saturation and contrast. D-Lighting is applied as required to brighten dark or backlit subjects.

Press  or  to choose the amount of enhancement. The effect can be previewed in the edit display. Press  to save the retouched copy.



Straighten

MENU button →  retouch menu

Create a straightened copy of the selected image. Press  to rotate the image clockwise by up to five degrees in increments of approximately 0.25 degrees,  to rotate it counterclockwise (the effect can be previewed in the edit display; note that edges of the image will be trimmed to create a square copy). Press  to save the retouched copy.





Distortion Control

MENU button →  retouch menu

Create copies with reduced peripheral distortion. Select **Auto** to let the camera correct distortion automatically and then make fine adjustments using the multi selector, or select **Manual** to reduce distortion manually (note that





Auto is not available with photos taken using auto distortion control; see page 298). Press  to reduce barrel distortion,  to reduce pin-cushion distortion (the effect can be previewed in the edit display; note that greater amounts of distortion control result in more of the edges being cropped out). Press  to save the retouched copy. Note that distortion control may heavily crop or distort the edges of copies created from photographs taken with DX lenses at image areas other than **DX (24×16)**.

Auto

Auto is for use only with pictures taken with type G, E, and D lenses (PC, fisheye, and certain other lenses excluded). Results are not guaranteed with other lenses.

Fisheye

MENU button →  retouch menu

Create copies that appear to have been taken with a fisheye lens. Press  to increase the effect (this also increases the amount that will be cropped out at the edges of the image),  to reduce it. The effect can be previewed in the edit display. Press  to save the retouched copy.



Color Outline

MENU button →  retouch menu

Create an outline copy of a photograph to use as a base for painting. The effect can be previewed in the edit display. Press  to save the retouched copy.





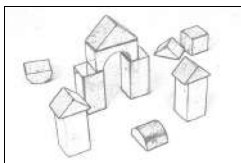

Before



After

Color Sketch

MENU button →  retouch menu

Create a copy of a photograph that resembles a sketch made with colored pencils. Press  or  to highlight **Vividness** or **Outlines** and press  or  to change. Vividness can be increased to make colors more saturated, or decreased for a washed-out, monochromatic effect, while outlines can be made thicker or thinner. Thicker outlines makes colors more saturated. The results can be previewed in the edit display. Press  to save the retouched copy.



Perspective Control

MENU button →  retouch menu

Create copies that reduce the effects of perspective taken from the base of a tall object. Use the multi selector to adjust perspective (note that greater amounts of perspective control result in more of the edges being cropped out). The results can be previewed in the edit display. Press  to save the retouched copy.



Before



















After

Miniature Effect

MENU button →  retouch menu

Create a copy that appears to be a photo of a diorama. Works best with photos taken from a high vantage point. The area that will be in focus in the copy is indicated by a yellow frame.

To	Press	Description
Choose orientation		Press  to choose orientation of area that is in focus.
Choose position		If area of effect is in wide orientation, press  or  to position frame showing area of copy that will be in focus.
		If area of effect is in tall orientation, press  or  to position frame showing area of copy that will be in focus.
Choose size		If area of effect is in wide orientation, press  or  to choose height.
		If area of effect is in tall orientation, press  or  to choose width.
Preview copy		Preview copy.
Create copy		Create copy.



Area in focus

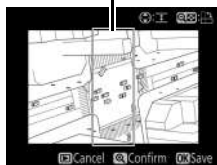

Selective Color

MENU button →  retouch menu



Create a copy in which only selected hues appear in color.

1 Select Selective color.

Highlight **Selective color** in the retouch menu and press  to display a picture selection dialog.





2 Select a photograph.

Use the multi selector to highlight a photograph (to view the highlighted photograph full frame, press and hold the  button; to view images in other locations as described on page 237, press ). Press  to select the highlighted photograph and proceed to the next step.



3 Select a color.

Use the multi selector to position the cursor over an object and press center of multi selector to select the color of the object as one that will remain in the final copy (the camera may have difficulty detecting unsaturated colors; choose a saturated color). To zoom in on the picture for precise color selection, press . Press  to zoom out.

Selected color



4 Highlight the color range.

Rotate the main command dial to highlight the color range for the selected color.



Color range



5 Choose the color range.

Press \odot or \ominus to increase or decrease the range of similar hues that will be included in the final photograph. Choose from values between 1 and 7; note that higher values may include hues from other colors. The effect can be previewed in the edit display.



6 Select additional colors.

To select additional colors, rotate the main command dial to highlight another of the three color boxes at the top of the display and repeat Steps 3–5 to select another color. Repeat for a third color if desired. To deselect the highlighted color, press ⏏ (FORMAT); to remove all colors, press and hold ⏏ (FORMAT). A confirmation dialog will be displayed; select **Yes**.



- 7 Save the edited copy.**
Press **OK** to save the retouched copy.



Side-by-Side Comparison

Compare retouched copies to the original photographs. This option is only available if the **i** button is pressed to display the retouch menu when a copy or original is played back full frame.

- 1 Select a picture.**
Select a retouched copy (shown by a  icon) or a photograph that has been retouched in full-frame playback and press **i**.

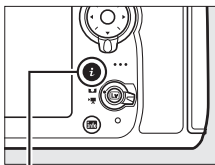







i button

- 2 Select Side-by-side comparison.**
Highlight **Side-by-side comparison** and press **OK**.



3 Compare the copy with the original.

The source image is displayed on the left, the retouched copy on the right, with the options used to create the copy listed at the top of the display. Press  or  to switch between the source image and the retouched copy. To view the highlighted picture full frame, press and hold the  button. If the copy was created from two source images using **Image overlay**,

press  or  to view the other source image. To exit to playback, press the  button, or press  to exit to playback with the highlighted image selected.



Options used to create copy



*Source
image*

*Retouched
copy*

Side-by-Side Comparison

The source image will not be displayed if the copy was created from a photograph that was protected ( 250) or has since been deleted or hidden ( 281).

My Menu / **Recent Settings**

To display My Menu, press **MENU** and select the  (My Menu) tab.





The **MY MENU** option can be used to create and edit a customized list of options from the playback, shooting, Custom Settings, setup, and retouch menus for quick access (up to 20 items). If desired, recent settings can be displayed in place of My Menu (📖 418).

Options can be added, deleted, and reordered as described below.

■ **Adding Options to My Menu**

1 Select **Add items**.

In My Menu () , highlight **Add items** and press .



2 Select a menu.

Highlight the name of the menu containing the option you wish to add and press .



3 Select an item.

Highlight the desired menu item and press **OK**.



4 Position the new item.

Press **▲** or **▼** to move the new item up or down in My Menu. Press **OK** to add the new item.



5 Add more items.

The items currently displayed in My Menu are indicated by a check mark. Items indicated by a **□** icon can not be selected. Repeat steps 1–4 to select additional items.



■ Deleting Options from My Menu

1 Select Remove items.

In My Menu (M), highlight **Remove items** and press **▶**.

2 Select items.

Highlight items and press **▶** to select or deselect. Selected items are indicated by a check mark.

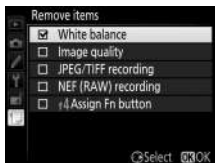

3 Delete the selected items.

Press **OK**. A confirmation dialog will be displayed; press **OK** again to delete the selected items.

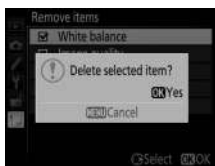

✎ Deleting Items in My Menu

To delete the item currently highlighted in My Menu, press the **⏏** (FORMAT) button. A confirmation dialog will be displayed; press **⏏** (FORMAT) again to remove the selected item from My Menu.

■ Reordering Options in My Menu

1 Select Rank items.

In My Menu (☰), highlight **Rank items** and press **↵**.

2 Select an item.

Highlight the item you wish to move and press **OK**.



3 Position the item.

Press **↑** or **↓** to move the item up or down in My Menu and press **OK**. Repeat Steps 2–3 to reposition additional items.



4 Exit to My Menu.

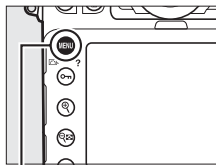

Press the **MENU** button to return to My Menu.



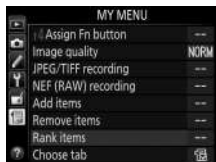

MENU button



Recent Settings



To display the twenty most recently used settings, select  **RECENT SETTINGS** for  **MY MENU** > **Choose tab**.

1 Select Choose tab.

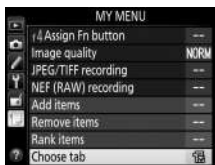

In My Menu () , highlight **Choose** **tab** and press .





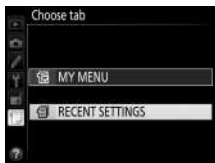

2 Select **RECENT SETTINGS**.

Highlight  **RECENT SETTINGS** and press . The name of the menu will change from “MY MENU” to “RECENT SETTINGS.”



Menu items will be added to the top of the recent settings menu as they are used. To view My Menu again, select  **MY MENU** for  **RECENT SETTINGS** > **Choose tab**.

Removing Items from the Recent Settings Menu



To remove an item from the recent settings menu, highlight it and press the  () button. A confirmation dialog will be displayed; press  () again to delete the selected item.

Technical Notes

Read this chapter for information on compatible accessories, cleaning and storing the camera, and what to do if an error message is displayed or you encounter problems using the camera.

Compatible Lenses

Camera setting Lens/accessory		Focus mode		Exposure mode		Metering system				
		AF	M (with electronic rangefinder) ¹	P S	A M	☒ ²		☒ ³	☒ ⁴	☒ ⁵
						3D	Color			
CPU lenses ⁶	Type G, E, or D AF NIKKOR ⁷ AF-S, AF-I NIKKOR	✓	✓	✓	✓	✓	—	✓ ⁸	✓	
	PC-E NIKKOR series ⁹	—	✓ ¹⁰	✓ ¹⁰	✓ ¹⁰	✓ ¹⁰	—	✓ ^{8,10}	✓	
	PC Micro 85mm f/2.8D ¹¹	—	✓ ¹⁰	—	✓ ¹²	✓	—	✓ ^{8,10}	✓	
	AF-S / AF-I Teleconverter ¹³	✓	✓	✓	✓	✓	—	✓ ⁸	✓	
	Other AF NIKKOR (except lenses for F3AF)	✓ ¹⁴	✓ ¹⁴	✓	✓	—	✓	✓ ⁸	—	
	AI-P NIKKOR	—	✓ ¹⁵	✓	✓	—	✓	✓ ⁸	—	

Camera setting Lens/accessory		Focus mode		Exposure mode		Metering system			
		AF	M (with electronic rangefinder) ¹	P S	A M	 ²		 ³	 ⁴
						3D	Color		
Non-CPU lenses ¹⁶	AI-, AI-modified NIKKOR or Nikon Series E lenses ¹⁷	—	✓ ¹⁵	—	✓ ¹⁸	—	✓ ¹⁹	✓ ²⁰	—
	Medical-NIKKOR 120mm f/4	—	✓	—	✓ ²¹	—	—	—	—
	Reflex-NIKKOR	—	—	—	✓ ¹⁸	—	—	✓ ²⁰	—
	PC-NIKKOR	—	✓ ¹⁰	—	✓ ²²	—	—	✓	—
	AI-type Teleconverter ²³	—	✓ ²⁴	—	✓ ¹⁸	—	✓ ¹⁹	✓ ²⁰	—
	PB-6 Bellows Focusing Attachment ²⁵	—	✓ ²⁴	—	✓ ²⁶	—	—	✓	—
	Auto extension rings (PK-series 11A, 12, or 13; PN-11)	—	✓ ²⁴	—	✓ ¹⁸	—	—	✓	—

- Manual focus available with all lenses.
- Matrix.
- Center-weighted.
- Spot.
- Highlight-weighted.
- IX-NIKKOR lenses can not be used.
- Vibration Reduction (VR) supported with VR lenses.
- Spot metering meters selected focus point ( 114).
- The tilt knob for the PC-E NIKKOR 24mm f/3.5D ED may contact the camera body when the lens is revolved. This can be prevented by installing a smaller tilt knob; contact a Nikon-authorized service representative for more information.
- Can not be used with shifting or tilting.
- The camera's exposure metering and flash control systems do not work properly when shifting and/or tilting the lens, or when an aperture other than the maximum aperture is used.

- 12 Manual exposure mode only.
- 13 Can be used with AF-S and AF-I lenses only (□ 423). For information on the focus points available for autofocus and electronic rangefinding, see page 423.
- 14 When focusing at minimum focus distance with AF 80–200mm f/2.8, AF 35–70mm f/2.8, AF 28–85mm f/3.5–4.5 <New>, or AF 28–85mm f/3.5–4.5 lens at maximum zoom, in-focus indicator may be displayed when image on matte screen in viewfinder is not in focus. Adjust focus manually until image in viewfinder is in focus.
- 15 With maximum aperture of f/5.6 or faster.
- 16 Some lenses can not be used (see page 424).
- 17 Range of rotation for AI 80–200mm f/2.8 ED tripod mount is limited by camera body. Filters can not be exchanged while AI 200–400mm f/4 ED is mounted on camera.
- 18 If maximum aperture is specified using **Non-CPU lens data** (□ 229), aperture value will be displayed in viewfinder and control panel.
- 19 Can be used only if lens focal length and maximum aperture are specified using **Non-CPU lens data** (□ 229). Use spot or center-weighted metering if desired results are not achieved.
- 20 For improved precision, specify lens focal length and maximum aperture using **Non-CPU lens data** (□ 229).
- 21 Can be used in manual exposure modes at shutter speeds slower than flash sync speed by one step or more.
- 22 Exposure determined by presetting lens aperture. In aperture-priority auto exposure mode, preset aperture using lens aperture ring before performing AE lock and shifting lens. In manual exposure mode, preset aperture using lens aperture ring and determine exposure before shifting lens.
- 23 Exposure compensation required when used with AI 28–85mm f/3.5–4.5, AI 35–105mm f/3.5–4.5, AI 35–135mm f/3.5–4.5, or AF-S 80–200mm f/2.8D.
- 24 With maximum effective aperture of f/5.6 or faster.
- 25 Requires PK-12 or PK-13 auto extension ring. PB-6D may be required depending on camera orientation.
- 26 Use preset aperture. In aperture-priority auto exposure mode, set aperture using focusing attachment before determining exposure and taking photograph.

- PF-4 Reprocopy Outfit requires PA-4 Camera Holder.
- Noise in the form of lines may appear during autofocus at high ISO sensitivities. Use manual focus or focus lock. Lines may also appear at high ISO sensitivities when aperture is adjusted during movie recording or live view photography.

☑ Recognizing CPU and Type G, E, and D Lenses

CPU lenses (particularly types G, E, and D) are recommended, but note that IX-NIKKOR lenses can not be used. CPU lenses can be identified by the presence of CPU contacts, type G, E, and D lenses by a letter on the lens barrel. Type G and E lenses are not equipped with a lens aperture ring.

CPU contacts

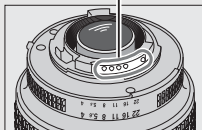

CPU lens

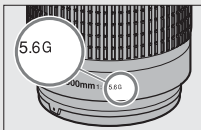

Type G/E lens



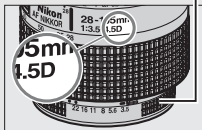



Aperture ring



Type D lens

The AF-S/AF-I Teleconverter

The table below shows the focus points available for autofocus and electronic rangefinding when an AF-S/AF-I teleconverter is attached. Note that the camera may be unable to focus on dark or low-contrast subjects if the combined aperture is slower than $f/5.6$. Autofocus is not available when teleconverters are used with the AF-S VR Micro-Nikkor 105mm $f/2.8G$ IF-ED.

Accessory	Maximum aperture of lens	Focus points
TC-14E, TC-14E II, TC-14E III	$f/4$ or faster	
	$f/5.6$	
TC-17E II	$f/2.8$ or faster	
	$f/4$	
	$f/5.6$	— ²
TC-20E, TC-20E II, TC-20E III	$f/2.8$ or faster	
	$f/4$	
	$f/5.6$	— ²
TC-800-1.25E ED	$f/5.6$	

- 1 Single point AF is used when 3D-tracking or auto-area AF is selected for AF-area mode (□ 90).
- 2 Autofocus not available.
- 3 Focus data for focus points other than the center focus point are obtained from line sensors.

Lens f-number

The f-number given in lens names is the maximum aperture of the lens.

Compatible Non-CPU Lenses

Non-CPU lens data (📖 229) can be used to enable many of the features available with CPU lenses, including color matrix metering; if no data are provided, center-weighted metering will be used in place of color matrix metering, while if the maximum aperture is not provided, the camera aperture display will show the number of stops from maximum aperture and the actual aperture value must be read off the lens aperture ring.

Incompatible Accessories and Non-CPU Lenses

The following can NOT be used with the D810:

- TC-16A AF teleconverter
- Non-AI lenses
- Lenses that require the AU-1 focusing unit (400mm f/4.5, 600mm f/5.6, 800mm f/8, 1200mm f/11)
- Fisheye (6mm f/5.6, 7.5mm f/5.6, 8mm f/8, OP 10mm f/5.6)
- 2.1cm f/4
- Extension Ring K2
- 180–600mm f/8 ED (serial numbers 174041–174180)
- 360–1200mm f/11 ED (serial numbers 174031–174127)
- 200–600mm f/9.5 (serial numbers 280001–300490)
- AF lenses for the F3AF (AF 80mm f/2.8, AF 200mm f/3.5 ED, AF Teleconverter TC-16)
- PC 28mm f/4 (serial number 180900 or earlier)
- PC 35mm f/2.8 (serial numbers 851001–906200)
- PC 35mm f/3.5 (old type)
- Reflex 1000mm f/6.3 (old type)
- Reflex 1000mm f/11 (serial numbers 142361–143000)
- Reflex 2000mm f/11 (serial numbers 200111–200310)

✓ AF-Assist Illumination

Some lenses may block the illuminator at certain focus distances. Remove lens hoods when using the illuminator. More information on lenses that can be used with the AF-assist illuminator may be found on page 494.

☑ The Built-in Flash

The built-in flash can be used with CPU lenses with focal lengths of 24 mm (16 mm in DX format) to 300 mm, although in some cases the flash may be unable to entirely light the subject at some ranges or focal lengths due to shadows cast by the lens, while lenses that block the subject's view of the red-eye reduction lamp may interfere with red-eye reduction. Remove lens hoods to prevent shadows. The flash has a minimum range of 0.6 m (2 ft) and can not be used in the macro range of macro zoom lenses. The following illustrations show the effect of vignetting caused by shadows cast by the lens when the flash is used.

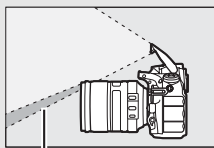

Shadow



Vignetting

More information on lenses that can be used with the built-in flash may be found on page 494.

Calculating Angle of View

The D810 can be used with Nikon lenses for 35 mm (135) format cameras. If **Auto DX crop** is on ( 75) and a 35 mm format lens is attached, the angle of view will be the same as a frame of 35 mm film (35.9 × 24.0 mm); if a DX lens is attached, the angle of view will automatically be adjusted to 23.4 × 15.6 mm (DX format).

To choose an angle of view different from that of the current lens, turn **Auto DX crop** off and select from **FX (36×24)**, **1.2× (30×20)**, **DX (24×16)**, and **5 : 4 (30×24)**. If a 35 mm format lens is attached, the angle of view could be reduced by 1.5× by selecting **DX (24×16)** or by 1.2× by selecting **1.2× (30×20)**, to expose a smaller area, or the aspect ratio could be changed by selecting **5 : 4 (30×24)**.

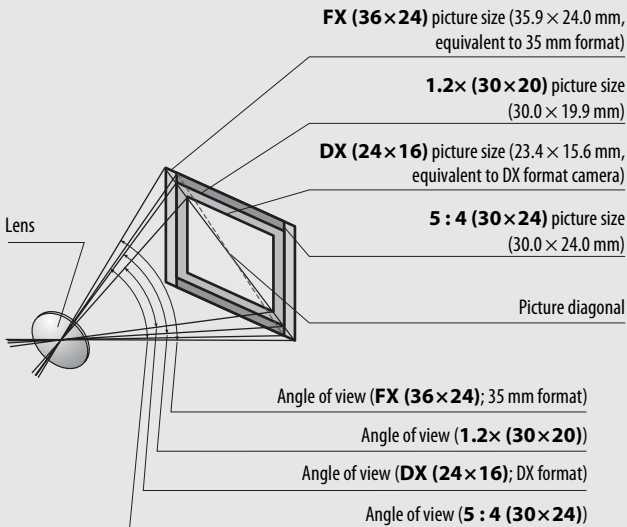

Calculating Angle of View (Continued)

The **DX (24×16)** angle of view is about 1.5 times smaller than the 35 mm format angle of view, while the **1.2× (30×20)** angle of view is about 1.2 times smaller and the **5 : 4 (30×24)** angle of view is about 1.1 times smaller. To calculate the focal length of lenses in 35 mm format when **DX (24×16)** is selected, multiply the focal length of the lens by about 1.5, by about 1.2 when **1.2× (30×20)** is selected, or by about 1.1 when **5 : 4 (30×24)** is selected (for example, the effective focal length of a 50 mm lens in 35 mm format would be 75 mm when **DX (24×16)** is selected, 60 mm when **1.2× (30×20)** is selected, or 55 mm when **5 : 4 (30×24)** is selected).

Optional Flash Units (Speedlights)

The camera supports the Nikon Creative Lighting System (CLS) and can be used with CLS-compatible flash units. The built-in flash will not fire when an optional flash unit is attached.

The Nikon Creative Lighting System (CLS)

Nikon's advanced Creative Lighting System (CLS) offers improved communication between the camera and compatible flash units for improved flash photography.

■ *CLS-Compatible Flash Units*

The camera can be used with the following CLS-compatible flash units:

- **The SB-910, SB-900, SB-800, SB-700, SB-600, SB-400, SB-300, and SB-R200:**

Flash unit		SB-910, SB-900 ¹	SB-800	SB-700 ¹	SB-600	SB-400 ²	SB-300 ²	SB-R200 ³
Feature								
Guide No. ⁴	ISO 100	34/111	38/125	28/92	30/98	21/69	18/59	10/33
	ISO 200	48/157	53/174	39/128	42/138	30/98	25/82	14/46

- 1 If a color filter is attached to the SB-910, SB-900, or SB-700 when **AUTO** or  (flash) is selected for white balance, the camera will automatically detect the filter and adjust white balance appropriately.
- 2 Wireless flash control is not available.
- 3 Controlled remotely with built-in flash in commander mode or using optional SB-910, SB-900, SB-800, or SB-700 flash unit or SU-800 wireless Speedlight commander.
- 4 m/ft, 20 °C (68 °F), SB-910, SB-900, SB-800, SB-700, and SB-600 at 35 mm zoom head position; SB-910, SB-900, and SB-700 with standard illumination.

- **SU-800 Wireless Speedlight Commander:** When mounted on a CLS-compatible camera, the SU-800 can be used as a commander for remote SB-910, SB-900, SB-800, SB-700, SB-600, or SB-R200 flash units in up to three groups. The SU-800 itself is not equipped with a flash.

Guide Number

To calculate the range of the flash at full power, divide the Guide Number by the aperture. If, for example, the flash unit has a Guide Number of 34 m or 111 ft (ISO 100, 20 °C/68 °F); its range at an aperture of f/5.6 is $34 \div 5.6$ or about 6.1 meters (or in feet, $111 \div 5.6 =$ approximately 19 ft 10 in.). For each twofold increase in ISO sensitivity, multiply the Guide Number by the square root of two (approximately 1.4).

The Sync Terminal

A sync cable can be connected to the sync terminal as required. Do not connect another flash unit via a sync cable when performing rear-curtain sync flash photography with a flash unit mounted on the camera accessory shoe.

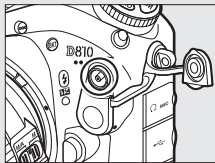

The following features are available with CLS-compatible flash units:

		SB-910, SB-900, SB-800	SB-700	SB-600	SU-800	SB-R200	SB-400	SB-300		
Single flash	i-TTL	i-TTL balanced fill-flash for digital SLR ¹	✓	✓	✓	—	—	✓	✓	
		Standard i-TTL flash for digital SLR	✓ ²	✓	✓ ²	—	—	✓	✓	
	AA	Auto aperture	✓ ³	—	—	—	—	—	—	
	A	Non-TTL auto	✓ ³	—	—	—	—	—	—	
	GN	Distance-priority manual	✓	✓	—	—	—	—	—	
	M	Manual	✓	✓	✓	—	—	✓ ⁴	✓ ⁴	
	RPT	Repeating flash	✓	—	—	—	—	—	—	
Advanced Wireless Lighting	Master	Remote flash control	✓	✓	—	✓	—	—	—	
		i-TTL i-TTL	✓	✓	—	—	—	—	—	
		[A:B]	Quick wireless flash control	—	✓	—	✓ ⁵	—	—	—
		AA	Auto aperture	✓ ⁶	—	—	—	—	—	—
		A	Non-TTL auto	✓	—	—	—	—	—	—
		M	Manual	✓	✓	—	—	—	—	—
		RPT	Repeating flash	✓	—	—	—	—	—	—
	Remote	i-TTL i-TTL	✓	✓	✓	—	✓	—	—	
		[A:B]	Quick wireless flash control	✓	✓	✓	—	✓	—	—
		AA	Auto aperture	✓ ⁶	—	—	—	—	—	—
		A	Non-TTL auto	✓	—	—	—	—	—	—
		M	Manual	✓	✓	✓	—	✓	—	—
		RPT	Repeating flash	✓	✓	✓	—	—	—	—

	SB-910, SB-900, SB-800	SB-700	SB-600	SU-800	SB-R200	SB-400	SB-300
Color Information Communication	✓	✓	✓	—	—	✓	✓
Auto FP High-Speed Sync ⁷	✓	✓	✓	✓	✓	—	—
FV lock ⁸	✓	✓	✓	✓	✓	✓	✓
AF-assist for multi-area AF	✓	✓	✓	✓ ⁹	—	—	—
Red-eye reduction	✓	✓	✓	—	—	✓	—
Camera modeling illumination	✓	✓	✓	✓	✓	—	—
Camera flash mode selection	—	—	—	—	—	✓	✓
Camera flash unit firmware update	✓ ¹⁰	✓	—	—	—	—	✓

1 Not available with spot metering.

2 Can also be selected with flash unit.

3 AA/A mode selection performed on flash unit using custom settings. Unless lens data have been provided using the **Non-CPU lens data** option in the setup menu, “A” will be selected when a non-CPU lens is used.

4 Can only be selected with camera.

5 Available only during close-up photography.

6 Unless lens data have been provided using the **Non-CPU lens data** option in the setup menu, non-TTL auto (A) is used with non-CPU lenses, regardless of mode selected with flash unit.

7 Available only in i-TTL, AA, A, GN, and M flash-control modes.

8 Available only in i-TTL, AA, and A flash-control modes.

9 Available only in commander mode.

10 Firmware updates for the SB-910 and SB-900 can be performed from the camera.

■ Other Flash Units

The following flash units can be used in non-TTL auto and manual modes.

Flash mode \ Flash unit	SB-80DX, SB-28DX, SB-28, SB-26, SB-25, SB-24	SB-50DX	SB-30, SB-27 ¹ , SB-22S, SB-22, SB-20, SB-16B, SB-15	SB-23, SB-29 ² , SB-21B ² , SB-29S ²
A Non-TTL auto	✓	—	✓	—
M Manual	✓	✓	✓	✓
 Repeating flash	✓	—	—	—
REAR Rear-curtain sync ³	✓	✓	✓	✓

- 1 Flash mode is automatically set to TTL and shutter-release is disabled. Set flash unit to **A** (non-TTL auto flash).
- 2 Autofocus is available with AF-S VR Micro-Nikkor 105mm f/2.8G IF-ED and AF-S Micro NIKKOR 60mm f/2.8G ED lenses only.
- 3 Available when camera is used to select flash mode.

✔ Notes on Optional Flash Units

Refer to the flash unit manual for detailed instructions. If the unit supports CLS, refer to the section on CLS-compatible digital SLR cameras. The D810 is not included in the “digital SLR” category in the SB-80DX, SB-28DX, and SB-50DX manuals.

i-TTL flash control can be used at ISO sensitivities between 64 and 12800. At high ISO sensitivities, noise (lines) may appear in photos taken with some optional flash units; if this occurs, choose a lower value. At values under 64 or over 12800, the desired results may not be achieved at some ranges or aperture settings. If the flash-ready indicator flashes for about three seconds after a photograph is taken in i-TTL or non-TTL auto mode, the flash has fired at full power and the photograph may be underexposed (CLS-compatible flash units only; for information on the exposure and flash charge indicators on other units, see the manual provided with the flash).

When an SC-series 17, 28, or 29 sync cable is used for off-camera flash photography, correct exposure may not be achieved in i-TTL mode. We recommend that you select standard i-TTL flash control. Take a test shot and view the results in the monitor.

In i-TTL, use the flash panel or bounce adapter provided with the flash unit. Do not use other panels such as diffusion panels, as this may produce incorrect exposure.

The SB-910, SB-900, SB-800, SB-700, SB-600, and SB-400 provide red-eye reduction, while the SB-910, SB-900, SB-800, SB-700, SB-600, and SU-800 provide AF-assist illumination with the following restrictions:

- **SB-910 and SB-900:** AF-assist illumination is available when 17–135 mm AF lenses are used with the focus points shown at right.



- **SB-800, SB-600, and SU-800:** AF-assist illumination is available when 24–105 mm AF lenses are used with the focus points shown at right.

24–34 mm	
35–49 mm	
50–105 mm	

- **SB-700:** AF-assist illumination is available when 24–135 mm AF lenses are used with the focus points shown at right.



Depending on the lens used and scene recorded, the in-focus indicator (●) may be displayed when the subject is not in focus, or the camera may be unable to focus and the shutter release will be disabled.













In exposure mode *P*, the maximum aperture (minimum f-number) is limited according to ISO sensitivity, as shown below:

Maximum aperture at ISO equivalent of:								
64	100	200	400	800	1600	3200	6400	12800
3.3	4	4.8	5.6	6.7	8	9.5	11	13

If the maximum aperture of the lens is smaller than given above, the maximum value for aperture will be the maximum aperture of the lens.

Flash Control Mode

The information display shows the flash control mode for optional flash units attached to the camera accessory shoe as follows:

	Flash sync	Auto FP (📖 330)
i-TTL		
Auto aperture (AA)		
Non-TTL auto flash (A)		
Distance-priority manual (GN)		
Manual		
Repeating flash		—
Advanced wireless lighting		

Use Only Nikon Flash Accessories

Use only Nikon flash units. Negative voltages or voltages over 250 V applied to the accessory shoe could not only prevent normal operation, but damage the sync circuitry of the camera or flash. Before using a Nikon flash unit not listed in this section, contact a Nikon-authorized service representative for more information.

Other Accessories

At the time of writing, the following accessories were available for the D810.

Power sources	<ul style="list-style-type: none">• Rechargeable Li-ion Battery EN-EL15 (☐ 13, 14): Additional EN-EL15 batteries are available from local retailers and Nikon-authorized service representatives.• Battery Charger MH-25a (☐ 13): The MH-25a can be used to recharge EN-EL15 batteries. MH-25 battery chargers can also be used.• Multi-Power Battery Pack MB-D12: The MB-D12 is equipped with a shutter-release button, AF-ON button, multi-selector, and main- and sub-command dials for improved operation when taking photographs in portrait (tall) orientation. When attaching the MB-D12, remove the camera MB-D12 contact cover. A BL-5 battery-chamber cover and an MH-26a or MH-26 battery charger are required when using EN-EL18a and EN-EL18 batteries.• Power Connector EP-5B, AC Adapter EH-5b: These accessories can be used to power the camera for extended periods (EH-5a and EH-5 AC adapters can also be used). The EP-5B is required to connect the camera to the EH-5b; see page 442 for details. Note that when the camera is used with an MB-D12, the EP-5B must be inserted into the MB-D12, not the camera. Do not attempt to use the camera with power connectors inserted into both the camera and MB-D12.
Body caps	Body Cap BF-1B/Body Cap BF-1A : The body cap keeps the mirror, viewfinder screen, and image sensor free of dust when a lens is not in place.
Accessory shoe covers	Accessory Shoe Cover BS-1 : A cover protecting the accessory shoe. The accessory shoe is used for optional flash units.

LAN adapters
(261)

- **Communication Unit UT-1:** Use a USB cable to connect the UT-1 to the camera and an Ethernet cable to connect the UT-1 to an Ethernet network. Once connected, you can upload photos and movies to a computer or ftp server, control the camera remotely using optional Camera Control Pro 2 software, or browse pictures or control the camera remotely from an iPhone or web computer browser.
- **USB Cable Gaskets and Connector Covers:** Use a UF-4 connector cover for USB cables and UF3-RU14 USB cable gasket to help prevent accidental disconnections. Before connecting the cable, attach the UF-4 at the camera end and the UF3-RU14 at the end that connects to the communication unit.

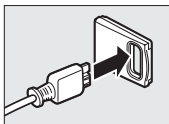

UF-4 (attaches to connector for camera)

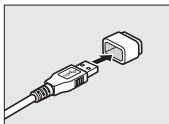
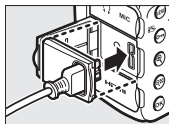

UF3-RU14 (attaches to connector for UT-1)

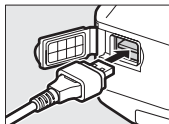

- **Wireless Transmitter WT-5:** Attach the WT-5 to the UT-1 to access wireless networks.

Note: Use of LAN adapters requires an Ethernet or wireless network and some basic network knowledge. Be sure to upgrade any related software to the latest version.

**Viewfinder
eyepiece
accessories**

- **Rubber Eyecup DK-19:** The DK-19 makes the image in the viewfinder easier to see, preventing eye fatigue.
- **Diopter-Adjustment Viewfinder Lens DK-17C:** To accommodate individual differences in vision, viewfinder lenses are available with diopters of -3 , -2 , 0 , $+1$, and $+2$ m^{-1} . Use diopter adjustment lenses only if the desired focus can not be achieved with the built-in diopter adjustment control (-3 to $+1$ m^{-1}). Test diopter adjustment lenses before purchase to ensure that the desired focus can be achieved.
- **Magnifying Eyepiece DK-17M:** The DK-17M magnifies the view through the viewfinder by approximately $1.2\times$ for greater precision when framing.
- **Eyepiece Magnifier DG-2:** The DG-2 magnifies the scene at the center of the viewfinder for more accurate focus. DK-18 eyepiece adapter (available separately) required.
- **Eyepiece Adapter DK-18:** The DK-18 is used when attaching the DG-2 magnifier or DR-3 right-angle viewing attachment to the D810.
- **Antifog Finder Eyepiece DK-14/Antifog Finder Eyepiece DK-17A:** These viewfinder eyepieces prevent fogging in humid or cold conditions.
- **Right-Angle Viewing Attachment DR-5/Right-Angle Viewing Attachment DR-4:** The DR-5 and DR-4 attach to the viewfinder eyepiece at a right angle, allowing the image in the viewfinder to be viewed from above when the camera is in the horizontal shooting position. The DR-5 supports diopter adjustment and can also magnify the view through the viewfinder by $2\times$ for greater precision when framing (note that the edges of the frame will not be visible when the view is magnified).

Remote terminal accessories

The D810 is equipped with a ten-pin remote terminal (□ 3) for remote control and automatic photography. The terminal is provided with a cap, which protects the contacts when the terminal is not in use. The following accessories can be used (all lengths are approximate):

- **Remote Cord MC-22/MC-22A:** Remote shutter release with blue, yellow, and black terminals for connection to a remote shutter-triggering device, allowing control via sound or electronic signals (length 1 m/3 ft 3 in.).
- **Remote Cord MC-30/MC-30A:** Remote shutter release; can be used to reduce camera shake (length 80 cm/2 ft 7 in.).
- **Remote Cord MC-36/MC-36A:** Remote shutter release; can be used for interval timer photography or to reduce camera shake or keep the shutter open during a time exposure (length 85 cm/2 ft 9 in.).
- **Extension Cord MC-21/MC-21A:** Can be connected to ML-3 or MC-series 20, 22, 22A, 23, 23A, 25, 25A, 30, 30A, 36, or 36A. Only one MC-21 or MC-21A can be used at a time (length 3 m/9 ft 10 in.).
- **Connecting Cord MC-23/MC-23A:** Connects two cameras with ten-pin remote terminals for simultaneous operation (length 40 cm/1 ft 4 in.).
- **Adapter Cord MC-25/MC-25A:** Ten-pin to two-pin adapter cord for connection to devices with two-pin terminals, including the MW-2 radio control set, MT-2 intervalometer, and ML-2 modulite remote control set (length 20 cm/8 in.).
- **WR Adapter WR-A10:** An adapter used to connect WR-R10 wireless remote controllers (□ 441) to cameras with ten-pin remote terminals.
- **GPS Unit GP-1/GP-1A (□ 233):** Record latitude, longitude, altitude, and UTC time with pictures.

Remote terminal accessories	<ul style="list-style-type: none"> • GPS Adapter Cord MC-35 (☞ 233): This 35 cm (1 ft 2 in.) cable connects the camera to older GARMIN eTrex- and geko-series GPS units that conform to version 2.01 or 3.01 of the National Marine Electronics Association NMEA0183 data format. Only models that support PC interface cable connections are supported; the MC-35 can not be used to connect GPS units via USB. The units connect to the MC-35 using a cable with a D-sub 9-pin connector provided by the manufacturer of the GPS device; see the MC-35 instruction manual for details. Before turning the camera on, set the GPS device to NMEA mode (4800 baud); for more information, see the documentation provided with the GPS device. • Modulite Remote Control Set ML-3: Allows infrared remote control at ranges of up to 8 m (26 ft 3 in.).
HDMI cables (☞ 269)	<p>HDMI Cable HC-E1: An HDMI cable with a type C connector for connection to the camera and a type A connector for connection to HDMI devices.</p>
Filters	<ul style="list-style-type: none"> • Filters intended for special-effects photography may interfere with autofocus or the electronic rangefinder. • The D810 can not be used with linear polarizing filters. Use the C-PL or C-PLII circular polarizing filter instead. • Use NC filters to protect the lens. • To prevent ghosting, use of a filter is not recommended when the subject is framed against a bright light, or when a bright light source is in the frame. • Center-weighted metering is recommended with filters with exposure factors (filter factors) over 1 × (Y44, Y48, Y52, O56, R60, X0, X1, C-PL, ND2S, ND4, ND4S, ND8, ND8S, ND400, A2, A12, B2, B8, B12). See the filter manual for details.

Wireless remote controllers (☐ 357)	<ul style="list-style-type: none"> • Wireless Remote Controller WR-R10/WR-T10: When a WR-R10 wireless remote controller is attached to ten-pin remote terminal using a WR-A10 adapter, the camera can be controlled wirelessly using a WR-T10 wireless remote controller. • Wireless Remote Controller WR-1: The WR-1 can function as either a transmitter or a receiver and is used in combination either with another WR-1 or a WR-R10 or WR-T10 wireless remote controller. For example, a WR-1 can be connected to the ten-pin remote terminal for use as a receiver, allowing camera settings to be changed or the shutter to be released remotely by another WR-1 acting as a transmitter.
Software	<p>Camera Control Pro 2: Control the camera remotely from a computer to record movies and photographs and save photographs directly to the computer hard disk. When Camera Control Pro 2 is used to capture photographs directly to the computer, the PC connection indicator (P C) will appear in the control panel.</p> <p>Note: Use the latest versions of Nikon software; see the websites listed on page xxii for the latest information on supported operating systems. At default settings, Nikon Message Center 2 will periodically check for updates to Nikon software and firmware while you are logged in to an account on the computer and the computer is connected to the Internet. A message is automatically displayed when an update is found.</p>
Microphones	<p>Stereo Microphone ME-1: Connect the ME-1 to the camera microphone jack to record stereo sound and reduce the chance of picking up equipment noise (such as the sounds produced by the lens during autofocusing; ☐ 63).</p>

Availability may vary with country or region. See our website or brochures for the latest information.

Attaching a Power Connector and AC Adapter

Turn the camera off before attaching an optional power connector and AC adapter.

1 Ready the camera.

Open the battery-chamber (①) and power connector (②) covers.

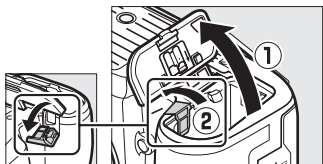

2 Insert the EP-5B power connector.

Be sure to insert the connector in the orientation shown, using the connector to keep the orange battery latch pressed to one side. The latch locks the connector in place when the connector is fully inserted.

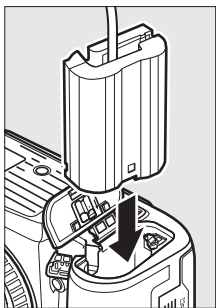

3 Close the battery-chamber cover.

Position the power connector cable so that it passes through the power connector slot and close the battery-chamber cover.

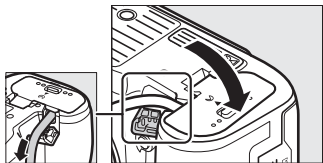

4 Connect the EH-5b AC adapter.

Connect the AC adapter power cable to the AC socket on AC adapter (3) and the power cable to the DC socket (4). A  icon is displayed in the monitor when the camera is powered by the AC adapter and power connector.

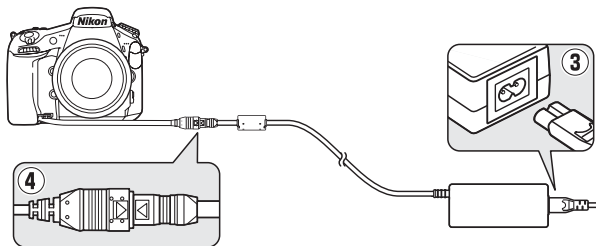

Caring for the Camera

Storage

When the camera will not be used for an extended period, remove the battery and store it in a cool, dry area with the terminal cover in place. To prevent mold or mildew, store the camera in a dry, well-ventilated area. Do not store your camera with naphtha or camphor moth balls or in locations that:

- are poorly ventilated or subject to humidities of over 60%
- are next to equipment that produces strong electromagnetic fields, such as televisions or radios
- are exposed to temperatures above 50 °C (122 °F) or below -10 °C (14 °F)

Cleaning

Camera body	Use a blower to remove dust and lint, then wipe gently with a soft, dry cloth. After using the camera at the beach or seaside, wipe off sand or salt with a cloth lightly dampened in distilled water and dry thoroughly. Important: <i>Dust or other foreign matter inside the camera may cause damage not covered under warranty.</i>
Lens, mirror, and viewfinder	These glass elements are easily damaged. Remove dust and lint with a blower. If using an aerosol blower, keep the can vertical to prevent the discharge of liquid. To remove fingerprints and other stains, apply a small amount of lens cleaner to a soft cloth and clean with care.
Monitor	Remove dust and lint with a blower. When removing fingerprints and other stains, wipe the surface lightly with a soft cloth or chamois leather. Do not apply pressure, as this could result in damage or malfunction.

Do not use alcohol, thinner, or other volatile chemicals.

Image Sensor Cleaning

If you suspect that dirt or dust on the image sensor is appearing in photographs, you can clean the sensor using the **Clean image sensor** option in the setup menu. The sensor can be cleaned at any time using the **Clean now** option, or cleaning can be performed automatically when the camera is turned on or off.

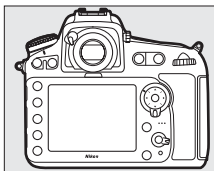

■ ■ “Clean Now”

Holding the camera base down, select **Clean image sensor** in the setup menu, then highlight **Clean now** and press **OK**. The camera will check the image sensor and then begin cleaning. Other operations can not be performed while cleaning is in progress. Do not remove or disconnect the power source until cleaning ends and the setup menu is displayed.



■ “Clean at Startup/Shutdown”

Choose from the following options:

Option	Description
 Clean at startup	The image sensor is automatically cleaned each time the camera is turned on.
 Clean at shutdown	The image sensor is automatically cleaned during shutdown each time the camera is turned off.
 Clean at startup & shutdown	The image sensor is cleaned automatically at startup and at shutdown.
Cleaning off	Automatic image sensor cleaning off.

1 Select **Clean at startup/shutdown**.

Display the **Clean image sensor** menu as described on page 445. Highlight **Clean at startup/shutdown** and press .



2 Select an option.

Highlight an option and press .

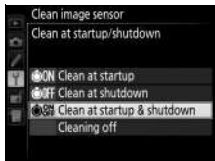

Image Sensor Cleaning

Using camera controls during startup interrupts image sensor cleaning. Image sensor cleaning may not be performed at startup if the flash is charging.

If dust can not be fully removed using the options in the **Clean image sensor** menu, clean the image sensor manually (📖 448) or consult a Nikon-authorized service representative.

If image sensor cleaning is performed several times in succession, image sensor cleaning may be temporarily disabled to protect the camera's internal circuitry. Cleaning can be performed again after a short wait.

Manual Cleaning

If foreign matter can not be removed from the image sensor using the **Clean image sensor** (📖 445) option in the setup menu, the sensor can be cleaned manually as described below. Note, however, that the sensor is extremely delicate and easily damaged. Nikon recommends that the sensor be cleaned only by Nikon-authorized service personnel.

1 Charge the battery or connect an AC adapter.

A reliable power source is required when inspecting or cleaning the image sensor. Turn the camera off and insert a fully-charged battery or connect an optional AC adapter and power connector. The **Lock mirror up for cleaning** option is only available in the setup menu at battery levels over .

2 Remove the lens.

Turn the camera off and remove the lens.

3 Select **Lock mirror up for cleaning**.

Highlight **Lock mirror up for cleaning** in the setup menu and press .



4 Press .

The message shown at right will be displayed in the monitor and a row of dashes will appear in the control panel and viewfinder. To restore normal operation without inspecting the image sensor, turn the camera off.

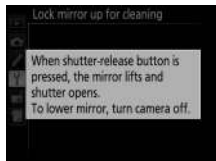

5 Raise the mirror.

Press the shutter-release button all the way down. The mirror will be raised and the shutter curtain will open, revealing the image sensor. The display in the viewfinder will turn off and the row of dashes in the control panel will flash.

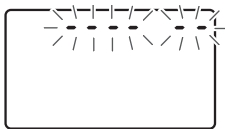

6 Examine the image sensor.

Holding the camera so that light falls on the image sensor, examine the sensor for dust or lint. If no foreign objects are present, proceed to Step 8.

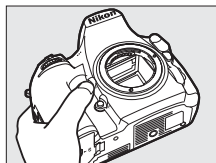

7 Clean the sensor.

Remove any dust and lint from the sensor with a blower. Do not use a blower-brush, as the bristles could damage the sensor. Dirt that can not be removed with a blower can only be removed by Nikon-authorized service personnel. Under no circumstances should you touch or wipe the sensor.

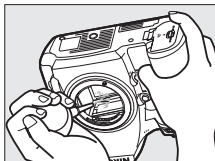

8 Turn the camera off.

The mirror will return to the down position and the shutter curtain will close. Replace the lens or body cap.

Use a Reliable Power Source

The shutter curtain is delicate and easily damaged. If the camera powers off while the mirror is raised, the curtain will close automatically. To prevent damage to the curtain, observe the following precautions:

- Do not turn the camera off or remove or disconnect the power source while the mirror is raised.
- If the battery runs low while the mirror is raised, a beep will sound and the self-timer lamp will flash to warn that the shutter curtain will close and the mirror will be lowered after about two minutes. End cleaning or inspection immediately.

✔ Foreign Matter on the Image Sensor

Nikon takes every possible precaution to prevent foreign matter from coming into contact with the image sensor during production and shipping. The D810, however, is designed to be used with interchangeable lenses, and foreign matter may enter the camera when lenses are removed or exchanged. Once inside the camera, this foreign matter may adhere to the image sensor, where it may appear in photographs taken under certain conditions. To protect the camera when no lens is in place, be sure to replace the body cap provided with the camera, being careful to first remove all dust and other foreign matter that may be adhering to the body cap. Avoid exchanging lenses in dusty environments.

Should foreign matter find its way onto the image sensor, clean the sensor as described above, or have the sensor cleaned by authorized Nikon service personnel. Photographs affected by the presence of foreign matter on the sensor can be retouched using the clean image options available in some imaging applications.

✔ Servicing the Camera and Accessories

The camera is a precision device and requires regular servicing. Nikon recommends that the camera be inspected by the original retailer or Nikon-authorized service representative once every one to two years, and that it be serviced once every three to five years (note that fees apply to these services). Frequent inspection and servicing are particularly recommended if the camera is used professionally. Any accessories regularly used with the camera, such as lenses or optional flash units, should be included when the camera is inspected or serviced.

Caring for the Camera and Battery: Cautions

Do not drop: The product may malfunction if subjected to strong shocks or vibration.

Keep dry: This product is not waterproof, and may malfunction if immersed in water or exposed to high levels of humidity. Rusting of the internal mechanism can cause irreparable damage.

Avoid sudden changes in temperature: Sudden changes in temperature, such as those that occur when entering or leaving a heated building on a cold day, can cause condensation inside the device. To prevent condensation, place the device in a carrying case or plastic bag before exposing it to sudden changes in temperature.

Keep away from strong magnetic fields: Do not use or store this device in the vicinity of equipment that generates strong electromagnetic radiation or magnetic fields. Strong static charges or the magnetic fields produced by equipment such as radio transmitters could interfere with the monitor, damage data stored on the memory card, or affect the product's internal circuitry.

Do not leave the lens pointed at the sun: Do not leave the lens pointed at the sun or other strong light source for an extended period. Intense light may cause the image sensor to deteriorate or produce a white blur effect in photographs.

Cleaning: When cleaning the camera body, use a blower to gently remove dust and lint, then wipe gently with a soft, dry cloth. After using the camera at the beach or seaside, wipe off any sand or salt using a cloth lightly dampened in pure water and then dry the camera thoroughly. In rare instances, static electricity may cause the LCD displays to light up or go dark. This does not indicate a malfunction, and the display will soon return to normal.

The lens and mirror are easily damaged. Dust and lint should be gently removed with a blower. When using an aerosol blower, keep the can vertical to prevent discharge of liquid. To remove fingerprints and other stains from the lens, apply a small amount of lens cleaner to a soft cloth and wipe the lens carefully.

See “Image Sensor Cleaning” (□ 445) for information on cleaning the image sensor.

Lens contacts: Keep the lens contacts clean.

Do not touch the shutter curtain: The shutter curtain is extremely thin and easily damaged. Under no circumstances should you exert pressure on the curtain, poke it with cleaning tools, or subject it to powerful air currents from a blower. These actions could scratch, deform, or tear the curtain.

The shutter curtain may appear to be unevenly colored, but this has no affect on pictures and does not indicate a malfunction.

Storage: To prevent mold or mildew, store the camera in a dry, well-ventilated area. If you are using an AC adapter, unplug the adapter to prevent fire. If the product will not be used for an extended period, remove the battery to prevent leakage and store the camera in a plastic bag containing a desiccant. Do not, however, store the camera case in a plastic bag, as this may cause the material to deteriorate. Note that desiccant gradually loses its capacity to absorb moisture and should be replaced at regular intervals.

To prevent mold or mildew, take the camera out of storage at least once a month. Turn the camera on and release the shutter a few times before putting it away.

Store the battery in a cool, dry place. Replace the terminal cover before putting the battery away.

Turn the product off before removing or disconnecting the power source: Do not unplug the product or remove the battery while the product is on or while images are being recorded or deleted. Forcibly cutting power in these circumstances could result in loss of data or in damage to product memory or internal circuitry. To prevent an accidental interruption of power, avoid carrying the product from one location to another while the AC adapter is connected.

Notes on the monitor: The monitor is constructed with extremely high precision; at least 99.99% of pixels are effective, with no more than 0.01% being missing or defective. Hence while these displays may contain pixels that are always lit (white, red, blue, or green) or always off (black), this is not a malfunction and has no effect on images recorded with the device.

Images in the monitor may be difficult to see in a bright light.

Do not apply pressure to the monitor, as this could cause damage or malfunction. Dust or lint on the monitor can be removed with a blower. Stains can be removed by wiping lightly with a soft cloth or chamois leather. Should the monitor break, care should be taken to avoid injury from broken glass and to prevent liquid crystal from the monitor touching the skin or entering the eyes and mouth.

Replace the monitor cover when transporting the camera or leaving it unattended.

The battery and charger: Batteries may leak or explode if improperly handled. *Read and follow the warnings and cautions on pages xiii–xvi of this manual.* Observe the following precautions when handling batteries:

- Use only batteries approved for use in this equipment.
- Do not expose the battery to flame or excessive heat.
- Keep the battery terminals clean.
- Turn the product off before replacing the battery.
- Remove the battery from the camera or charger when not in use and replace the terminal cover. These devices draw minute amounts of charge even when off and could draw the battery down to the point that it will no longer function. If the battery will not be used for some time, insert it in the camera and run it flat before removing it from the camera for storage. The battery should be stored in a cool location with an ambient temperature of 15 °C to 25 °C (59 °F to 77 °F; avoid hot or extremely cold locations). Repeat this process at least once every six months.

- Turning the camera on or off repeatedly when the battery is fully discharged will shorten battery life. Batteries that have been fully discharged must be charged before use.
- The internal temperature of the battery may rise while the battery is in use. Attempting to charge the battery while the internal temperature is elevated will impair battery performance, and the battery may not charge or charge only partially. Wait for the battery to cool before charging.
- Charge the battery indoors at ambient temperatures of 5 °C–35 °C (41 °F–95 °F). Do not use the battery at ambient temperatures below 0 °C (32 °F) or above 40 °C (104 °F); failure to observe this precaution could damage the battery or impair its performance. Capacity may be reduced and charging times increase at battery temperatures from 0 °C (32 °F) to 15 °C (59 °F) and from 45 °C (113 °F) to 60 °C (140 °F). The battery will not charge if its temperature is below 0 °C (32 °F) or above 60 °C (140 °F).
- If the **CHARGE** lamp flashes quickly (about eight times a second) during charging, confirm that the temperature is in the correct range and then unplug the charger and remove and reinsert the battery. If the problem persists, cease use immediately and take battery and charger to your retailer or a Nikon-authorized service representative.
- Do not move the charger or touch the battery during charging. Failure to observe this precaution could in very rare instances result in the charger showing that charging is complete when the battery is only partially charged. Remove and reinsert the battery to begin charging again. Battery capacity may temporarily drop if the battery is charged at low temperatures or used at a temperature below the temperature at which it was charged. If the battery is charged at a temperature below 5 °C (41 °F), the battery life indicator in the **Battery info** (☰ 374) display may show a temporary decrease.

- Continuing to charge the battery after it is fully charged can impair battery performance.
- A marked drop in the time a fully charged battery retains its charge when used at room temperature indicates that it requires replacement. Purchase a new EN-EL15 battery.
- The supplied power cable and AC wall adapter are for use with the MH-25a only. Use the charger with compatible batteries only. Unplug when not in use.
- Charge the battery before use. When taking photographs on important occasions, ready a spare battery and keep it fully charged. Depending on your location, it may be difficult to purchase replacement batteries on short notice. Note that on cold days, the capacity of batteries tends to decrease. Be sure the battery is fully charged before taking photographs outside in cold weather. Keep a spare battery in a warm place and exchange the two as necessary. Once warmed, a cold battery may recover some of its charge.
- Used batteries are a valuable resource; recycle in accord with local regulations.

Exposure Program

The exposure program for programmed auto (□ 118) is shown in the following graph:

— ISO 100; lens with maximum aperture of f/1.4 and minimum aperture of f/16 (e.g., AF 50mm f/1.4D)

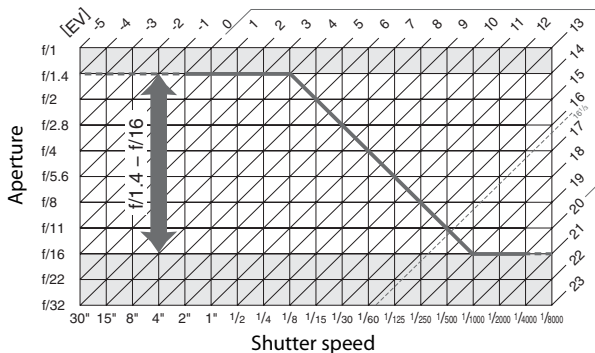

The maximum and minimum values for EV vary with ISO sensitivity; the above graph assumes an ISO sensitivity of ISO 100 equivalent. When matrix metering is used, values over $16 \frac{1}{3}$ EV are reduced to $16 \frac{1}{3}$ EV.

Troubleshooting

If the camera fails to function as expected, check the list of common problems below before consulting your retailer or Nikon-authorized service representative.

Battery/Display

The camera is on but does not respond: Wait for recording to end. If the problem persists, turn the camera off. If the camera does not turn off, remove and reinsert the battery or, if you are using an AC adapter, disconnect and reconnect the AC adapter. Note that although any data currently being recorded will be lost, data that have already been recorded will not be affected by removing or disconnecting the power source.

Viewfinder is out of focus: Adjust viewfinder focus (☐ 17). If this does not correct the problem, select single-servo AF (**AF-S**; ☐ 87), single-point AF (☐ 90), and the center focus point (☐ 94), and then frame a high-contrast subject in the center focus point and press the shutter-release button halfway to focus the camera. With the camera in focus, use the diopter adjustment control to bring the subject into clear focus in the viewfinder. If necessary, viewfinder focus can be further adjusted using optional corrective lenses (☐ 438).

Viewfinder is dark: Insert a fully-charged battery (☐ 13, 19).







Displays turn off without warning: Choose longer delays for Custom Setting c2 (**Standby timer**) or c4 (**Monitor off delay**) (☐ 319, 320).

Displays in control panel or viewfinder are unresponsive and dim: The response times and brightness of these displays vary with temperature.

Shooting



Camera takes time to turn on: Delete files or folders.

Shutter-release disabled:



- Memory card is locked (SD cards only;  22), full, or not inserted ( 14).
 - **Release locked** is selected for Custom Setting f11 (**Slot empty release lock**;  354) and no memory card is inserted ( 14).
 - Aperture ring for CPU lens not locked at highest f-number (does not apply to type G and E lenses). If **F \bar{E} E** is displayed in the control panel, select **Aperture ring** for Custom Setting f9 (**Customize command dials**) > **Aperture setting** to use lens aperture ring to adjust aperture ( 352).
 - Exposure mode **S** selected with **b \bar{u} L b** or **- -** selected for shutter speed ( 468).
-

Camera is slow to respond to shutter-release button: Select **Off** for Custom Setting d4 (**Exposure delay mode**;  322).

Only one shot taken each time shutter-release button is pressed in continuous release mode:

- Lower the built-in flash ( 107).
 - Turn HDR off ( 184).
-

Photos are out of focus:

- Rotate focus-mode selector to **AF** ( 87).
 - Camera unable to focus using autofocus: use manual focus or focus lock ( 96, 100).
-

Full range of shutter speeds not available: Flash in use. Flash sync speed can be selected using Custom Setting e1 (**Flash sync speed**); when using compatible flash units, choose **1/320 s (Auto FP)** or **1/250 s (Auto FP)** for full range of shutter speeds ( 329).

Focus does not lock when shutter-release button is pressed halfway: Camera is in focus mode **AF-C**: use **AE-L/AF-L** button to lock focus ( 96).

Can not select focus point:

- Unlock focus selector lock (□ 94).
- Auto-area AF or face-priority AF selected for AF-area mode; choose another mode (□ 40, 90).
- Camera is in playback mode (□ 235).
- Menus are in use (□ 24).
- Press shutter-release button halfway to start standby timer (□ 34).

Can not select AF mode:

- Rotate focus-mode selector to **AF** (□ 87).
- Select **No restrictions** for Custom Setting a12 (**Autofocus mode restrictions**, □ 314).

Can not select AF-area mode: Rotate focus-mode selector to **AF** (□ 87).

Image size can not be changed: **Image quality** set to **NEF (RAW)** (□ 79).

Choose image size using **NEF (RAW) recording > Image size** option in shooting menu.

Camera is slow to record photos: Turn long exposure noise reduction off (□ 299).

AF-assist illuminator does not light:

- AF-assist illuminator does not light if **AF-C** is selected for autofocus mode (□ 87). Choose **AF-S**. If an option other than auto-area AF is selected for AF-area mode, select center focus point (□ 94).
 - The camera is currently in live view or a movie is being recorded.
 - **Off** is selected for Custom Setting a10 (**Built-in AF-assist illuminator**) (□ 313).
 - Illuminator has turned off automatically. Illuminator may become hot with continued use; wait for it to cool down.
-

Live view ends unexpectedly or does not start: Live view may end automatically to prevent damage to the camera's internal circuits if:

- The ambient temperature is high
- The camera has been used for extended periods in live view or to record movies
- The camera has been used in continuous release modes for extended periods





If live view does not start when you press the  button, wait for the internal circuits to cool and then try again. Note that the camera may feel warm to the touch, but this does not indicate a malfunction.

Image artifacts appear during live view: The temperature of the camera's internal circuits may rise during live view, causing image "noise" in the form of bright spots, randomly-spaced bright pixels, or fog. Exit live view when the camera is not in use.

Flicker or banding appears during live view or movie recording: Choose an option for **Flicker reduction** that matches the frequency of the local AC power supply ( 371).

Bright bands appear during live view or movie recording: A flashing sign, flash, or other light source with brief duration was used during live view or movie recording.

Noise (bright spots, randomly-spaced bright pixels, fog, lines, or reddish areas) appears in photos:

- To reduce randomly-spaced bright pixels, fog, or lines, choose lower ISO sensitivity or use high ISO noise reduction ( 109, 299).
 - To reduce bright spots, randomly-spaced bright pixels, or fog at shutter speeds slower than 1 s or to reduce reddish areas and other artifacts in long time-exposures, enable long exposure noise reduction ( 299).
 - Turn **Active D-Lighting** off to avoid heightening the effects of noise ( 183).
-

Smudges appear in photographs: Clean front and rear lens elements. If problem persists, perform image sensor cleaning (☞ 445).

Colors are unnatural:

- Adjust white balance to match light source (☞ 148).
 - Adjust **Set Picture Control** settings (☞ 170).
-

Can not measure white balance: Subject is too dark or too bright (☞ 161).

Image can not be selected as source for preset manual white balance: Image was not created with D810 (☞ 167).

White balance bracketing unavailable:

- NEF (RAW) or NEF+JPEG image quality option selected for image quality (☞ 79).
 - Multiple exposure mode is in effect (☞ 209).
-

Effects of Picture Control differ from image to image: A (auto) is selected for sharpening, clarity, contrast, or saturation. For consistent results over a series of photographs, choose another setting (☞ 175).

Metering can not be changed: Autoexposure lock is in effect (☞ 129).

Exposure compensation can not be used: Choose exposure mode *P*, *S*, or *A* (☞ 116, 132).

Sound is not recorded with movies: **Microphone off** is selected for **Movie settings** > **Microphone sensitivity** (☞ 62).

Playback

NEF (RAW) image is not played back: Photo was taken at image quality of NEF + JPEG (☞ 80).

Can not view pictures recorded with other cameras: Pictures recorded with other makes of camera may not be displayed correctly.

Some photos are not displayed during playback: Select **All** for **Playback folder** (☞ 281).

“Tall” (portrait) orientation photos are displayed in “wide” (landscape) orientation:

- Select **On** for **Rotate tall** (☞ 288).
 - Photo was taken with **Off** selected for **Auto image rotation** (☞ 373).
 - Photo is displayed in image review (☞ 236).
 - Camera was pointed up or down when photo was taken (☞ 373).
-

Can not delete photo:

- Picture is protected: remove protection (☞ 250).
 - Memory card is locked (☞ 22).
-

Can not retouch picture: Photo can not be further edited with this camera (☞ 385).

Message is displayed stating that no images are available for playback: Select **All** for **Playback folder** (☞ 281).

Can not change print order:

- Memory card is full: delete pictures (☞ 19, 251).
 - Memory card is locked (☞ 22).
-

Can not select photo for printing: NEF (RAW) and TIFF photos can not be printed by direct USB connection. Transfer photos to computer and print using ViewNX 2 (supplied) or Capture NX-D (available for download; □ 260). NEF (RAW) photos can be saved in JPEG format using **NEF (RAW) processing** (□ 399).

Photo is not displayed on high-definition video device: Confirm that HDMI cable is connected (□ 269).

Image Dust Off option in Capture NX-D does not have desired effect: Image sensor cleaning changes the position of dust on the image sensor. Dust off reference data recorded before image sensor cleaning is performed can not be used with photographs taken after image sensor cleaning is performed. Dust off reference data recorded after image sensor cleaning is performed can not be used with photographs taken before image sensor cleaning is performed (□ 370).

Computer displays NEF (RAW) images differently from camera: Third-party software does not display effects of Picture Controls, Active D-Lighting, or vignette control. Use ViewNX 2 (supplied) or Nikon software such as Capture NX-D (available for download; □ 260).

Can not transfer photos to computer: OS not compatible with camera or transfer software. Use card reader to copy photos to computer (□ 255).

Miscellaneous

Date of recording is not correct: Set camera clock (□ 18).

Menu item can not be selected: Some options are not available at certain combinations of settings or when no memory card is inserted. Note that **Battery info** option is not available when camera is powered by an optional power connector and AC adapter (□ 374).

Error Messages

This section lists the indicators and error messages that appear in the viewfinder, control panel, and monitor.

Indicator		Problem	Solution	📖
Control panel	View-finder			
		Lens aperture ring is not set to minimum aperture.	Set ring to minimum aperture (highest f-number).	23
		Low battery.	Recharge a fully-charged spare battery.	13, 19
(flashes)	(flashes)	<ul style="list-style-type: none"> Battery exhausted. Battery can not be used. An extremely exhausted rechargeable Li-ion battery or a third-party battery is inserted either in the camera or in the optional MB-D12 battery pack. 	<ul style="list-style-type: none"> Recharge or replace battery. Contact Nikon-authorized service representative. Replace the battery, or recharge the battery if the rechargeable Li-ion battery is exhausted. 	xxi, 13, 14, 436
(flashes)	—	Camera clock is not set.	Set camera clock.	18

Indicator		Problem	Solution	📖
Control panel	Viewfinder			
	ΔF	No lens attached, or non-CPU lens attached without specifying maximum aperture. Aperture shown in stops from maximum aperture.	Aperture value will be displayed if maximum aperture is specified.	229
—	▶◀ (flashes)	Camera unable to focus using autofocus.	Change composition or focus manually.	30, 100
(Exposure indicators and shutter speed or aperture display flash)		Subject too bright; photo will be overexposed.	• Use a lower ISO sensitivity.	109
			• Use optional ND filter. In exposure mode: S Increase shutter speed A Choose a smaller aperture (higher f-number)	440 119 120
		Subject too dark; photo will be underexposed.	• Use a higher ISO sensitivity.	109
			• Use flash. In exposure mode: S Lower shutter speed A Choose a larger aperture (lower f-number)	189, 428 119 120

Indicator		Problem	Solution	📖
Control panel	View-finder			
b u l b (flashes)		b u l b selected in exposure mode S .	Change shutter speed or select manual exposure mode.	119, 121
- - (flashes)		- - selected in exposure mode S .	Change shutter speed or select manual exposure mode.	119, 121
b u s y (flashes)	b s y (flashes)	Processing in progress.	Wait until processing is complete.	—
—	 (flashes)	If indicator flashes for 3s after flash fires, photo may be underexposed.	Check photo in monitor; if underexposed, adjust settings and try again.	195
F u l l CF/SD (flashes)	F u l (flashes)	Memory insufficient to record further photos at current settings, or camera has run out of file or folder numbers.	<ul style="list-style-type: none"> • Reduce quality or size. • Delete photographs after copying important images to computer or other device. • Insert new memory card. 	79, 83 251 14
E r r (flashes)		Camera malfunction.	Release shutter. If error persists or appears frequently, consult Nikon-authorized service representative.	—

The **CF** and **SD** Icons

These icons flash to show the card affected.

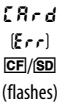
Indicator		Problem	Solution	
Monitor	Control panel			
No memory card.	(-E-)	Camera cannot detect memory card.	Turn camera off and confirm that card is correctly inserted.	14
This memory card cannot be used. Card may be damaged. Insert another card.	 Card Error CF/SD (flashes)	<ul style="list-style-type: none"> • Error accessing memory card. 	<ul style="list-style-type: none"> • Use Nikon-approved card. • Check that contacts are clean. If card is damaged, contact retailer or Nikon-authorized service representative. 	487
		<ul style="list-style-type: none"> • Unable to create new folder. 	<ul style="list-style-type: none"> • Delete files or insert new memory card after copying important images to computer or other device. 	—

Indicator		Problem	Solution	📖
Monitor	Control panel			
	[Err], (flashes)	Camera can not control Eye-Fi card.	<ul style="list-style-type: none"> • Check that Eye-Fi card firmware is up to date. • Copy files on Eye-Fi card to a computer or other device and format card, or insert new card. 	383 14,253
Memory card is locked. Slide lock to “write” position.	[Err], (flashes)	Memory card is locked (write protected).	Slide card write-protect switch to “write” position.	22
Not available if Eye-Fi card is locked.	[Err], (flashes)	Eye-Fi card is locked (write protected).		
This card is not formatted. Format the card.	[Fcr] (flashes)	Memory card has not been formatted for use in camera.	Format memory card or insert new memory card.	14,366
Unable to start live view. Please wait.	—	The internal temperature of the camera is high.	Wait for the internal circuits to cool before resuming live view or movie recording.	47,61

Indicator		Problem	Solution	📖
Monitor	Control panel			
Folder contains no images.	—	No images on memory card or in folder(s) selected for playback.	Select folder containing images from Playback folder menu or insert memory card containing images.	14, 281
All images are hidden.	—	All photos in current folder are hidden.	No images can be played back until another folder has been selected or Hide image used to allow at least one image to be displayed.	281
Cannot display this file.	—	File has been created or modified using a computer or different make of camera, or file is corrupt.	File can not be played back on camera.	—
Cannot select this file.	—	Selected image can not be retouched.	Images created with other devices can not be retouched.	385

Indicator		Problem	Solution	📖
Monitor	Control panel			
Check printer.	—	Printer error.	Check printer. To resume, select Continue (if available).	263*
Check paper.	—	Paper in printer is not of selected size.	Insert paper of correct size and select Continue .	263*
Paper jam.	—	Paper is jammed in printer.	Clear jam and select Continue .	263*
Out of paper.	—	Printer is out of paper.	Insert paper of selected size and select Continue .	263*
Check ink supply.	—	Ink error.	Check ink. To resume, select Continue .	263*
Out of ink.	—	Printer is out of ink.	Replace ink and select Continue .	263*

* See printer manual for more information.

Specifications

■ Nikon D810 Digital Camera

Type	
Type	Single-lens reflex digital camera
Lens mount	Nikon F mount (with AF coupling and AF contacts)
Effective angle of view	Nikon FX format
Effective pixels	
Effective pixels	36.3 million
Image sensor	
Image sensor	35.9 × 24.0 mm CMOS sensor
Total pixels	37.09 million
Dust-reduction System	Image sensor cleaning, Image Dust Off reference data (Capture NX-D software required)
Storage	
Image size (pixels)	<ul style="list-style-type: none">• FX (36×24) image area 7360×4912 (L) 5520×3680 (M) 3680×2456 (S)• 1.2× (30×20) image area 6144×4080 (L) 4608×3056 (M) 3072×2040 (S)• DX (24×16) image area 4800×3200 (L) 3600×2400 (M) 2400×1600 (S)• 5 : 4 (30×24) image area 6144×4912 (L) 4608×3680 (M) 3072×2456 (S)

Storage	
Image size (pixels)	<ul style="list-style-type: none"> • FX-format photographs taken in movie live view 6720×3776 (L) 5040×2832 (M) 3360×1888 (S) • DX-format photographs taken in movie live view 4800×2704 (L) 3600×2024 (M) 2400×1352 (S) <p>Note: Photographs taken in movie live view have an aspect ratio of 16 : 9. A DX-based format is used for photographs taken using the DX (24 × 16) 1.5× image area; an FX-based format is used for all other photographs.</p>
File format	<ul style="list-style-type: none"> • NEF (RAW): 12 or 14 bit, lossless compressed, compressed, or uncompressed; small size available (12-bit uncompressed only) • TIFF (RGB) • JPEG: JPEG-Baseline compliant with fine (approx. 1 : 4), normal (approx. 1 : 8), or basic (approx. 1 : 16) compression (Size priority); Optimal quality compression available • NEF (RAW)+JPEG: Single photograph recorded in both NEF (RAW) and JPEG formats
Picture Control System	Standard, Neutral, Vivid, Monochrome, Portrait, Landscape, Flat; selected Picture Control can be modified; storage for custom Picture Controls
Media	SD (Secure Digital) and UHS-I compliant SDHC and SDXC memory cards; Type I CompactFlash memory cards (UDMA compliant)
Dual card slots	Either card can be used for primary or backup storage or for separate storage of NEF (RAW) and JPEG images; pictures can be copied between cards.
File system	DCF 2.0, DPOF, Exif 2.3, PictBridge

Viewfinder	
Viewfinder	Eye-level pentaprism single-lens reflex viewfinder
Frame coverage	<ul style="list-style-type: none"> • FX (36×24): Approx. 100% horizontal and 100% vertical • 1.2× (30×20): Approx. 97% horizontal and 97% vertical • DX (24×16): Approx. 97% horizontal and 97% vertical • 5:4 (30×24): Approx. 97% horizontal and 100% vertical
Magnification	Approx. $0.7 \times$ (50 mm f/1.4 lens at infinity, -1.0 m^{-1})
Eyepoint	17 mm (-1.0 m^{-1} ; from center surface of viewfinder eyepiece lens)
Diopter adjustment	-3 – $+1 \text{ m}^{-1}$
Focusing screen	Type B BriteView Clear Matte Mark VIII screen with AF area brackets (framing grid can be displayed)
Reflex mirror	Quick return
Depth-of-field preview	Pressing Pv button stops lens aperture down to value selected by user (A and M modes) or by camera (P and S modes)
Lens aperture	Instant return, electronically controlled
Lens	
Compatible lenses	<p>Compatible with AF NIKKOR lenses, including type G, E, and D lenses (some restrictions apply to PC lenses) and DX lenses (using DX 24 × 16 1.5× image area), AI-P NIKKOR lenses, and non-CPU AI lenses (exposure modes A and M only). IX NIKKOR lenses, lenses for the F3AF, and non-AI lenses can not be used.</p> <p>The electronic rangefinder can be used with lenses that have a maximum aperture of f/5.6 or faster (the electronic rangefinder supports the 11 focus points with lenses that have a maximum aperture of f/8 or faster).</p>

Shutter	
Type	Electronically-controlled vertical-travel focal-plane mechanical shutter; electronic front-curtain shutter available in mirror up release mode
Speed	$\frac{1}{8000}$ – 30 s in steps of $\frac{1}{3}$, $\frac{1}{2}$, or 1 EV, bulb, time, X250
Flash sync speed	X= $\frac{1}{250}$ s; synchronizes with shutter at $\frac{1}{320}$ s or slower (flash range drops at speeds between $\frac{1}{250}$ and $\frac{1}{320}$ s)
Release	
Release mode	S (single frame), CL (continuous low speed), CH (continuous high speed), Q (quiet shutter-release), Qc (quiet continuous shutter-release), ⌚ (self-timer), MUP (mirror up)
Approximate frame advance rate	<p>With EN-EL15 batteries</p> <ul style="list-style-type: none"> • Image area: FX/5 : 4 <ul style="list-style-type: none"> - CL: 1–5 fps - CH: 5 fps - Qc: 3 fps • Image area: DX/1.2× <ul style="list-style-type: none"> - CL: 1–6 fps - CH: 6 fps - Qc: 3 fps <p>Other power sources</p> <ul style="list-style-type: none"> • Image area: FX/5 : 4 <ul style="list-style-type: none"> - CL: 1–5 fps - CH: 5 fps - Qc: 3 fps • Image area: DX <ul style="list-style-type: none"> - CL: 1–6 fps - CH: 7 fps - Qc: 3 fps • Image area: 1.2× <ul style="list-style-type: none"> - CL: 1–6 fps - CH: 6 fps - Qc: 3 fps
Self-timer	2 s, 5 s, 10 s, 20 s; 1–9 exposures at intervals of 0.5, 1, 2, or 3 s

Exposure	
Metering	TTL exposure metering using RGB sensor with approximately 91K (91,000) pixels
Metering method	<ul style="list-style-type: none"> • Matrix: 3D color matrix metering III (type G, E, and D lenses); color matrix metering III (other CPU lenses); color matrix metering available with non-CPU lenses if user provides lens data • Center-weighted: Weight of approximately 75% given to 12 mm circle in center of frame. Diameter of circle can be changed to 8, 15, or 20 mm, or weighting can be based on average of entire frame (non-CPU lenses use 12-mm circle) • Spot: Meters 4 mm circle (about 1.5% of frame) centered on selected focus point (on center focus point when non-CPU lens is used) • Highlight-weighted: Available with type G, E, and D lenses; equivalent to center-weighted when other lenses are used.
Range (ISO 100, f/1.4 lens, 20 °C/68 °F)	<ul style="list-style-type: none"> • Matrix, center-weighted, or highlight-weighted metering: 0–20 EV • Spot metering: 2–20 EV
Exposure meter coupling	Combined CPU and AI
Exposure mode	Programmed auto with flexible program (P); shutter-priority auto (S); aperture-priority auto (A); manual (M)
Exposure compensation	–5 – +5 EV in increments of $\frac{1}{3}$, $\frac{1}{2}$, or 1 EV
Exposure bracketing	2–9 frames in steps of $\frac{1}{3}$, $\frac{1}{2}$, $\frac{2}{3}$, or 1 EV; 2–5 frames in steps of 2 or 3 EV
Flash bracketing	2–9 frames in steps of $\frac{1}{3}$, $\frac{1}{2}$, $\frac{2}{3}$, or 1 EV; 2–5 frames in steps of 2 or 3 EV
White balance bracketing	2–9 frames in steps of 1, 2, or 3

Exposure	
ADL bracketing	2 frames using selected value for one frame or 3–5 frames using preset values for all frames
Exposure lock	Luminosity locked at detected value with ^{AE-L} _{AF-L} AE-L/AF-L button
ISO sensitivity (Recommended Exposure Index)	ISO 64 – 12800 in steps of $\frac{1}{3}$, $\frac{1}{2}$, or 1 EV. Can also be set to approx. 0.3, 0.5, 0.7, or 1 EV (ISO 32 equivalent) below ISO 64 or to approx. 0.3, 0.5, 0.7, 1, or 2 EV (ISO 51200 equivalent) above ISO 12800; auto ISO sensitivity control available
Active D-Lighting	Can be selected from Auto , Extra high , High , Normal , Low , or Off
Focus	
Autofocus	Nikon Advanced Multi-CAM 3500FX autofocus sensor module with TTL phase detection, fine-tuning, 51 focus points (including 15 cross-type sensors; f/8 supported by 11 sensors), and AF-assist illuminator (range approx. 0.5–3 m/1 ft 8 in.–9 ft 10 in.)
Detection range	–2 – +19 EV (ISO 100, 20 °C/68 °F)
Lens servo	<ul style="list-style-type: none"> • Autofocus (AF): Single-servo AF (AF-S); continuous-servo AF (AF-C); predictive focus tracking automatically activated according to subject status • Manual focus (M): Electronic rangefinder can be used
Focus point	Can be selected from 51 or 11 focus points
AF-area mode	Single-point AF, 9-, 21-, or 51-point dynamic-area AF, 3D-tracking, group-area AF, auto-area AF
Focus lock	Focus can be locked by pressing shutter-release button halfway (single-servo AF) or by pressing ^{AE-L} _{AF-L} AE-L/AF-L button

Flash	
Built-in flash	Manual pop-up with button release and a Guide Number of 12/39, 12/39 with manual flash (m/ft, ISO 100, 20 °C/68 °F)
Flash control	TTL: i-TTL flash control using RGB sensor with approximately 91K (91,000) pixels is available with built-in flash; i-TTL balanced fill-flash for digital SLR is used with matrix, center-weighted, and highlight-weighted metering, standard i-TTL flash for digital SLR with spot metering
Flash mode	Front curtain sync, slow sync, rear-curtain sync, red-eye reduction, red-eye reduction with slow sync, slow rear-curtain sync, off; Auto FP High-Speed Sync supported
Flash compensation	-3 – +1 EV in increments of $\frac{1}{3}$, $\frac{1}{2}$, or 1 EV
Flash-ready indicator	Lights when built-in flash or optional flash unit is fully charged; blinks after flash is fired at full output
Accessory shoe	ISO 518 hot-shoe with sync and data contacts and safety lock
Nikon Creative Lighting System (CLS)	Nikon CLS supported; commander mode option available
Sync terminal	ISO 519 sync terminal with locking thread
White balance	
White balance	Auto (2 types), incandescent, fluorescent (7 types), direct sunlight, flash, cloudy, shade, preset manual (up to 6 values can be stored, spot white balance measurement available during live view), choose color temperature (2500 K–10,000 K), all with fine-tuning

Live view	
Modes	Live view photography (still images), movie live view (movies)
Lens servo	<ul style="list-style-type: none"> • Autofocus (AF): Single-servo AF (AF-S); full-time servo AF (AF-F) • Manual focus (M)
AF-area mode	Face-priority AF, wide-area AF, normal-area AF, subject-tracking AF
Autofocus	Contrast-detect AF anywhere in frame (camera selects focus point automatically when face-priority AF or subject-tracking AF is selected)
Movie	
Metering	TTL exposure metering using main image sensor
Metering method	Matrix, center-weighted, or highlight-weighted
Frame size (pixels) and frame rate	<ul style="list-style-type: none"> • 1920×1080; 60 p (progressive), 50 p, 30 p, 25 p, 24 p • 1280×720; 60 p, 50 p <p>Actual frame rates for 60 p, 50 p, 30 p, 25 p, and 24 p are 59.94, 50, 29.97, 25, and 23.976 fps respectively; options support both ★high and normal image quality</p>
File format	MOV
Video compression	H.264/MPEG-4 Advanced Video Coding
Audio recording format	Linear PCM
Audio recording device	Built-in or external stereo microphone; sensitivity adjustable

Movie	
ISO sensitivity	<ul style="list-style-type: none"> • Exposure modes P, S, and A: Auto ISO sensitivity control (ISO 64 to Hi 2) with selectable upper limit • Exposure mode M: Auto ISO sensitivity control (ISO 64 to Hi 2) available with selectable upper limit; manual selection (ISO 64 to 12800 in steps of $\frac{1}{3}$, $\frac{1}{2}$, or 1 EV) with additional options available equivalent to approximately 0.3, 0.5, 0.7, 1, or 2 EV (ISO 51200 equivalent) above ISO 12800
Other options	Index marking, time-lapse photography
Monitor	
Monitor	8-cm/3.2-in., approx. 1229 k-dot (VGA; 640 × RGBW × 480 = 1,228,800 dots), TFT monitor with 170 ° viewing angle, approx. 100% frame coverage, and brightness adjustment
Playback	
Playback	Full-frame and thumbnail (4, 9, or 72 images) playback with playback zoom, movie playback, photo and/or movie slide shows, histogram display, highlights, photo information, location data display, and auto image rotation

Interface	
USB	SuperSpeed USB (USB 3.0 Micro-B connector); connection to built-in USB port is recommended
HDMI output	Type C HDMI connector
Audio input	Stereo mini-pin jack (3.5 mm diameter; plug-in power supported)
Audio output	Stereo mini-pin jack (3.5 mm diameter)
Ten-pin remote terminal	Can be used to connect optional remote control, optional WR-R10 (requires WR-A10 adapter) or WR-1 wireless remote controller, GP-1/GP-1A GPS unit, or GPS device compliant with NMEA0183 version 2.01 or 3.01 (requires optional MC-35 GPS adapter cord and cable with D-sub 9-pin connector)
Supported languages	
Supported languages	Arabic, Bengali, Bulgarian, Chinese (Simplified and Traditional), Czech, Danish, Dutch, English, Finnish, French, German, Greek, Hindi, Hungarian, Indonesian, Italian, Japanese, Korean, Marathi, Norwegian, Persian, Polish, Portuguese (Portugal and Brazil), Romanian, Russian, Serbian, Spanish, Swedish, Tamil, Telugu, Thai, Turkish, Ukrainian, Vietnamese

Power source	
Battery	One rechargeable Li-ion EN-EL15 battery
Battery pack	Optional MB-D12 multi-power battery pack with one rechargeable Nikon EN-EL18a or EN-EL18 Li-ion battery (available separately), one rechargeable Nikon EN-EL15 Li-ion battery, or eight AA alkaline, Ni-MH, or lithium batteries. A BL-5 battery-chamber cover is required when using EN-EL18a or EN-EL18 batteries.
AC adapter	EH-5b AC adapter; requires EP-5B power connector (available separately)

Tripod socket	
Tripod socket	1/4 in. (ISO 1222)

Dimensions/weight	
Dimensions (W × H × D)	Approx. 146 × 123 × 81.5 mm (5.8 × 4.9 × 3.3 in.)
Weight	Approx. 980 g (2 lb 2.6 oz) with battery and SD memory card but without body cap; approx. 880 g/1 lb 15.1 oz (camera body only)

Operating environment	
Temperature	0 °C–40 °C (+32 °F–104 °F)
Humidity	85% or less (no condensation)

- Unless otherwise stated, all figures are for a camera with a fully-charged battery operating at the temperature specified by the Camera and Imaging Products Association (CIPA): 23 ±3 °C (73.4 ±5.4 °F).
- Nikon reserves the right to change the specifications of the hardware and software described in this manual at any time and without prior notice. Nikon will not be held liable for damages that may result from any mistakes that this manual may contain.

MH-25a Battery Charger

Rated input (in North America)	AC 120 V, 60 Hz, 0.2 A
Rated input (in other regions)	AC 100–240 V, 50/60 Hz, 0.23–0.12 A
Rated output	DC 8.4 V/1.2 A
Supported batteries	Nikon EN-EL15 rechargeable Li-ion batteries
Charging time	Approx. 2 hours and 35 minutes at an ambient temperature of 25 °C (77 °F) when no charge remains
Operating temperature	0 °C–40 °C (+32 °F–104 °F)
Dimensions (W × H × D)	Approx. 95 × 33.5 × 71 mm (3.7 × 1.3 × 2.8 in.), excluding projections
Length of power cable (if supplied)	Approx. 1.5 m (4.9 ft)
Weight	Approx. 115 g (4.1 oz), excluding supplied power connector (power cable or AC wall adapter)

EN-EL15 Rechargeable Li-ion Battery

Type	Rechargeable lithium-ion battery
Rated capacity	7.0 V, 1900 mAh
Operating temperature	0 °C–40 °C (+32 °F–104 °F)
Dimensions (W × H × D)	Approx. 40 × 56 × 20.5 mm (1.6 × 2.2 × 0.8 in.)
Weight	Approx. 88 g (3.1 oz), excluding terminal cover

- Nikon reserves the right to change the specifications of the hardware and software described in this manual at any time and without prior notice. Nikon will not be held liable for damages that may result from any mistakes that this manual may contain.

Supported Standards

- **DCF Version 2.0:** The Design Rule for Camera File System (DCF) is a standard widely used in the digital camera industry to ensure compatibility among different makes of camera.
- **DPOF:** Digital Print Order Format (DPOF) is an industry-wide standard that allows pictures to be printed from print orders stored on the memory card.
- **Exif version 2.3:** The camera supports Exif (**Exchangeable Image File Format for Digital Still Cameras**) version 2.3, a standard in which information stored with photographs is used for optimal color reproduction when the images are output on Exif-compliant printers.
- **PictBridge:** A standard developed through cooperation with the digital camera and printer industries, allowing photographs to be output directly to a printer without first transferring them to a computer.
- **HDMI:** High-Definition Multimedia Interface is a standard for multimedia interfaces used in consumer electronics and AV devices capable of transmitting audiovisual data and control signals to HDMI-compliant devices via a single cable connection.

Trademark Information

Mac and OS X are registered trademarks of Apple Inc. in the United States and/or other countries. Microsoft, Windows and Windows Vista are either registered trademarks, or trademarks of Microsoft Corporation in the United States and/or other countries. PictBridge is a trademark. The SD, SDHC, and SDXC logos are trademarks of the SD-3C, LLC. CompactFlash is a trademark of SanDisk Corporation. HDMI, the HDMI logo and High-Definition Multimedia Interface are trademarks or registered trademarks of HDMI Licensing, LLC.

HDMI

All other trade names mentioned in this manual or the other documentation provided with your Nikon product are trademarks or registered trademarks of their respective holders.

FreeType License (FreeType2)

Portions of this software are copyright © 2012 The FreeType Project (<http://www.freetype.org>). All rights reserved.

MIT License (HarfBuzz)

Portions of this software are copyright © 2014 The HarfBuzz Project (<http://www.freedesktop.org/wiki/Software/HarfBuzz>). All rights reserved.

Approved Memory Cards

The camera accepts the SD and CompactFlash memory cards listed in the following sections. Other cards have not been tested. For more details on the cards listed below, please contact the manufacturer.

■ SD Memory Cards

The following cards have been tested and approved for use in the camera. Cards with class 6 or faster write speeds are recommended for movie recording. Recording may end unexpectedly when cards with slower write speeds are used.

	SD cards	SDHC cards ²	SDXC cards ³
SanDisk	2 GB ¹	4 GB, 8 GB, 16 GB, 32 GB	64 GB, 128 GB
Toshiba	—		64 GB
Panasonic	2 GB ¹	4 GB, 6 GB, 8 GB, 12 GB, 16 GB, 24 GB, 32 GB	48 GB, 64 GB
Lexar Media		4 GB, 8 GB, 16 GB, 32 GB	—
Platinum II	—	8 GB, 16 GB, 32 GB	64 GB
Professional			64 GB, 128 GB, 256 GB
Full-HD Video		4 GB, 8 GB, 16 GB	—

- 1 Check that any card readers or other devices with which the card will be used support 2 GB cards.
- 2 Check that any card readers or other devices with which the card will be used are SDHC-compliant. The camera supports UHS-1.
- 3 Check that any card readers or other devices with which the card will be used are SDXC-compliant. The camera supports UHS-1.



■ CompactFlash Memory Cards

The following Type I CompactFlash memory cards have been tested and approved for use in the camera. Cards with a write speed of 30 MB/s (200×) are recommended for movie recording. At slower speeds, movies may not play back smoothly and recording may end unexpectedly. Type II cards and microdrives can not be used.

SanDisk	Extreme Pro	SDCFXPS	16 GB, 32 GB, 64 GB, 128 GB, 256 GB
		SDCFXP	16 GB, 32 GB, 64 GB, 128 GB
	Extreme	SDCFXS	8 GB, 16 GB, 32 GB, 64 GB, 128 GB
		SDCFX	8 GB, 16 GB, 32 GB, 64 GB
	Extreme IV	SDCFX4	2 GB, 4 GB, 8 GB, 16 GB
	Extreme III	SDCFX3	2 GB, 4 GB, 8 GB, 16 GB
	Ultra II	SDCFH	2 GB, 4 GB, 8 GB
	Ultra	SDCFHS	4 GB, 8 GB, 16 GB
SDCFHG		4 GB, 8 GB, 16 GB	
Lexar Media	Professional UDMA	1066 ×	16 GB, 32 GB, 64 GB, 128 GB, 256 GB
		1000 ×	16 GB, 32 GB, 128 GB, 256 GB
		800 ×	8 GB, 16 GB, 32 GB, 64 GB, 128 GB
		600 ×	8 GB, 16 GB, 32 GB
		400 ×	8 GB, 16 GB, 32 GB, 64 GB, 128 GB
		300 ×	2 GB, 4 GB, 8 GB, 16 GB
	Professional	233 ×	2 GB, 4 GB, 8 GB
		133 ×	2 GB, 4 GB, 8 GB
		80 ×	2 GB, 4 GB
	Platinum II	200 ×	4 GB, 8 GB, 16 GB
		80 ×	2 GB, 4 GB, 8 GB, 16 GB
		60 ×	4 GB

Memory Card Capacity

The following table shows the approximate number of pictures that can be stored on a 16 GB SanDisk SDCFXPS-016G-J92 card at different image quality (📖 79), image size (📖 83), and image area settings (📖 74).

■ FX (36×24) Image Area*

Image quality	Image size	File size ¹	No. of images ¹	Buffer capacity ²
NEF (RAW), Lossless compressed, 12-bit	Large	31.9 MB	257	47
NEF (RAW), Lossless compressed, 14-bit	Large	40.7 MB	199	28
NEF (RAW), Compressed, 12-bit	Large	29.2 MB	348	58
NEF (RAW), Compressed, 14-bit	Large	36.3 MB	291	35
NEF (RAW), Uncompressed, 12-bit	Large	55.9 MB	257	34
	Small	27.9 MB	516	18
NEF (RAW), Uncompressed, 14-bit	Large	73.2 MB	199	23
TIFF (RGB)	Large	107.2 MB	137	25
	Medium	60.9 MB	242	34
	Small	27.9 MB	526	72
JPEG fine ³	Large	18.1 MB	642	100
	Medium	11.0 MB	1000	100
	Small	5.6 MB	2100	100
JPEG normal ³	Large	9.4 MB	1200	100
	Medium	5.5 MB	2100	100
	Small	2.8 MB	4200	100
JPEG basic ³	Large	3.2 MB	2400	100
	Medium	2.2 MB	4100	100
	Small	1.4 MB	7800	100

* Includes images taken with non-DX lenses when **On** is selected for **Auto DX crop**.

■ DX (24×16) Image Area*

Image quality	Image size	File size ¹	No. of images ¹	Buffer capacity ²
NEF (RAW), Lossless compressed, 12-bit	Large	14.6 MB	580	100
NEF (RAW), Lossless compressed, 14-bit	Large	18.3 MB	453	97
NEF (RAW), Compressed, 12-bit	Large	13.3 MB	777	100
NEF (RAW), Compressed, 14-bit	Large	16.4 MB	653	100
NEF (RAW), Uncompressed, 12-bit	Large	24.4 MB	580	78
	Small	16.4 MB	1100	23
NEF (RAW), Uncompressed, 14-bit	Large	31.8 MB	453	46
	Large	46.2 MB	317	39
	Medium	26.6 MB	549	75
TIFF (RGB)	Small	12.4 MB	1100	100
	Large	8.6 MB	1400	100
	Medium	5.3 MB	2200	100
JPEG fine ³	Small	2.9 MB	4000	100
	Large	4.4 MB	2700	100
	Medium	2.7 MB	4300	100
JPEG normal ³	Small	1.5 MB	7600	100
	Large	1.7 MB	5200	100
	Medium	1.3 MB	8100	100
JPEG basic ³	Small	0.9 MB	13,200	100

* Includes images taken with DX lenses when **On** is selected for **Auto DX crop**.

- 1 All figures are approximate. File size varies with scene recorded.
- 2 Maximum number of exposures that can be stored in memory buffer at ISO 100. Drops if **Optimal quality** is selected for **JPEG/TIFF recording > JPEG compression**, ISO sensitivity is set to Hi 0.3 or higher, or auto distortion control or long exposure noise reduction is on.
- 3 Figures assume **JPEG/TIFF recording > JPEG compression** is set to **Size priority**. Selecting **Optimal quality** increases the file size of JPEG images; number of images and buffer capacity drop accordingly.

 **d3—Max. Continuous Release** (☐ 322)

The maximum number of photographs that can be taken in a single burst can be set to any amount between 1 and 100.

Battery Life

The movie footage or number of shots that can be recorded with fully-charged batteries varies with the condition of the battery, temperature, interval between shots, and the length of time menus are displayed. In the case of AA batteries, capacity also varies with make and storage conditions; some batteries can not be used. Sample figures for the camera and optional MB-D12 multi-power battery pack are given below.

- **Photographs, single-frame release mode (CIPA standard¹)**
 - **One EN-EL15 battery (camera):** Approximately 1200 shots
 - **One EN-EL15 battery (MB-D12):** Approximately 1200 shots
 - **One EN-EL18a battery (MB-D12):** Approximately 2070 shots
 - **Eight AA alkaline batteries (MB-D12):** Approximately 1460 shots
- **Photographs, continuous release mode (Nikon standard²)**
 - **One EN-EL15 battery (camera):** Approximately 3860 shots
 - **One EN-EL15 battery (MB-D12):** Approximately 3860 shots
 - **One EN-EL18a battery (MB-D12):** Approximately 6980 shots
 - **Eight AA alkaline batteries (MB-D12):** Approximately 4060 shots
- **Movies³**
 - **One EN-EL15 battery (camera):** Approximately 40 minutes of HD footage
 - **One EN-EL15 battery (MB-D12):** Approximately 40 minutes of HD footage
 - **One EN-EL18a battery (MB-D12):** Approximately 80 minutes of HD footage
 - **Eight AA alkaline batteries (MB-D12):** Approximately 50 minutes of HD footage

- 1 Measured at 23 °C/73.4 °F (± 2 °C/3.6 °F) with an AF-S NIKKOR 24–120mm f/4G ED VR lens under the following test conditions: lens cycled from infinity to minimum range and one photograph taken at default settings once every 30 s; flash fired once every other shot. Live view not used.
- 2 Measured at 20 °C/68 °F with an AF-S NIKKOR 70–200mm f/2.8G ED VR II lens under the following test conditions: vibration reduction off, image quality set to JPEG normal, image size set to **Large**, shutter speed $\frac{1}{250}$ s, focus cycled from infinity to minimum range three times after shutter-release button has been pressed halfway for 3 s; six shots are then taken in succession and monitor turned on for 5 s and then turned off; cycle repeated once standby timer has expired.
- 3 Measured at 23 °C/73.4 °F (± 3 °C/5.4 °F) with the camera at default settings and an AF-S NIKKOR 24–120mm f/4G ED VR lens under conditions specified by the Camera and Imaging Products Association (CIPA). Individual movies can be up to 20 minutes (1080/60p) in length or 4 GB in size; recording may end before these limits are reached if the camera temperature rises.

The following can reduce battery life:

- Using the monitor
- Keeping the shutter-release button pressed halfway
- Repeated autofocus operations
- Taking NEF (RAW) or TIFF (RGB) photographs
- Slow shutter speeds
- Using an optional UT-1 communication unit or WT-5 wireless transmitter
- Using a GP-1 or GP-1A GPS unit
- Using a WR-R10/WR-1 wireless remote controller or ML-3 modulite remote control set
- Using VR (vibration reduction) mode with VR lenses

To ensure that you get the most from rechargeable Nikon EN-EL15 batteries:

- Keep the battery contacts clean. Soiled contacts can reduce battery performance.
- Use batteries immediately after charging. Batteries will lose their charge if left unused.

Lenses That May Block the Built-in Flash and AF-Assist Illuminator

The lenses listed in this section may block the built-in flash or AF-assist illuminator under some conditions.

■ *AF-Assist Illumination*

AF-assist illumination is not available with the following lenses:

- AF-S VR Nikkor 200mm f/2G IF-ED
- AF-S NIKKOR 200mm f/2G ED VR II
- AF-S VR Zoom-Nikkor 200–400mm f/4G IF-ED
- AF-S NIKKOR 200–400mm f/4G ED VR II
- AF-S NIKKOR 300mm f/2.8G ED VR II

The other lenses in this section may block the AF-assist illuminator at short ranges, interfering with autofocus when lighting is poor. The following may block the illuminator at ranges under 0.7 m (2 ft 4 in.):

- AF Micro-Nikkor 200mm f/4D IF-ED

The following may block the illuminator at ranges under 1.1 m (3 ft 8 in.):

- AF-S DX NIKKOR 18–300mm f/3.5–5.6G ED VR
- AF-S NIKKOR 28–300mm f/3.5–5.6G ED VR
- AF-S DX Zoom-Nikkor 55–200mm f/4–5.6G ED
- AF-S NIKKOR 70–200mm f/4G ED VR

The following may block the illuminator at ranges under 1.5 m (5 ft):

- AF-S DX NIKKOR 55–300mm f/4.5–5.6G ED VR
- AF-S VR Zoom-Nikkor ED 70–200mm f/2.8G (IF)
- AF-S NIKKOR 70–200mm f/2.8G ED VR II
- AF Zoom-Nikkor 70–300mm f/4–5.6G
- AF Zoom-Nikkor 80–200mm f/2.8D ED
- AF-S Zoom-Nikkor 80–200mm f/2.8D IF-ED
- AF-S NIKKOR 80–400mm f/4.5–5.6G ED VR

The following may block the illuminator at ranges under 2.3 m (7 ft 7 in.):

- AF VR Zoom-Nikkor 80–400mm f/4.5–5.6D ED

■ The Built-in Flash

The built-in flash may be unable to light the entire subject with the following lenses at ranges less than those given below:

	Lens	Zoom position	Minimum distance without vignetting
DX	AF-S DX Zoom-Nikkor 12–24mm f/4G IF-ED	18–24 mm	No vignetting
	AF-S DX Zoom-Nikkor 17–55mm f/2.8G IF-ED	20 mm	1.5 m/5 ft
		24–55 mm	No vignetting
	AF-S DX NIKKOR 18–300mm f/3.5–5.6G ED VR	28 mm	No vignetting
FX	AF-S NIKKOR 16–35mm f/4G ED VR	35 mm	1.0 m/3 ft 4 in.
	AF-S Zoom-Nikkor 17–35mm f/2.8D IF-ED	28 mm	1.0 m/3 ft 4 in.
		35 mm	No vignetting
	AF Zoom-Nikkor 18–35mm f/3.5–4.5D IF-ED	24 mm	1.0 m/3 ft 4 in.
		28–35 mm	No vignetting
	AF Zoom-Nikkor 20–35mm f/2.8D IF	24 mm	1.0 m/3 ft 4 in.
		28–35 mm	No vignetting
	AF-S NIKKOR 24–70mm f/2.8G ED	35 mm	1.0 m/3 ft 4 in.
		50–70 mm	No vignetting
	AF-S VR Zoom-Nikkor 24–120mm f/3.5–5.6G IF-ED	24 mm	1.0 m/3 ft 4 in.
		28–120 mm	No vignetting
	AF-S NIKKOR 24–120mm f/4G ED VR	28 mm	1.0 m/3 ft 4 in.
		35–120 mm	No vignetting
	AF-S Zoom-Nikkor 28–70mm f/2.8D IF-ED	35 mm	1.0 m/3 ft 4 in.
50–70 mm		No vignetting	
AF-S NIKKOR 28–300mm f/3.5–5.6G ED VR	35 mm	1.0 m/3 ft 4 in.	
	50–300 mm	No vignetting	
	PC-E NIKKOR 24mm f/3.5D ED *	24 mm	1.5 m/5 ft



















* When not shifted or tilted.









When used with the AF-S NIKKOR 14–24mm f/2.8G ED, the flash will be unable to light the entire subject at all ranges.

The built-in flash can also be used with AI-S, AI-, AI-modified NIKKOR, and Nikon Series E non-CPU lenses with a focal length of 24–300mm. AI 50–300mm f/4.5, modified AI 50–300mm f/4.5, and AI-S 50–300mm f/4.5 ED lenses must be used at a zoom position of 180mm or above, and AI 50–300mm f/4.5 ED lenses at a zoom position of 135mm or above.

Index

Symbols

P (Programmed auto)	118
P* (Flexible program indicator) ..	118
S (Shutter-priority auto)	119
A (Aperture-priority auto)	120
M (Manual)	121
S	102
CL	102, 321
CH	102
Q	102
Qc	102
 (Self-timer)	103, 106
MUP	103, 108
 (Single-point AF)	90
 (Dynamic-area AF)	90
 (Auto-area AF)	91
 (Face-priority AF)	40
 (Wide-area AF)	40
 (Normal-area AF)	40
 (Subject-tracking AF)	40
 (Matrix)	114
 (Center-weighted)	114, 317
 (Spot)	114
 (Info) button	8, 201
 (Live view) button	35, 49
i button	4, 9, 42, 55, 205
 button	1, 115
? (Help)	25
 switch	16, 341
 (Focus indicator)	30, 96, 101
X (Flash sync indicator)	329
WB* (White balance fine-tuning) 153	
 (HDR indicator)	185
 (Multiple exposure indicator) 210	
P (PC mode indicator)	441
f (Aperture stop indicator)	120, 424

 (Flash compensation indicator) ..	196
 (Satellite signal indicator)	233
 (Shutter-speed lock icon)	126
 (Aperture lock icon)	127
 (HDR (series) indicator)	188
 (Multiple exposure (series) indicator)	211
CLOCK	5
	203
INTVL (Interval timer indicator)	219
INTVL (Time-lapse indicator)	227
BP (MB-D12 battery indicator)	328
-- (Time-lapse recording indicator) ..	227
 ("Beep" indicator)	321
ISO-AUTO (Auto ISO sensitivity indicator)	112
BKT (Bracketing indicator) ... 134, 139,	144
 (Exposure compensation indicator)	131
PRE (Preset manual)	148, 158

Numerics

1.2x (30 × 20) 1.2x	75
12-bit	82
14-bit	82
3D color matrix metering III	114
3D-tracking	90, 92
5 : 4 (30 × 24)	75

A

AC adapter	436, 442
Accessories	436
Active D-Lighting	143, 182
Add items (My Menu)	414
ADL bracketing	143, 338

AE & flash (Auto bracketing set) 133, 338

AE only (Auto bracketing set) 133, 338

AE-L/AF-L button 97, 349, 363

AF 39–41, 87–99, 306–314

AF activation 308

AF area brackets 6, 17

AF fine-tune 380

AF-area mode 40, 90

AF-assist 313, 425, 434

AF-C 87, 306

AF-F 39

AF-mode button 39, 41, 88, 91

AF-ON button 88, 308

AF-S 39, 87, 307

After delete 287

Angle of view 74, 426–427

Aperture 120–121, 126

Aperture lock 126, 350

Aperture-priority auto 120

Approved memory cards 487

Aspect ratio 74, 391

Assign MB-D12 AF-ON 356

Assign remote (WR) Fn button ... 357

Attaching the lens 15

Auto (White balance) 148

Auto bracketing 133, 338, 339

Auto bracketing (Mode M) 339

Auto bracketing set 338

Auto distortion control 298

Auto DX crop 75

Auto FP high-speed sync. 329, 330

Auto image rotation 373

Auto ISO sensitivity control 111

Auto-area AF 91, 92

Autofocus 39–41, 87–99, 306–314

Autofocus mode 39, 87

Autofocus mode restrictions 314

B

Backlight 16, 326

Backup 86

Battery i, 13, 14, 19, 327, 328, 374, 436, 484

Battery charger i, 13, 436, 484

Battery info 374

Battery order 328

Battery pack . 104, 327, 328, 356, 436

Beep 321

BKT button .. 134, 139, 143, 188, 211, 350

Black-and-white (Monochrome) 392

Blue intensifier 393

Body cap i, 436

Border 265

Bracketing 133, 338, 339

Bracketing order 340

Built-in AF-assist Illuminator 313

Built-in flash 189, 425

Bulb 121, 123

Burst 322, 345

C

Camera Control Pro 2 441

Capture NX-D 80, 369

Center-weighted metering 114, 317

Charging the battery 13

Choose color temp. (White balance) 148, 155

Choose image area 75, 77, 348

Choose start/end point 67

CL mode shooting speed 321

Clean image sensor 445

Clock 18, 372

Clock battery 5, 203

Cloudy (White balance) 148

CLS 428

Color balance 394

Color outline 406

Color sketch	407
Color space	296
Color temperature	148, 150, 155
Commander mode	331, 334
Communication unit	437
CompactFlash	14, 366, 487
Compatible lenses	419
Compressed (Type)	81
Computer	253
Connector for external microphone 2, 441	
Continuous high speed	102
Continuous low speed	102, 321
Continuous release mode	102
Continuous-servo AF	87, 306
Control panel	5
Coordinated Universal Time (UTC) ... 234, 246	
Copy image(s)	283
Copyright information	245, 376
CPU contacts	422
CPU lens	23, 419
Creative Lighting System	428
Cropping (PictBridge [Setup] menu) 265	
Cross screen	393
Custom setting bank	304
Custom Settings	300
Customize command dials	351
Cyanotype (Monochrome)	392

D

Date and time	18, 372
Date format	18, 372
Daylight saving time	18, 372
DCF	485
Default settings	206, 272
Delete	33, 251
Delete all images	252
Delete current image	33, 251
Deleting selected photographs .	252

Depth-of-field	117
Destination (Movie settings)	63
Digital Print Order Format (DPOF) ... 266, 267, 485	
Diopter	17, 438
Direct sunlight (White balance) ..	148
Distortion control	405
D-Lighting	388
DPOF	266, 267, 485
DPOF print order	267
Dust off ref photo	369
DX (24 × 16) 1.5×	59, 75
DX format	74
DX-based (movie) format	60
Dynamic-area AF	90, 92

E

Easy exposure compensation	316
Edit movie	67, 384
Electronic front-curtain shutter ..	323
Electronic rangefinder	101
Ethernet	261, 437
EV steps for exposure cntrl	315
Exif	485
Exp./flash comp. step value	315
Exposure	114, 116, 128, 130, 133
Exposure bracketing	133, 338, 339
Exposure comp. for flash.	338
Exposure compensation	130
Exposure delay mode	322
Exposure differential	186
Exposure indicator	122
Exposure lock	128
Exposure meters	34, 319
Exposure mode	116
Exposure program	458
Exposure smoothing	218, 224
Extended menu banks	292
External microphone	62, 63, 441
Eye-Fi upload	382

F

Face-priority AF	40
File information	239
File naming	295
File number sequence	324
Filter effects	393
Fine-tune optimal exposure	318
Firmware version	383
Fisheye	406
Flash	189, 196, 198, 428
Flash (White balance)	148
Flash bracketing	133, 338, 339
Flash cntrl for built-in flash	331
Flash compensation	196
Flash mode	191
Flash only (Auto bracketing set)	133, 338
Flash pop-up button	189
Flash range	195
Flash shutter speed	193, 331
Flash sync speed	329, 330, 460
Flash sync terminal	429
Flash-ready indicator	7, 189, 199, 337, 433, 479
Flat (Set Picture Control)	170
Flexible program	118
Flicker reduction	371
Fluorescent (White balance)	148
Fn button	343, 361
f-number	120, 424
Focal length	231, 426–427
Focal plane mark	101
Focus	87–101
Focus indicator	30, 96, 101
Focus lock	96
Focus mode	39, 87, 306, 307
Focus point	29, 35, 40, 90, 94, 309, 310, 311
Focus point illumination.	309
Focus point wrap-around	310
Focus tracking	88, 308
Focus tracking with lock-on	308
Focusing screen	475
Focus-mode selector	39, 87, 100
Format	366
Format memory card	366
Frame interval (Slide show)	288
Frame rate	62, 104, 227
Frame size/frame rate	62
Framing grid	6, 325
Frequency response (Movie settings)	63
Front-curtain sync	191
Full-frame playback	235
Full-time servo AF	39
FV lock	198
FX (36 × 24) 1.0×	75
FX format	74
FX-based (movie) format	60

G

GPS	233, 246
GPS unit	233
Green intensifier	393
Group-area AF	91, 92

H

H.264	480
HDMI	269, 485
HDMI cable clip	i, 269
HDMI connector	2, 269
Headphone volume	56
Headphones	56
Help	25
Hi	110
Hide image	281
High definition	269, 485
High Dynamic Range (HDR)	184
High ISO NR	299
Highlight display	56
Highlight-weighted metering	114

Histogram241, 242, 342

I

Image area ..42, 55, 59, 60, 74, 77, 83

Image comment 375

Image Dust Off ref photo 369

Image overlay 395

Image quality 79

Image review228, 236, 287

Image size 83

Incandescent (White balance) 148

Index marking54, 361, 362, 363

Index print 266

In-focus indicator30, 96, 101

Information 238, 282

Information display201, 325, 326

Interval timer shooting 216

ISO display and adjustment 325

ISO sensitivity 109, 111

ISO sensitivity step value 315

i-TTL189, 194, 430

J

JPEG79

JPEG basic79

JPEG compression81

JPEG fine79

JPEG normal79

JPEG/TIFF Recording 295

L

L (large)60, 83

LAN 437

Landscape (Set Picture Control) 170

Language 18, 372

LCD 16, 326, 367

LCD illumination 326

Lens15, 23, 231, 380, 419

Lens distance information 194

Lens focus function buttons 359

Lens focus ring 41, 100

Lens mount 3, 15

Lens mounting mark2, 15

Limit AF-area mode selection 314

Live view 35, 49

Live view button options356

Live view photography 35

Live view selector 35, 49

Lo 110

Location data 233, 246

Lock mirror up for cleaning448

Long exposure NR299

Lossless compressed (Type) 81

M

M (Manual focus) 100

M (medium) 60, 83

Magnifying eyepiece438

Manage Picture Control177

Manual (Exposure mode) 121

Manual flash332

Manual focus41, 100

Matrix metering 114, 317

Max. continuous release322

Maximum aperture 229, 424

Maximum sensitivity 112

MB-D12 327, 328

Memory buffer 105

Memory card 14, 86, 366, 487

Memory card capacity489

Metering 114

Microphone 2, 3, 62, 63, 441

Microphone sensitivity (Movie settings) 62

Miniature effect409

Minimum aperture23, 117

Minimum shutter speed 112

Mired 154

Mirror 108, 448

Mirror up 108, 448

Mirror up mode 103, 108

Modeling flash 117, 331, 338

Monitor	31, 35, 201, 235, 367
Monitor brightness	56, 367
Monitor color balance	368
Monitor cover	10
Monitor off delay	320
Monitor pre-flash	194, 331
Monochrome	392
Monochrome (Set Picture Control) ..	170
Movie ISO sensitivity settings (Movie settings)	64
Movie live view	49, 361
Movie quality (Movie settings)	62
Movie settings	62
Movie-record button	52
Movies	49
Multi selector	11, 25, 343
Multiple exposure	209
Multi-selector center button	341
My Menu	414

N

NEF (RAW)	79, 80, 81, 82, 85, 295, 399
NEF (RAW) bit depth	82
NEF (RAW) processing	399
NEF (RAW) recording	81, 85, 295
Neutral (Set Picture Control)	170
Nikon Transfer 2	258
No. of copies (PictBridge [Setup] menu)	265
Non-CPU lens	229, 420, 424
Normal-area AF	40
Number of focus points	311

O

Optimal quality (JPEG compression) 81	
Optional flash	428
Overflow	86
Overview data	247

P

Page size	265
Perspective control	408
Photo info	238, 282
Photo live view display WB	43
PictBridge	263, 485
Picture Control Utility	180
Picture Controls	170
Picture size	426
Playback	31, 235
Playback display options	282
Playback folder	281
Playback information	238, 282
Playback menu	280
Playback zoom	248
Portrait (Set Picture Control)	170
Power aperture	361, 362
Power connector	436, 442
Predictive focus tracking	88
Preset focus point	342, 359
Preset manual (White balance) ..	148, 158
Press the shutter-release button halfway	30, 128
Primary slot	86
Print (DPOF)	266
Print options (PictBridge [Setup] menu)	265
Print select	266
Printing	263
Programmed auto	118
Protecting photographs	250
Pv button	54, 117, 349, 362

Q

Quick retouch	404
---------------------	-----

R

Rank items (My Menu)	417
Rear-curtain sync	192

Recent settings	418	Shutter-release button ...	30, 96, 128, 319, 364
Red intensifier	393	Shutter-release button AE-L	319
Red-eye correction	389	Side-by-side comparison	412
Red-eye reduction	191	Single frame	102
Release button to use dial	353	Single-point AF	90, 92
Release mode	102	Single-servo AF	39, 87, 307
Remote cord	123, 439, 440	Size	60, 83, 391
Remove items (My Menu)	416	Size priority (JPEG compression) ..	81
Removing the lens from the camera		Skylight	393
23		Slide show	288
Repeating flash	331	Slot empty release lock	353
Reset	206	Slot selection	168, 237, 385
Resize	401	Slow sync	191
Restoring default settings ...	206, 272	Smoothing	186
Retouch menu	384	Soft	394
Reverse indicators	354	Speedlights	189, 428
RGB	79, 241, 296	Split-screen display zoom	43, 44
RGB Histogram	241	Spot	114
Rotate tall	288	Spot white balance	163
S		Standard (Set Picture Control)	170
S (small)	60, 83	Standard i-TTL flash for digital SLR ...	194, 430
Save selected frame	67	Standby timer	34, 234, 319
Save/load settings	377	Start printing	265, 266
Screen tips	325	Storage folder	293
SD memory card	14, 366, 487	Store by orientation	312
Secondary slot function	86	Straighten	404
Selective color	410	Sub-dial frame advance	352
Self-timer	103, 106, 319	T	
Sensitivity	109, 111	Television	269
Sepia (Monochrome)	392	Ten-pin remote terminal 3, 233, 439,	440
Set clock from satellite	234	Thumbnail	235, 342
Set Picture Control	170	TIFF (RGB)	79
Setup menu	365	Time	123
Shade (White balance)	148	Time stamp (PictBridge)	265
Shooting data	243	Time zone	18, 372
Shooting menu	290	Time zone and date	18, 372
Shooting menu bank	291	Time-lapse photography	223
Shutter speed	119, 121, 126		
Shutter speed lock	126, 350		
Shutter-priority auto	119		

Timer	106, 216
Trim	390
Tripod	40, 106, 123
Two-button reset	206
Type D lens	419, 422
Type G lens	419, 422

U

Uncompressed (Type)	81
USB	257, 263
USB cable	i, 257, 263
USB cable clip	i, 258
UT-1	437
UTC	234, 246

V

Viewfinder	6, 17, 475
Viewfinder eyepiece	23, 106
Viewfinder focus	17, 438
Viewfinder grid display	325
Viewing photographs on TV	269
ViewNX 2	80, 253, 373, 376
Vignette control	297
Virtual horizon	46, 58, 347, 379
Vivid (Set Picture Control)	170

W

Warm filter	393
WB	139, 148
WB bracketing (Auto bracketing set) 139, 338	
White balance	139, 148
White balance bracketing ...	139, 338
Wide-area AF	40
Wind noise reduction (Movie settings)	63
Wireless network	261, 437
Wireless remote controller ..	61, 357, 441
Wireless transmitter	261, 437
WT-5	261, 437

No reproduction in any form of this manual, in whole or in part (except for brief quotation in critical articles or reviews), may be made without written authorization from NIKON CORPORATION.

NIKON CORPORATION

© 2014 Nikon Corporation



SB4G01(11)
6MB25311-01