

**FUJIFILM**

DIGITAL CAMERA

# **X-Pro3**

Owner's Manual

## Introduction

Thank you for your purchase of this product. Be sure that you have read this manual and understood its contents before using the camera. Keep the manual where it will be read by all who use the product.

### For the Latest Information

The latest versions of the manuals are available from:

*<http://fujifilm-dsc.com/en/manual/>*



The site can be accessed not only from your computer but also from smartphones and tablets. It also contains information on the software license.



For information on firmware updates, visit:

*[http://www.fujifilm.com/support/digital\\_cameras/software/](http://www.fujifilm.com/support/digital_cameras/software/)*



## Chapter Index

---

<b>Menu List</b>	iv
<b>1 Before You Begin</b>	1
<b>2 First Steps</b>	27
<b>3 Basic Photography and Playback</b>	43
<b>4 Movie Recording and Playback</b>	49
<b>5 Taking Photographs</b>	57
<b>6 The Shooting Menus</b>	97
<b>7 Playback and the Playback Menu</b>	167
<b>8 The Setup Menus</b>	193
<b>9 Shortcuts</b>	239
<b>10 Peripherals and Optional Accessories</b>	251
<b>11 Connections</b>	269
<b>12 Technical Notes</b>	285







## Menu List























Camera menu options are listed below.

### Shooting Menus

Adjust settings when shooting photos or movies.

 See page 97 for details.





 IMAGE QUALITY SETTING		 AF/MF SETTING	
<b>IMAGE SIZE</b>	: 98	<b>FOCUS AREA</b>	: 114
<b>IMAGE QUALITY</b>	: 99	<b>AF MODE</b>	: 115
<b>RAW RECORDING</b>	: 100	<b>AF-C CUSTOM SETTINGS</b>	: 116
<b>FILM SIMULATION</b>	: 100	<b>STORE AF MODE BY ORIENTATION</b>	: 120
<b>MONOCHROMATIC COLOR</b>	: 102	<b>AF POINT DISPLAY</b>  	: 120
<b>GRAIN EFFECT</b>	: 102	<b>NUMBER OF FOCUS POINTS</b>	: 120
<b>COLOR CHROME EFFECT</b>	: 103	<b>PRE-AF</b>	: 121
<b>COLOR CHROME FX BLUE</b>	: 103	<b>AF ILLUMINATOR</b>	: 121
<b>WHITE BALANCE</b>	: 104	<b>FACE/EYE DETECTION SETTING</b>	: 122
<b>DYNAMIC RANGE</b>	: 107	<b>AF+MF</b>	: 124
<b>D RANGE PRIORITY</b>	: 108	<b>MF ASSIST</b>	: 125
<b>TONE CURVE</b>	: 108	<b>FOCUS CHECK</b>	: 125
<b>COLOR</b>	: 109	<b>INTERLOCK SPOT AE &amp; FOCUS AREA</b>	: 126
<b>SHARPNESS</b>	: 109	<b>INSTANT AF SETTING</b>	: 126
<b>NOISE REDUCTION</b>	: 109	<b>DEPTH-OF-FIELD SCALE</b>	: 126
<b>CLARITY</b>	: 110	<b>RELEASE/FOCUS PRIORITY</b>	: 127
<b>LONG EXPOSURE NR</b>	: 110	<b>AF RANGE LIMITER</b>	: 127
<b>LENS MODULATION OPTIMIZER</b>	: 110	<b>TOUCH SCREEN MODE</b>	: 128
<b>COLOR SPACE</b>	: 110	<b>CORRECTED AF FRAME</b>	: 131
<b>PIXEL MAPPING</b>	: 111		
<b>SELECT CUSTOM SETTING</b>	: 111		
<b>EDIT/SAVE CUSTOM SETTING</b>	: 112		

	<b>SHOOTING SETTING</b>	
	SPORTS FINDER MODE	132
	PRE-SHOT ES 	133
	SELF-TIMER	134
	SAVE SELF-TIMER SETTING	134
1/3	INTERVAL TIMER SHOOTING	135
	INTERVAL TIMER SHOOTING EXPOSURE SMOOTHING	136
	AE BKT SETTING	137
	FILM SIMULATION BKT	137
	FOCUS BKT SETTING	138
	MULTIPLE EXPOSURE CTRL	140
	PHOTOMETRY	141
2/3	SHUTTER TYPE	142
	FLICKER REDUCTION	143
	IS MODE	144
	ISO AUTO SETTING	145
	MOUNT ADAPTER SETTING	146
3/3	WIRELESS COMMUNICATION	148
	<b>FLASH SETTING</b>	
	FLASH FUNCTION SETTING	149
	RED EYE REMOVAL	149
	TTL-LOCK MODE	150
	LED LIGHT SETTING	150
	MASTER SETTING	151
	CH SETTING	151
	<b>MOVIE SETTING</b>	
	MOVIE MODE	152
	FULL HD HIGH SPEED REC	153
	 FILM SIMULATION	154
	 MONOCHROMATIC COLOR	154
1/4	 WHITE BALANCE	155
	 DYNAMIC RANGE	155
	 TONE CURVE	156
	 COLOR	156
	 SHARPNESS	156
	 NOISE REDUCTION	157
	 INTERFRAME NR	157
2/4	F-Log RECORDING	158
	 PERIPHERAL LIGHT CORRECTION	158
	 FOCUS AREA	158
	MOVIE AF MODE	159
	 AF-C CUSTOM SETTING	159
	 FACE/EYE DETECTION SETTING	160
	 MF ASSIST	160
	 FOCUS CHECK	160
3/4	ZEBRA SETTING	161
	ZEBRA LEVEL	161
	AUDIO SETTING	161
	MIC/REMOTE RELEASE	163
	TIME CODE SETTING	163
4/4	TALLY LIGHT	165
	MOVIE SILENT CONTROL	166

## The Playback Menu

Adjust playback settings.





 See page 173 for details.

 <b>PLAY BACK MENU</b>		 <b>PLAY BACK MENU</b>	
<b>SWITCH SLOT</b>	:173	<b>RED EYE REMOVAL</b>	:182
<b>RAW CONVERSION</b>	:174	<b>VOICE MEMO SETTING</b>	:183
<b>ERASE</b>	:176	<b>RATING</b>	:184
<b>SIMULTANEOUS DELETE</b> <b>(RAW SLOT1/JPG SLOT2)</b>	:178	<b>2<math>\frac{1}{3}</math> COPY</b>	:185
<b>1<math>\frac{1}{3}</math> CROP</b>	:178	<b>2<math>\frac{1}{3}</math> IMAGE TRANSFER ORDER</b>	:186
<b>RESIZE</b>	:179	<b>WIRELESS COMMUNICATION</b>	:187
<b>PROTECT</b>	:180	<b>SLIDE SHOW</b>	:187
<b>IMAGE ROTATE</b>	:181	<b>PHOTOBOOK ASSIST</b>	:188
		<b>PC AUTO SAVE</b>	:189
		<b>3<math>\frac{1}{3}</math> PRINT ORDER (DPOF)</b>	:190
		<b>instax PRINTER PRINT</b>	:191

## Setup Menu

Adjust basic camera settings.

 See page 193 for details.

<b>USER SETTING</b>		<b>SCREEN SETTING</b>	
FORMAT	194	EYE SENSOR SETTING	201
DATE/TIME	195	EVF BRIGHTNESS	201
TIME DIFFERENCE	195	EVF COLOR	201
 言語/LANG.	196	EVF COLOR ADJUSTMENT	202
MY MENU SETTING	196	LCD BRIGHTNESS	202
SENSOR CLEANING	197	LCD COLOR	202
RESET	198	LCD COLOR ADJUSTMENT	202
REGULATORY	198	IMAGE DISP.	203
<b>SOUND SETTING</b>		AUTOROTATE DISPLAYS	203
AF BEEP VOL.	199	PREVIEW EXP./WB IN MANUAL MODE	204
SELF-TIMER BEEP VOL.	199	NATURAL LIVE VIEW	204
OPERATION VOL.	200	FRAMING GUIDELINE	205
SHUTTER VOLUME	200	AUTOROTATE PB	206
SHUTTER SOUND	200	FOCUS SCALE UNITS	206
PLAYBACK VOLUME	200	APERTURE UNIT FOR CINEMA LENS	207
		OVF, IMAGE DISP.	207
		DISP. CUSTOM SETTING	208
		LARGE INDICATORS MODE(EVF/OVF)	210
		LARGE INDICATORS MODE(LCD)	210
		LARGE INDICATORS DISP. SETTING	211
		INFORMATION CONTRAST ADJ.	211
		SUB MONITOR	212

1/3	<b>FUNCTION/DIAL SETTING</b>		<b>SAVE DATA SETTING</b>	
	FOCUS LEVER SETTING	:214	FRAME NO.	:227
	EDIT/SAVE QUICK MENU	:215	SAVE ORG IMAGE	:228
	Q MENU BACKGROUND	:216	EDIT FILE NAME	:228
	FUNCTION (Fn) SETTING	:216	CARD SLOT SETTING (STILL IMAGE)	:228
	COMMAND DIAL SETTING	:219	SELECT SLOT(  SEQUENTIAL)	:229
	SHUTTER AF	:220	SELECT SLOT(  SEQUENTIAL)	:229
	SHUTTER AE	:220	SELECT FOLDER	:229
	SHOOT WITHOUT LENS	:221	COPYRIGHT INFO	:230
	SHOOT WITHOUT CARD	:221		
2/3	FOCUS RING	:221	<b>CONNECTION SETTING</b>	
	FOCUS RING OPERATION	:222	Bluetooth SETTINGS	:231
	AE/AF-LOCK MODE	:222	NETWORK SETTING	:233
	AWB-LOCK MODE	:222	PC AUTO SAVE	:233
	APERTURE RING SETTING (A)	:223	instax PRINTER CONNECTION	
	APERTURE SETTING	:223	1/2 SETTING	:234
3/3	TOUCH SCREEN SETTING	:224	PC CONNECTION MODE	:235
	LOCK	:224	USB POWER SUPPLY SETTING	:236
	<b>POWER MANAGEMENT</b>		GENERAL SETTINGS	:237
	AUTO POWER OFF	:225	INFORMATION	:237
	PERFORMANCE	:226	2/2 RESET WIRELESS SETTING	:237
	EVF PERFORMANCE	:226		





# Table of Contents

Introduction.....	ii
For the Latest Information.....	ii
Menu List.....	iv
Shooting Menus.....	iv
The Playback Menu.....	vi
Setup Menus.....	vii
Supplied Accessories.....	xix
About This Manual.....	xx
Symbols and Conventions.....	xx
Terminology.....	xx

## **1 Before You Begin** **1**



Parts of the Camera.....	2
The Viewfinder Window.....	4
The LCD Monitor and Sub Monitor.....	6
The Focus Stick (Focus Lever).....	7
The Shutter Speed Dial/Sensitivity Dial.....	7
The Exposure Compensation Dial.....	8
Focusing the Viewfinder.....	8
The DRIVE Button.....	8
The Command Dials.....	9
The Indicator Lamp.....	10
Camera Displays.....	11
The Sub Monitor.....	11
The Optical Viewfinder.....	12
The EVF/LCD Monitor.....	14
Adjusting Display Brightness.....	16
Display Rotation.....	16
Bright Frame Simulation.....	16
The DISP/BACK Button.....	17
Customizing the Standard Display.....	19
Using the Menus.....	21
Touch Screen Mode.....	22
Shooting Touch Controls.....	22
Playback Touch Controls.....	26















<b>2</b>	<b>First Steps</b>	<b>27</b>
	Attaching the Strap .....	28
	Attaching a Lens.....	30
	Inserting the Battery.....	31
	Inserting Memory Cards.....	33
	Using Two Cards.....	34
	Compatible Memory Cards .....	35
	Charging the Battery .....	36
	Turning the Camera On and Off .....	38
	Checking the Battery Level.....	39
	Basic Setup .....	40
	Choosing a Different Language.....	42
	Changing the Time and Date.....	42
<b>3</b>	<b>Basic Photography and Playback</b>	<b>43</b>
	Taking Photographs (Mode P).....	44
	Viewing Pictures.....	47
	Deleting Pictures.....	48
<b>4</b>	<b>Movie Recording and Playback</b>	<b>49</b>
	Recording Movies .....	50
	Adjusting Movie Settings.....	52
	Viewing Movies.....	54
<b>5</b>	<b>Taking Photographs</b>	<b>57</b>
	P, S, A, and M Modes.....	58
	Mode P: Program AE .....	58
	Mode S: Shutter-Priority AE .....	60
	Mode A: Aperture-Priority AE.....	64
	Mode M: Manual Exposure .....	65
	Autofocus.....	67
	Focus Mode.....	68
	Autofocus Options (AF Mode).....	70
	Focus-Point Selection.....	72
	Manual Focus.....	75
	Checking Focus.....	77
	Sensitivity.....	79
	Auto Sensitivity (A).....	80
	Metering.....	81

Exposure Compensation .....	82
C (Custom) .....	83
Focus/Exposure Lock .....	84
Other Controls .....	85
Bracketing.....	86
<b>ISO</b> ISO BKT.....	86
<b>WB</b> WHITE BALANCE BKT.....	86
<b>BKT</b> BKT.....	87
Continuous Shooting (Burst Mode) .....	90
HDR .....	91
Multiple Exposures.....	93
Advanced Filters.....	95
Advanced Filter Options.....	96

## **6 The Shooting Menus** **97**

IMAGE QUALITY SETTING.....	98
IMAGE SIZE.....	98
IMAGE QUALITY .....	99
RAW RECORDING .....	100
FILM SIMULATION.....	100
MONOCHROMATIC COLOR.....	102
GRAIN EFFECT .....	102
COLOR CHROME EFFECT.....	103
COLOR CHROME FX BLUE.....	103
WHITE BALANCE.....	104
DYNAMIC RANGE.....	107
D RANGE PRIORITY.....	108
TONE CURVE .....	108
COLOR.....	109
SHARPNESS.....	109
NOISE REDUCTION.....	109
CLARITY.....	110
LONG EXPOSURE NR.....	110
LENS MODULATION OPTIMIZER.....	110
COLOR SPACE .....	110
PIXEL MAPPING.....	111
SELECT CUSTOM SETTING.....	111
EDIT/SAVE CUSTOM SETTING.....	112

<b>AF/MF SETTING</b> .....	<b>114</b>
FOCUS AREA .....	114
AF MODE.....	115
AF-C CUSTOM SETTINGS.....	116
STORE AF MODE BY ORIENTATION.....	120
AF POINT DISPLAY   .....	120
NUMBER OF FOCUS POINTS .....	120
PRE-AF .....	121
AF ILLUMINATOR .....	121
FACE/EYE DETECTION SETTING .....	122
AF+MF .....	124
MF ASSIST .....	125
FOCUS CHECK.....	125
INTERLOCK SPOT AE & FOCUS AREA.....	126
INSTANT AF SETTING .....	126
DEPTH-OF-FIELD SCALE.....	126
RELEASE/FOCUS PRIORITY .....	127
AF RANGE LIMITER .....	127
TOUCH SCREEN MODE.....	128
CORRECTED AF FRAME .....	131
<b>SHOOTING SETTING</b> .....	<b>132</b>
SPORTS FINDER MODE.....	132
PRE-SHOT  .....	133
SELF-TIMER.....	134
SAVE SELF-TIMER SETTING.....	134
INTERVAL TIMER SHOOTING.....	135
INTERVAL TIMER SHOOTING EXPOSURE SMOOTHING .....	136
AE BKT SETTING .....	137
FILM SIMULATION BKT .....	137
FOCUS BKT SETTING .....	138
MULTIPLE EXPOSURE CTRL .....	140
PHOTOMETRY.....	141
SHUTTER TYPE .....	142
FLICKER REDUCTION.....	143
IS MODE .....	144
ISO AUTO SETTING.....	145
MOUNT ADAPTER SETTING .....	146
WIRELESS COMMUNICATION .....	148

<b>FLASH SETTING</b> .....	<b>149</b>
FLASH FUNCTION SETTING.....	149
RED EYE REMOVAL.....	149
TTL-LOCK MODE.....	150
LED LIGHT SETTING.....	150
MASTER SETTING.....	151
CH SETTING.....	151
<b>MOVIE SETTING</b> .....	<b>152</b>
MOVIE MODE.....	152
FULL HD HIGH SPEED REC.....	153
 FILM SIMULATION.....	154
 MONOCHROMATIC COLOR.....	154
 WHITE BALANCE.....	155
 DYNAMIC RANGE.....	155
 TONE CURVE.....	156
 COLOR.....	156
 SHARPNESS.....	156
 NOISE REDUCTION.....	157
 INTERFRAME NR.....	157
F-Log RECORDING.....	158
 PERIPHERAL LIGHT CORRECTION.....	158
 FOCUS AREA.....	158
MOVIE AF MODE.....	159
 AF-C CUSTOM SETTING.....	159
 FACE/EYE DETECTION SETTING.....	160
 MF ASSIST.....	160
 FOCUS CHECK.....	160
ZEBRA SETTING.....	161
ZEBRA LEVEL.....	161
AUDIO SETTING.....	161
MIC/REMOTE RELEASE.....	163
TIME CODE SETTING.....	163
TALLY LIGHT.....	165
MOVIE SILENT CONTROL.....	166



## **7 Playback and the Playback Menu 167**

The Playback Display .....	168
The DISP/BACK Button .....	169
Viewing Pictures .....	171
Playback Zoom .....	172
Multi-Frame Playback .....	172
The Playback Menu .....	173
SWITCH SLOT .....	173
RAW CONVERSION .....	174
ERASE .....	176
SIMULTANEOUS DELETE(RAW SLOT1/JPG SLOT2) .....	178
CROP .....	178
RESIZE .....	179
PROTECT .....	180
IMAGE ROTATE .....	181
RED EYE REMOVAL .....	182
VOICE MEMO SETTING .....	183
RATING .....	184
COPY .....	185
IMAGE TRANSFER ORDER .....	186
WIRELESS COMMUNICATION .....	187
SLIDE SHOW .....	187
PHOTOBOOK ASSIST .....	188
PC AUTO SAVE .....	189
PRINT ORDER (DPOF) .....	190
instax PRINTER PRINT .....	191

## **8 The Setup Menus 193**

USER SETTING .....	194
FORMAT .....	194
DATE/TIME .....	195
TIME DIFFERENCE .....	195
🗣️ 言語/LANG .....	196
MY MENU SETTING .....	196
SENSOR CLEANING .....	197
RESET .....	198
REGULATORY .....	198

<b>SOUND SETTING</b> .....	<b>199</b>
AF BEEP VOL.....	199
SELF-TIMER BEEP VOL.....	199
OPERATION VOL.....	200
SHUTTER VOLUME.....	200
SHUTTER SOUND.....	200
PLAYBACK VOLUME.....	200
<b>SCREEN SETTING</b> .....	<b>201</b>
EYE SENSOR SETTING.....	201
EVF BRIGHTNESS.....	201
EVF COLOR.....	201
EVF COLOR ADJUSTMENT.....	202
LCD BRIGHTNESS.....	202
LCD COLOR.....	202
LCD COLOR ADJUSTMENT.....	202
IMAGE DISP.....	203
AUTOROTATE DISPLAYS.....	203
PREVIEW EXP/WB IN MANUAL MODE.....	204
NATURAL LIVE VIEW.....	204
FRAMING GUIDELINE.....	205
AUTOROTATE PB.....	206
FOCUS SCALE UNITS.....	206
APERTURE UNIT FOR CINEMA LENS.....	207
OVF, IMAGE DISP.....	207
DISP. CUSTOM SETTING.....	208
LARGE INDICATORS MODE(EVF/OVF).....	210
LARGE INDICATORS MODE(LCD).....	210
LARGE INDICATORS DISP. SETTING.....	211
INFORMATION CONTRAST ADJ.....	211
SUB MONITOR.....	212
<b>BUTTON/DIAL SETTING</b> .....	<b>214</b>
FOCUS LEVER SETTING.....	214
EDIT/SAVE QUICK MENU.....	215
Q MENU BACKGROUND.....	216
FUNCTION (Fn) SETTING.....	216
COMMAND DIAL SETTING.....	219
SHUTTER AF.....	220
SHUTTER AE.....	220

SHOOT WITHOUT LENS .....	221
SHOOT WITHOUT CARD .....	221
FOCUS RING .....	221
FOCUS RING OPERATION .....	222
AE/AF-LOCK MODE .....	222
AWB-LOCK MODE .....	222
APERTURE RING SETTING (A) .....	223
APERTURE SETTING .....	223
TOUCH SCREEN SETTING .....	224
LOCK .....	224
<b>POWER MANAGEMENT .....</b>	<b>225</b>
AUTO POWER OFF .....	225
PERFORMANCE .....	226
EVF PERFORMANCE .....	226
<b>SAVE DATA SETTING .....</b>	<b>227</b>
FRAME NO. ....	227
SAVE ORG IMAGE .....	228
EDIT FILE NAME .....	228
CARD SLOT SETTING (STILL IMAGE) .....	228
SELECT SLOT(  SEQUENTIAL) .....	229
SELECT SLOT(  SEQUENTIAL) .....	229
SELECT FOLDER .....	229
COPYRIGHT INFO .....	230
<b>CONNECTION SETTING .....</b>	<b>231</b>
Bluetooth SETTINGS .....	231
NETWORK SETTING .....	233
PC AUTO SAVE .....	233
instax PRINTER CONNECTION SETTING .....	234
PC CONNECTION MODE .....	235
USB POWER SUPPLY SETTING .....	236
GENERAL SETTINGS .....	237
INFORMATION .....	237
RESET WIRELESS SETTING .....	237



<b>9</b>	<b>Shortcuts</b>	<b>239</b>
	Shortcut Options.....	240
	MY MENU .....	241
	MY MENU SETTING .....	241
	The Q (Quick Menu) Button.....	243
	The Quick Menu Display .....	243
	Viewing and Changing Settings.....	244
	Editing the Quick Menu.....	245
	The Fn (Function) Buttons .....	246
	Assigning Roles to the Function Buttons.....	248
<b>10</b>	<b>Peripherals and Optional Accessories</b>	<b>251</b>
	Lenses.....	252
	Lens Parts.....	252
	Removing Lens Caps .....	253
	Attaching Lens Hoods .....	253
	Lenses with Aperture Rings.....	254
	Lenses with No Aperture Rings.....	255
	Lenses with O.I.S. Switches.....	255
	Manual Focus Lenses.....	256
	Lens Care.....	257
	External Flash Units.....	258
	Flash Settings .....	259
	SYNC TERMINAL.....	260
	SHOE MOUNT FLASH .....	261
	MASTER(OPTICAL) .....	264
<b>11</b>	<b>Connections</b>	<b>269</b>
	Wireless Connections	
	(Bluetooth®, Wireless LAN/Wi-Fi).....	270
	Smartphones and Tablets: FUJIFILM Camera Remote.....	270
	Tethered Shooting: Capture One Pro Fujifilm/Adobe® Photoshop® Lightroom® Classic CC + FUJIFILM Tether Shooting Plug-in/ FUJIFILM X Acquire.....	272

<b>Connecting via USB</b> .....	<b>273</b>
Connecting to Computers.....	273
Tethered Shooting: Capture One Pro Fujifilm/Adobe® Photoshop® Lightroom® Classic CC + FUJIFILM Tether Shooting Plug-in/ FUJIFILM X Acquire.....	276
Copying Pictures to a Computer.....	277
Converting RAW Images: FUJIFILM X RAW STUDIO .....	278
Backing up and Restoring Camera Settings (FUJIFILM X Acquire).....	278
Connecting to Smartphones.....	279
<b>instax SHARE Printers</b> .....	<b>282</b>
Establishing a Connection .....	282
Printing Pictures.....	283

## **12 Technical Notes** **285**

<b>Accessories from Fujifilm</b> .....	<b>286</b>
<b>Software for Use with Your Camera</b> .....	<b>289</b>
FUJIFILM Camera Remote .....	289
Capture One Express Fujifilm .....	289
RAW FILE CONVERTER EX.....	289
Capture One Pro Fujifilm .....	289
Adobe® Photoshop® Lightroom® Classic CC + FUJIFILM Tether Shooting Plug-in.....	290
FUJIFILM X Acquire .....	290
FUJIFILM X RAW STUDIO .....	290
<b>For Your Safety</b> .....	<b>291</b>
<b>Product Care</b> .....	<b>300</b>
<b>Cleaning the Image Sensor</b> .....	<b>301</b>
<b>Firmware Updates</b> .....	<b>302</b>
Checking the Firmware Version.....	302
<b>Troubleshooting</b> .....	<b>303</b>
<b>Warning Messages and Displays</b> .....	<b>312</b>
<b>Memory Card Capacity</b> .....	<b>316</b>
<b>Specifications</b> .....	<b>317</b>

## Supplied Accessories

---

The following are included with the camera:

- NP-W126S rechargeable battery
- USB cable
- Body cap (comes attached to camera)
- Metal strap clips (× 2)
- Clip attaching tool
- Protective covers (× 2)
- Shoulder strap
- Hot shoe cover (comes attached to hot shoe)
- Cleaning cloth
- *Owner's Manual* (this manual)





For information on compatible computer software, see “Software for Use with Your Camera” (📖 289).

## About This Manual

This manual contains instructions for your FUJIFILM X-Pro3 digital camera. Be sure you have read and understood its contents before proceeding.

### Symbols and Conventions

The following symbols are used in this manual:

-  Information that should be read to prevent damage to the product.
-  Additional information that may be helpful when using the product.
-  Pages on which related information may be found.

Menus and other text in the displays are shown in **bold**. Illustrations are for explanatory purposes only; drawings may be simplified, while photographs are not necessarily taken with the model of camera described in this manual.

### Terminology

The optional SD, SDHC, and SDXC memory cards the camera uses to store pictures are referred to as “memory cards”. The electronic viewfinder may be referred to as the “EVF” and the LCD monitor as the “LCD”.

# Before You Begin



## Parts of the Camera

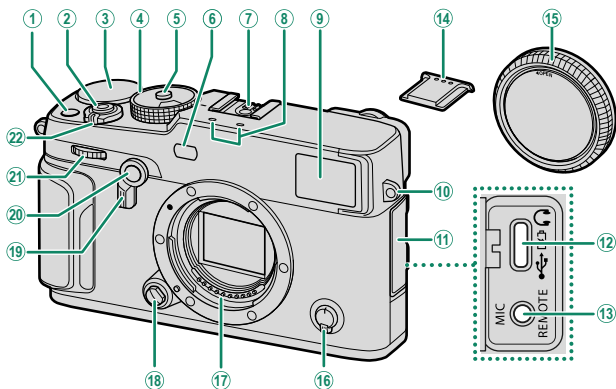

① <b>Fn1</b> button.....	81	⑫ USB connector (Type-C).....	36, 54, 273
② Shutter button.....	45	⑬ Microphone/remote release connector (ø2.5 mm).....	51, 63
③ Exposure compensation dial.....	8, 82	⑭ Hot shoe cover.....	259
④ Shutter speed dial/ Sensitivity dial.....	7, 79, 145	⑮ Body cap.....	30
⑤ Dial lock release.....	7	⑯ Focus mode selector.....	68
⑥ AF-assist illuminator.....	121	⑰ Lens signal contacts	
Self-timer lamp.....	133	⑱ Lens release button.....	30
⑦ Hot shoe.....	259	⑲ Viewfinder selector.....	4, 16
⑧ Microphone.....	51, 161	⑳ <b>Fn2</b> button.....	183, 246
⑨ Viewfinder window.....	4, 6, 12, 17	㉑ Front command dial.....	9, 219
⑩ Strap eyelet.....	28	㉒ <b>ON/OFF</b> switch.....	38
⑪ Connector cover			

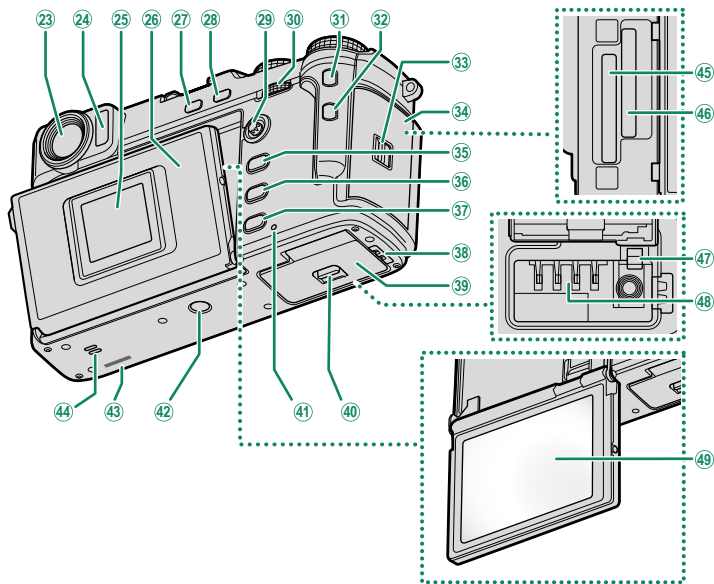

- |    |  |    |   |
|----|--|----|---|
| 23 | Viewfinder window.....4, 6, 12, 17   | 36 | <b>PLAY</b> (playback) button .....47                         |
| 24 | Eye sensor.....6   | 37 | <b>DISP</b> (display)/ <b>BACK</b> button..... 17, 169        |
| 25 | Sub monitor .....6, 11, 212  | 38 | Cable channel cover for DC coupler..... 286                   |
| 26 | Monitor panel  | 39 | Battery-chamber cover.....31                                  |
| 27 | <b>DRIVE</b> button/ <b>DELETE</b> (delete) button<br>.....8, 44, 48, 86     | 40 | Battery-chamber cover latch.....31                            |
| 28 | <b>AE-L</b> (exposure lock)/<br><b>AF-L</b> (focus lock) button..... 85, 246 | 41 | Indicator lamp..... 10, 165                                   |
| 29 | Focus stick (focus lever).....7, 72, 214                                     | 42 | Tripod mount  |
| 30 | Rear command dial.....9, 171, 219  | 43 | Serial number   |
| 31 | <b>Fn3</b> button .....246   | 44 | Speaker ..... 54, 200   |
| 32 | <b>Q</b> (quick menu) button.....243   | 45 | Memory card slot 1 .....33                                    |
| 33 | Memory card slot cover latch.....33  | 46 | Memory card slot 2 .....33                                    |
| 34 | Memory card slot cover .....33   | 47 | Battery latch.....32  |
| 35 | <b>MENU/OK</b> button.....21   | 48 | Battery chamber.....31  |
|    |  | 49 | LCD monitor ..... 6, 12, 16<br>Touch screen .....22, 128, 224 |

## The Viewfinder Window

Use the viewfinder selector to switch between the electronic viewfinder (EVF) and the optical viewfinder (OVF). In addition, a small electronic rangefinder (ERF) window can be displayed in the OVF.

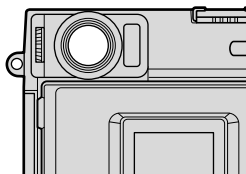

## Switching Between the EVF and OVF

To switch between the EVF and OVF, pull the viewfinder selector to the right.

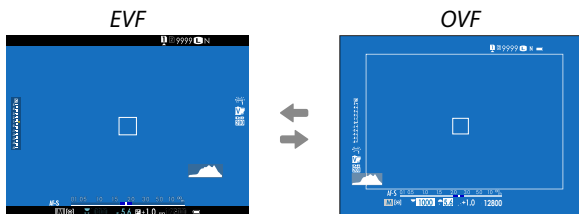
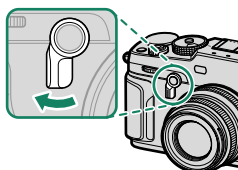

 The camera automatically switches from the OVF to the EVF during movie recording.



## Turning the ERF On and Off

To turn the ERF on or off, pull the viewfinder selector to the left while the OVF is displayed.

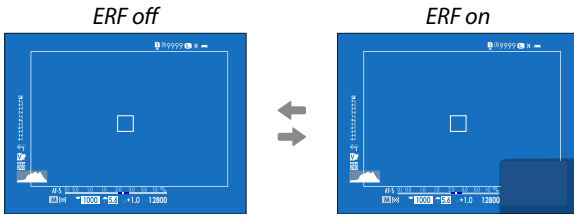
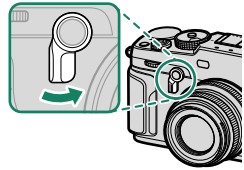

The ERF is available only when  **SINGLE POINT** is selected for AF mode.

### The Hybrid (EVF/OVF/ERF) Viewfinder

The features of the different displays are described below.

Display	Description
<b>OVF</b>	<ul style="list-style-type: none"> <li>The optical display shows the subject clearly. The subject is in sharp focus so that their expression is always visible.</li> <li>The OVF shows the area just outside the frame, making it easier to compose shots.</li> <li>Because the viewfinder window is a slight distance from the lens, the area visible in photographs may however differ slightly from the display in the viewfinder due to parallax.</li> </ul>
<b>EVF</b>	<ul style="list-style-type: none"> <li>The EVF offers 100% frame coverage for increased accuracy when composing shots.</li> <li>It can be used to preview depth of field, focus, exposure, and white balance.</li> </ul>
<b>ERF</b>	As for the optical viewfinder but with a focus preview window.

## The LCD Monitor and Sub Monitor

Shooting settings are displayed in the sub monitor when the monitor panel is closed. Opening the panel turns the main monitor (LCD) on and the viewfinder (EVF) off.

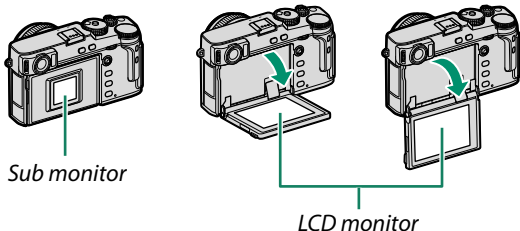

- ❗ When using the monitor panel, be careful that it does not catch your fingers or other objects.
- Do not touch the wires behind the monitor panel. Failure to observe this precaution could cause product malfunction.

📱 The LCD monitor also functions as a touch screen that can be used for:

- Touch photography (📖 23)
- Function selection (📖 25)
- Muting camera controls during movie recording (📖 24)
- Full-frame playback (📖 26)

### The Eye Sensor

- The eye sensor controls the LCD monitor when the monitor panel is open, turning the LCD monitor off and the EVF on as required.
- The eye sensor may respond to objects other than your eye or to light shining directly on the sensor.
- The eye sensor can be disabled using **SCREEN SET-UP > EYE SENSOR SETTING**.

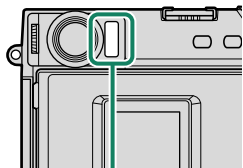

Eye sensor

## The Focus Stick (Focus Lever)

Tilt or press the focus stick to select the focus area. The focus stick can also be used to navigate the menus.

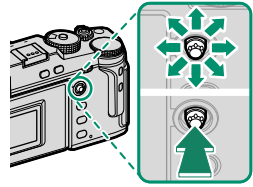

## The Shutter Speed Dial/Sensitivity Dial

Shutter speed can be adjusted by rotating the shutter speed dial/sensitivity dial. Lift and rotate the dial to adjust sensitivity.

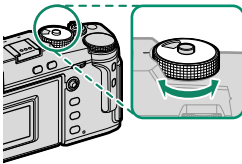

*Shutter speed*

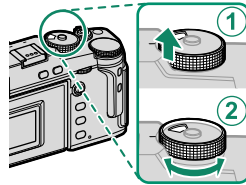

*Sensitivity*

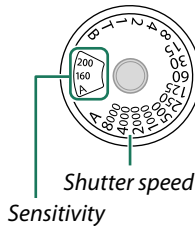

**!** To choose another shutter speed after selecting **A** (auto), hold the dial lock release and rotate the shutter speed dial.

## The Exposure Compensation Dial

Rotate the dial to choose an exposure compensation amount.

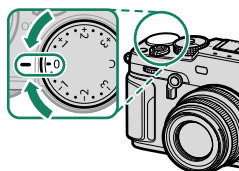

## Focusing the Viewfinder

Viewfinder focus can be adjusted by rotating the diopter adjustment control.

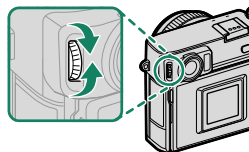

## The DRIVE Button

Pressing the **DRIVE** button displays the drive-mode menu.

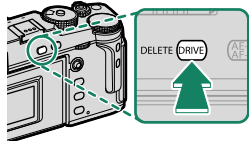



Mode	
STILL IMAGE	44
CONTINUOUS	90
CONTINUOUS	
ISO BKT	86
WHITE BALANCE BKT	86

Mode	
BKT	87
HDR	91
MULTIPLE EXPOSURE	93
ADVANCED FILTER	95
MOVIE	50

## The Command Dials

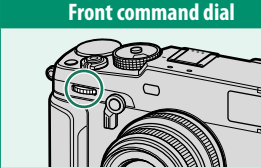
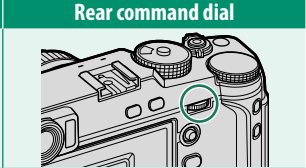
Rotate or press the command dials to:

	Front command dial	Rear command dial
 <p><b>Rotate</b></p>	 <ul style="list-style-type: none"> <li>• Select menu tabs or page through menus</li> <li>• Adjust aperture<sup>1,2</sup></li> <li>• Adjust exposure compensation<sup>2,5</sup></li> <li>• Adjust sensitivity<sup>2,3</sup></li> <li>• View other pictures during playback</li> </ul>	 <ul style="list-style-type: none"> <li>• Highlight menu items</li> <li>• Choose the desired combination of shutter speed and aperture (program shift)</li> <li>• Choose a shutter speed<sup>2</sup></li> <li>• Adjust settings in the quick menu</li> <li>• Choose the size of the focus frame</li> <li>• Zoom in or out in full frame playback</li> <li>• Zoom in or out in multi-frame playback</li> </ul>
 <p><b>Press</b></p>	—	<ul style="list-style-type: none"> <li>• Perform the function assigned to the <b>DIAL</b> function button</li> <li>• Zoom in on the active focus point<sup>4</sup></li> <li>• Choose the manual focus mode focus display<sup>4</sup></li> <li>• Zoom in on the active focus point during playback</li> </ul>

1 Aperture set to **A** (auto) and lens equipped with aperture ring or **COMMAND** selected for **FUNCTION/DIAL SETTING > APERTURE RING SETTING (A)**.

2 Can be changed using **FUNCTION/DIAL SETTING > COMMAND DIAL SETTING**.

3 **C** selected for sensitivity.

4 Available only if **FOCUS CHECK** is assigned to a function button.

5 Exposure compensation dial rotated to **C**.

## The Indicator Lamp

Camera status is shown by the indicator lamp.

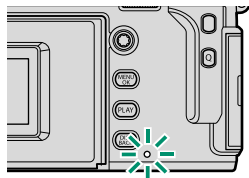

Indicator lamp	Camera status
Glows green	Focus locked.
Blinks green	Focus or slow shutter speed warning. Pictures can be taken.
Blinks green and orange	<ul style="list-style-type: none"> <li>• <b>Camera on:</b> Recording pictures. Additional pictures can be taken.</li> <li>• <b>Camera off:</b> Uploading pictures to a smartphone or tablet.*</li> </ul>
Glows orange	Recording pictures. No additional pictures can be taken at this time.
Blinks red	Lens or memory error.

\* Displayed only if pictures are selected for upload.



- Warnings may also appear in the display.
- The indicator lamp remains off while your eye is to the viewfinder.
- The **MOVIE SETTING > TALLY LIGHT** option can be used to choose the lamp (indicator or AF-assist) that lights during movie recording and whether the lamp blinks or remains steady.

## Camera Displays

The following are displayed in the sub monitor, viewfinder (OVF or EVF), and LCD monitor during shooting.

! For illustrative purposes, displays are shown with all indicators lit.

### The Sub Monitor

The information displayed in the sub monitor includes the shutter speed, aperture, and sensitivity. Use the **SCREEN SET-UP > SUB MONITOR** option to choose from **CLASSIC** and **STANDARD** displays and select the items appearing in the **STANDARD** display.

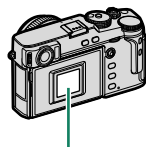

Sub monitor

#### CLASSIC



#### STANDARD



#### The "Classic" Display

The "classic" display is inspired by the memo holders formerly seen on film cameras, and can be used in much the same way.





① Flash (TTL) mode.....	261	②4 Aperture.....	59, 64, 65
② Out-of-frame indicators.....	46	②5 Distance indicator <sup>2</sup> .....	77
③ Flash compensation.....	261	②6 Shutter speed.....	59, 60, 65
④ Boost mode.....	226	②7 TTL lock.....	150, 218, 250
⑤ IS mode <sup>2</sup> .....	144	②8 AE lock.....	85, 222
⑥ Control lock <sup>3</sup> .....	224	②9 Metering.....	81
⑦ Sports finder mode.....	132	③0 Shooting mode.....	58
⑧ Depth-of-field preview.....	64, 77	③1 Focus mode <sup>2</sup> .....	68
⑨ Location data download status.....	237, 270	③2 Focus indicator <sup>2</sup> .....	69
⑩ Bluetooth ON/OFF.....	231	③3 Manual focus indicator <sup>2</sup> .....	68, 75
⑪ Image transfer status.....	231, 270	③4 AF lock.....	85, 222
⑫ Card slot options.....	34, 228	③5 Histogram.....	20
⑬ Number of available frames <sup>1</sup> .....	316	③6 Dynamic range.....	107
⑭ Image size.....	98	③7 D-range priority.....	108
⑮ Image quality.....	99	③8 Film simulation.....	100
⑯ Battery level.....	39	③9 F-Log recording.....	158
⑰ External power source in use.....	37	④0 White balance.....	104
⑱ Bright frame.....	16	④1 AWB lock.....	222
⑲ Virtual horizon.....	20	④2 Exposure indicator.....	65, 82
⑳ Temperature warning.....	315	④3 AF+MF indicator <sup>2</sup> .....	124
㉑ Focus frame.....	72, 84	④4 Shutter type.....	142
㉒ Sensitivity.....	79	④5 Continuous mode.....	90
㉓ Exposure compensation.....	82	④6 Self-timer indicator.....	133

1 Shows "9999" if there is space for over 9999 frames.

2 Not displayed when **ON** is selected for **SCREEN SET-UP > LARGE INDICATORS MODE(EVF/OVF)**.

3 Displayed when controls have been locked by pressing and holding the **MENU/OK** button. Control lock can be ended by pressing and holding the **MENU/OK** button again.

### The Bright Frame

The bright frame shows the area that will appear in the final photograph. Its size varies with lens focal length.



Frame brightness can be assigned to a function button for quick access (📖 248).

# The EVF/LCD Monitor

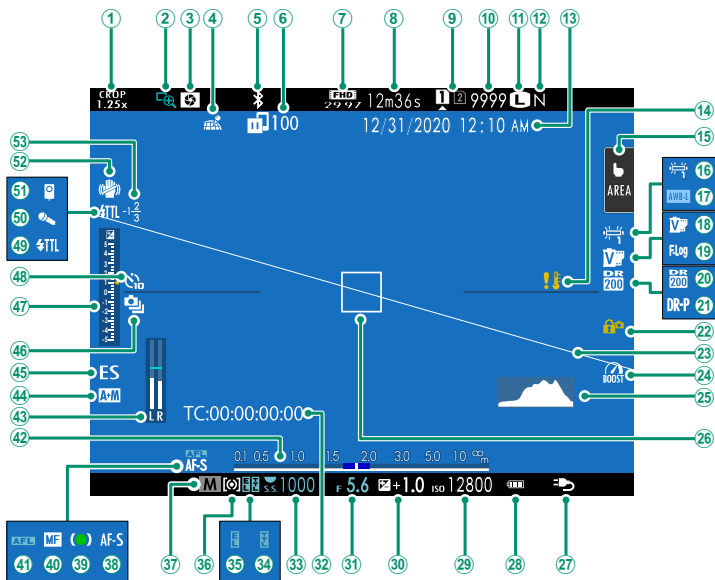

① Sports finder mode.....	132	②8 Battery level.....	39
② Focus check.....	78, 125	②9 Sensitivity.....	79
③ Depth-of-field preview.....	64, 77	③0 Exposure compensation.....	82
④ Location data download status.....	237, 270	③1 Aperture.....	59, 64, 65
⑤ Bluetooth ON/OFF.....	231	③2 Time code.....	163
⑥ Image transfer status.....	231, 270	③3 Shutter speed.....	59, 60, 65
⑦ Movie mode <sup>3</sup> .....	50, 152	③4 TTL lock.....	150, 218, 250
⑧ Time remaining <sup>3</sup> .....	51	③5 AE lock.....	85, 222
⑨ Card slot options.....	34, 228	③6 Metering.....	81
⑩ Number of available frames <sup>1</sup> .....	316	③7 Shooting mode.....	58
⑪ Image size.....	98	③8 Focus mode <sup>2</sup> .....	68
⑫ Image quality.....	99	③9 Focus indicator <sup>2</sup> .....	69
⑬ Date and time.....	40, 42, 195	④0 Manual focus indicator <sup>2</sup> .....	68, 75
⑭ Temperature warning.....	315	④1 AF lock.....	85, 222
⑮ Touch screen mode <sup>4</sup> .....	22, 128	④2 Distance indicator <sup>2</sup> .....	77
⑯ White balance.....	104	④3 Recording level <sup>2,3</sup> .....	161
⑰ AWB lock.....	222	④4 AF+MF indicator <sup>2</sup> .....	124
⑱ Film simulation.....	100	④5 Shutter type.....	142
⑲ F-Log recording.....	158	④6 Continuous mode.....	90
⑳ Dynamic range.....	107	④7 Exposure indicator.....	65, 82
㉑ D-range priority.....	108	④8 Self-timer indicator.....	133
㉒ Control lock <sup>5</sup> .....	224	④9 Flash (TTL) mode.....	261
㉓ Virtual horizon.....	20	⑤0 Microphone.....	163
㉔ Boost mode.....	226	⑤1 Remote release.....	163
㉕ Histogram.....	20	⑤2 IS mode <sup>2</sup> .....	144
㉖ Focus frame.....	72, 84	⑤3 Flash compensation.....	261
㉗ External power source in use.....	37		

1 Shows "9999" if there is space for over 9999 frames.

2 Not displayed in the EVF if **LARGE INDICATORS MODE(EVF/OVF)** is selected for **SCREEN SET-UP** or in the LCD monitor if **LARGE INDICATORS MODE(LCD)** is selected.

3 Displayed during movie recording only.

4 Displayed in the LCD monitor only. Camera functions can also be accessed via touch controls.

5 Displayed when controls have been locked by pressing and holding the **MENU/OK** button. Control lock can be ended by pressing and holding the **MENU/OK** button again.

## Adjusting Display Brightness

The brightness and hue of the viewfinder and LCD monitor can be adjusted using the items in the **SCREEN SET-UP** menu. Choose **EVF BRIGHTNESS** or **EVF COLOR** to adjust viewfinder brightness or hue, **LCD BRIGHTNESS** or **LCD COLOR** to do the same for the LCD monitor.

## Display Rotation

When **ON** is selected for **SCREEN SET-UP > AUTOROTATE DISPLAYS**, the indicators in the viewfinder and LCD monitor automatically rotate to match camera orientation.

## Bright Frame Simulation

The angle of view covered by the bright frame in the OVF/ERF display varies with the focal length of the lens. The bright frame simulation display can be viewed by pulling the viewfinder selector right.

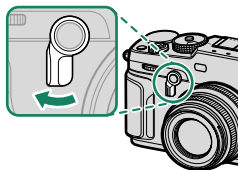
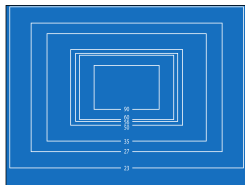

## The DISP/BACK Button

The **DISP/BACK** button controls the display of indicators in the viewfinder and LCD monitor.

 Indicators for the EVF, OVF, and LCD must be selected separately. To choose the indicators displayed in the EVF and OVF, place your eye to the viewfinder and press the **DISP/BACK** button.

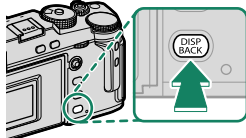

### Viewfinder (OVF)

*Standard indicators*

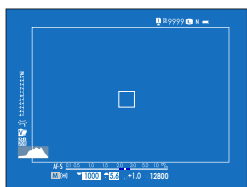

*Full screen  
(no indicators)*

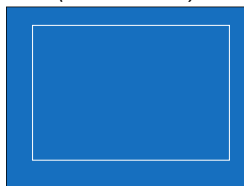

### Viewfinder (EVF)

*Standard indicators*



*Full screen  
(no indicators)*



## LCD Monitor

*Standard indicators*

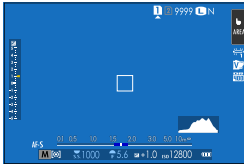

*No indicators*



*Info display*



1

Before You Begin

## Customizing the Standard Display

To choose the items shown in the standard indicator display:

### 1 Display standard indicators.

Use the **DISP/BACK** button to display standard indicators.

### 2 Select **DISP. CUSTOM SETTING**.

Select **SCREEN SET-UP > DISP. CUSTOM SETTING** in the setup menu.

### 3 Highlight **OVF** or **EVF/LCD** and press **MENU/OK**.

### 4 Choose items.

Highlight items and press **MENU/OK** to select or deselect.

- FRAMING GUIDELINE
- ELECTRONIC LEVEL
- FOCUS FRAME
- AF DISTANCE INDICATOR
- MF DISTANCE INDICATOR
- HISTOGRAM
- LIVE VIEW HIGHLIGHT ALERT\*
- SHOOTING MODE
- APERTURE/S-SPEED/ISO
- INFORMATION BACKGROUND\*
- Expo. Comp. (Digit)
- Expo. Comp. (Scale)
- FOCUS MODE
- PHOTOMETRY
- SHUTTER TYPE
- FLASH
- CONTINUOUS MODE
- DUAL IS MODE
- TOUCH SCREEN MODE\*
- WHITE BALANCE
- FILM SIMULATION
- DYNAMIC RANGE
- BOOST MODE
- FRAMES REMAINING
- IMAGE SIZE/QUALITY
- MOVIE MODE & REC. TIME\*
- IMAGE TRANSFER ORDER
- MIC LEVEL\*
- GUIDANCE MESSAGE
- BATTERY LEVEL
- FRAMING OUTLINE\*

\* EVF/LCD monitor only.

### 5 Save changes.

Press **DISP/BACK** to save changes.

### 6 Exit the menus.

Press **DISP/BACK** as needed to exit the menus and return to the shooting display.

### Virtual Horizon

Selecting **ELECTRONIC LEVEL** displays a virtual horizon. The camera is level when the two lines overlap. Note that the virtual horizon may not be displayed if the camera lens is pointed up or down. For a 3D display (shown), press the function button to which **ELECTRONIC LEVEL** is assigned (📖 216, 248).

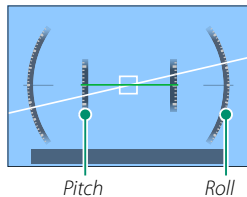

### Framing Outline

Enable **FRAMING OUTLINE** to make the borders of the frame easier to see against dark backgrounds.

### Histograms

Histograms show the distribution of tones in the image. Brightness is shown by the horizontal axis, the number of pixels by the vertical axis.

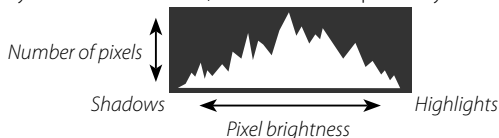

- **Optimal exposure:** Pixels are distributed in an even curve throughout the tone range.
- **Overexposed:** Pixels are clustered on the right side of the graph.
- **Underexposed:** Pixels are clustered on the left side of the graph.

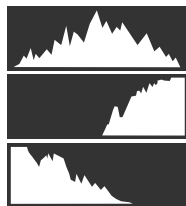

To view separate RGB histograms and a display showing areas of the frame that will be overexposed at current settings superimposed on the view through the lens, press the function button to which **HISTOGRAM** is assigned (📖 216, 248).

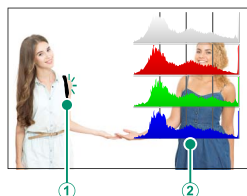

- ① *Overexposed areas blink*
- ② *RGB histograms*



## Using the Menu

To display the menu, press **MENU/OK**.

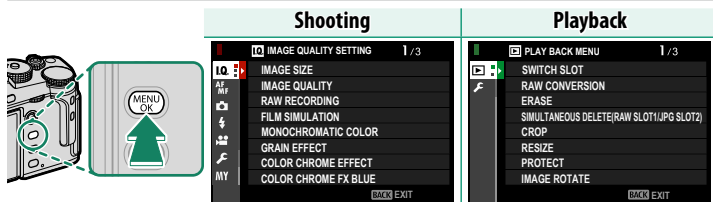

To navigate the menus:

- 1 Press **MENU/OK** to display the menus.

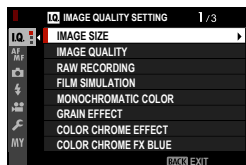

- 2 Press the focus stick (focus lever) left to highlight the tab for the current menu.

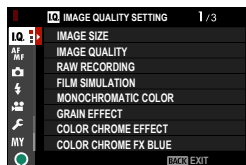

Tab

- 3 Press the focus stick up or down to highlight the tab (**IQ**, **AF/MF**, **Q**, **F**, **M**, **MY**, **Q** or **F**) containing the desired item.
- 4 Press the focus stick right to place the cursor in the menu.

 Use the front command dial to select menu tabs or page through menus and the rear command dial to highlight menu items.

## Touch Screen Mode

The LCD monitor also functions as a touch screen.

### Shooting Touch Controls



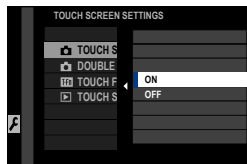

To enable touch controls, select **ON** for **▶** **BUTTON/DIAL SETTING > TOUCH SCREEN SETTING > ▶** **TOUCH SCREEN SETTING**.

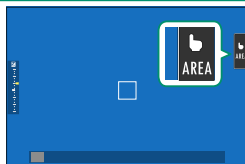

## LCD Monitor

The operation performed can be selected by tapping the touch screen mode indicator in the display. Touch controls can be used for the following operations:



Mode	Description
 <b>TOUCH SHOOTING</b>	Tap your subject in the display to focus and release the shutter. In burst mode, pictures will be taken while you keep your finger on the display.
 <b>AF</b>	<ul style="list-style-type: none"> <li>In focus mode <b>S</b> (AF-S), the camera focuses when you tap your subject in the display. Focus locks at the current distance until you tap the <b>AF OFF</b> icon.</li> <li>In focus mode <b>C</b> (AF-C), the camera initiates focus when you tap your subject display. The camera will continue to adjust focus for changes in the distance to the subject until you tap the <b>AF OFF</b> icon.</li> <li>In manual focus mode (MF), you can tap the display to focus on the selected subject using autofocus.</li> </ul>
 <b>AF OFF</b>	
 <b>AREA</b>	
 <b>OFF</b>	Touch controls disabled.

! Different touch controls are used during focus zoom (130).

- To disable touch controls and hide the touch screen mode indicator, select **OFF** for **FUNCTION/DIAL SETTING > TOUCH SCREEN SETTING > TOUCH SCREEN SETTING**.
- Touch control settings can be adjusted using **AF/MF SETTING > TOUCH SCREEN MODE**. For information on the touch controls available during movie recording, see “Movie Recording (TOUCH SCREEN MODE; 129)”.

## Muting Movie Controls

Movie settings can be adjusted using touch-screen controls, preventing the sounds made by camera controls being recorded with the movie. When **ON** is selected for **MOVIE SETTING > MOVIE SILENT CONTROL** in the shooting menu, a **SET** icon will be displayed in the LCD



**SET** icon

monitor; tap the icon to access the following controls:

- SHUTTER SPEED\*
- APERTURE\*
- EXPOSURE COMPENSATION
- ISO
- INTERNAL MIC LEVEL ADJUSTMENT/EXTERNAL MIC LEVEL ADJUSTMENT
- WIND FILTER
- HEADPHONES VOLUME
- FILM SIMULATION
- WHITE BALANCE

\* Selecting **ON** for **MOVIE SETTING > MOVIE SILENT CONTROL** disables dial controls.

## Touch Function

Functions can be assigned to the following flick gestures in much the same way as function buttons (📖 246):

- Flick up: **T-Fn1**
- Flick left: **T-Fn2**
- Flick right: **T-Fn3**
- Flick down: **T-Fn4**

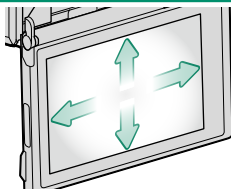

- In some cases, touch-function flick gestures display a menu; tap to select the desired option.
- Touch-function gestures are disabled by default. To enable touch-function gestures, select **ON** for **🔊 BUTTON/DIAL SETTING > TOUCH SCREEN SETTING > T-Fn TOUCH FUNCTION**.

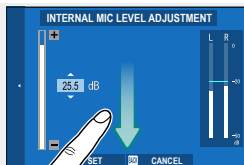

## Playback Touch Controls

When **ON** is selected for **▶ BUTTON/DIAL SETTING > TOUCH SCREEN SETTING > ▶ TOUCH SCREEN SETTING**, touch controls can be used for the following playback operations:

- **Swipe:** Swipe a finger across the display to view other images.



- **Pinch-out:** Place two fingers on the display and spread them apart to zoom in.



- **Pinch-in:** Place two fingers on the display and slide them together to zoom out.



Pictures can be zoomed out until the entire image is visible but no further.

- **Double-tap:** Tap the display twice to zoom in on the focus point.



- **Drag:** View other areas of the image during playback zoom.

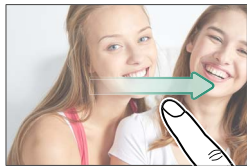

## First Steps

# 2

## Attaching the Strap

Attach the strap clips to the camera and then attach the strap.

### 1 Attach a protective cover.

Place a protective cover over the eye-let as shown, with the black side of the cover toward the camera.

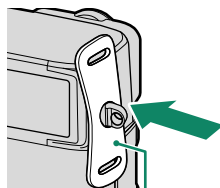

Protective cover

### 2 Open a strap clip.

Use the clip attaching tool (A) to open a strap clip (B).

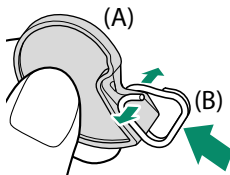

### 3 Slide the clip onto the tool.

Slide the clip onto the tool so that it hooks over the projection.

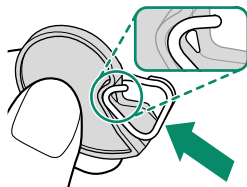



**4 Place the strap clip on an eyelet.**

Hook the strap eyelet in the clip opening. Remove the tool, using the other hand to keep the clip in place.

 Keep the tool in a safe place, as you will need it to open the strap clips when removing the strap.

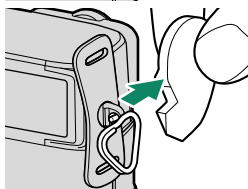
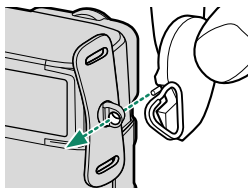
**5 Pass the clip through the eyelet.**

Rotate the clip fully through the eyelet until it clicks closed.

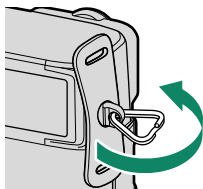
**6 Fasten the strap.**

Insert the strap through a protective cover and strap clip and fasten the buckle as shown.

 To avoid dropping the camera, be sure the strap is correctly secured.

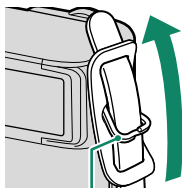

Strap clip

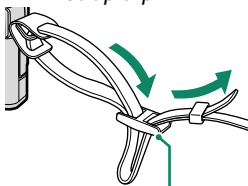

Buckle

Repeat the above steps for the second eyelet.

## Attaching a Lens

The camera can be used with lenses for the FUJIFILM X-mount.

Remove the body cap from the camera and the rear cap from the lens. Place the lens on mount, keeping the marks on the lens and camera aligned (①), and then rotate the lens until it clicks into place (②).

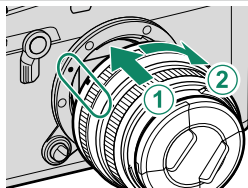

- ⓘ When attaching lenses, ensure that dust or other foreign matter does not enter the camera.
- Be careful not to touch the camera's internal parts.
- Rotate the lens until it clicks securely into place.
- Do not press the lens release button while attaching the lens.

### Removing Lenses

To remove the lens, turn the camera off, then press the lens release button (①) and rotate the lens as shown (②).

- ⓘ To prevent dust accumulating on the lens or inside the camera, replace the lens caps and camera body cap when the lens is not attached.

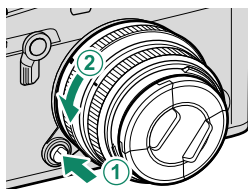

### Lenses and Other Optional Accessories

The camera can be used with lenses and accessories for the FUJIFILM X-mount.

- ⓘ Observe the following precautions when attaching or removing (exchanging) lenses.
- Check that the lenses are free of dust and other foreign matter.
- Do not change lenses in direct sunlight or under another bright light source. Light focused into the interior of the camera could cause it to malfunction.
- Attach the lens caps before exchanging lenses.

## Inserting the Battery

Insert the battery in the camera as described below.

### 1 Open the battery-chamber cover.

Slide the battery-chamber latch as shown and open the battery-chamber cover.

- ⚠ • Do not open the battery-chamber cover when the camera is on. Failure to observe this precaution could damage image files or memory cards.
- Do not use excessive force when handling the battery-chamber cover.

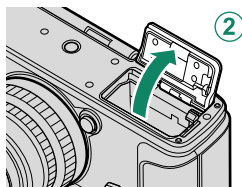
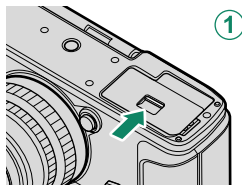

### 2 Insert the battery as shown.

- ⚠ • Insert the battery in the orientation shown. *Do not use force or attempt to insert the battery upside down or backwards.*
- Confirm that the battery is securely latched.

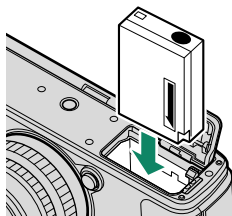

### 3 Close the battery-chamber cover.

Close and latch the cover.

**!** If the cover does not close, check that the battery is in the correct orientation. Do not attempt to force the cover shut.

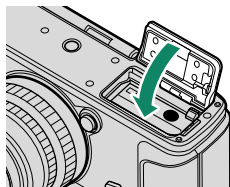

### Removing the Battery

Before removing the battery, *turn the camera off* and open the battery-chamber cover.

To remove the battery, press the battery latch to the side, and slide the battery out of the camera as shown.

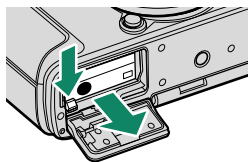

**!** The battery may become hot when used in high-temperature environments. Observe caution when removing the battery.

## Inserting Memory Cards

Pictures are stored on memory cards (sold separately).

 The camera can be used with two cards, one in each of its two slots.

### 1 Open the memory card slot cover.

Unlatch and open the cover.

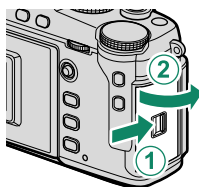

 Do not open the memory card-slot cover when the camera is on. Failure to observe this precaution could damage image files or memory cards.

### 2 Insert the memory card.

Holding the card in the orientation shown, slide it in until it clicks into place at the back of the slot. Close and latch the memory card slot cover.

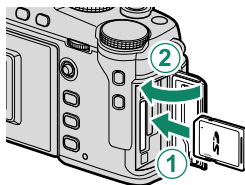

 Be sure card is in the correct orientation; do not insert at an angle or use force.

### 3 Format the memory card ( 194).

 Format memory cards before first use, and be sure to reformat all memory cards after using them in a computer or other device.

## Removing Memory Cards

Before removing memory cards, *turn the camera off* and open the memory card slot cover.

Press and release the card to eject it part way (to prevent the card falling from the slot, press the center of the card and release it slowly, without removing your finger from the card). The card can then be removed by hand.

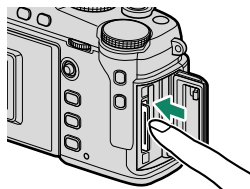

## Using Two Cards

The camera can be used with two cards, one in each of its two slots. At default settings, photos are saved to the card in the second slot only when the card in the first slot is full. This can be changed using **SAVE DATA SET-UP > CARD SLOT SETTING (STILL IMAGE)**.

Option	Description	Display
<b>SEQUENTIAL</b> (default)	The card in the second slot is used only when the card in the first slot is full. If the second slot is selected for <b>SAVE DATA SET-UP &gt; SELECT SLOT (CAMERA SEQUENTIAL)</b> , recording will start on the card in the second slot and switch to the first slot when the card in the second slot is full.	
<b>BACKUP</b>	Each picture is recorded twice, once to each card.	
<b>RAW / JPEG</b>	As for <b>SEQUENTIAL</b> , except that the RAW copy of pictures taken with <b>FINE+RAW</b> or <b>NORMAL+RAW</b> selected for <b>IMAGE QUALITY SETTING &gt; IMAGE QUALITY</b> will be saved to the card in the first slot and the JPEG copy to the card in the second slot.	

The card used to store movies can be selected using **SAVE DATA SET-UP > SELECT SLOT (CAMERA SEQUENTIAL)**.

## Compatible Memory Cards

- The camera can be used with SD, SDHC, and SDXC memory cards. Both the UHS-I and UHS-II bus interfaces are supported.
- To record movies, use cards with a UHS speed class of 3 or better or a video speed class of V30 or better.
- A list of supported memory cards is available on the Fujifilm website. For details, visit: [http://www.fujifilm.com/support/digital\\_cameras/compatibility/](http://www.fujifilm.com/support/digital_cameras/compatibility/).

- !** • Do not turn the camera off or remove the memory card while the memory card is being formatted or data are being recorded to or deleted from the card. Failure to observe this precaution could damage the card.
- Memory cards can be locked, making it impossible to format the card or to record or delete images. Before inserting a memory card, slide the write-protect switch to the unlocked position.
- 
- Memory cards are small and can be swallowed; keep out of reach of children. If a child swallows a memory card, seek medical assistance immediately.
  - miniSD or microSD adapters that are larger or smaller than memory cards may not eject normally; if the card does not eject, take the camera to an authorized service representative. Do not forcibly remove the card.
  - Do not affix labels or other objects to memory cards. Peeling labels can cause camera malfunction.
  - Movie recording may be interrupted with some types of memory card.
  - Formatting a memory card in the camera creates a folder in which pictures are stored. Do not rename or delete this folder or use a computer or other device to edit, delete, or rename image files. Always use the camera to delete pictures; before editing or renaming files, copy them to a computer and edit or rename the copies, not the originals. Renaming the files on the camera can cause problems during playback.

## Charging the Battery

The battery is not charged at shipment. Charge the battery before use.

- An NP-W126S rechargeable battery is supplied with the camera.
  - Turn the camera off for charging.
- The camera can be charged via USB. USB charging is available with computers with a manufacturer-approved operating system and USB interface.

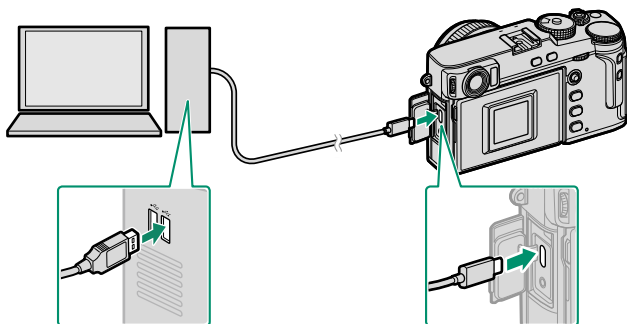

*Leave the computer on during charging.*

- The battery will not charge while the camera is on.
  - Connect the supplied USB cable.
  - Connect the camera directly to the computer; do not use a USB hub or keyboard.
  - Charging stops if the computer enters sleep mode. To resume charging, activate the computer and disconnect and reconnect the USB cable.
  - Charging may not be supported depending on the model of computer, computer settings, and the computer's current state.
  - The battery takes about 5 hours to charge with a charging input of 5 V/500 mA.
- To charge the battery from a household AC power outlet, use a BC-W126S battery charger (available separately).



**Charge Status**

The indicator lamp shows battery charge status as follows:



Indicator lamp	Battery status
On	Battery charging
Off	Charging complete
Blinks	Battery fault

- ❗ Do not affix labels or other objects to the battery. Failure to observe this precaution could make it impossible to remove the battery from the camera.
- Do not short the battery terminals. The battery could overheat.
- Read the cautions in “The Battery and Power Supply”.
- Use only genuine Fujifilm rechargeable batteries designated for use in this camera. Failure to observe this precaution could result in product malfunction.
- Do not remove the labels from the battery or attempt to split or peel the outer casing.
- The battery gradually loses its charge when not in use. Charge the battery one or two days before use.
- If the battery fails to hold a charge, it has reached the end of its charging life and must be replaced.
- Remove dirt from the battery terminals with a clean, dry cloth. Failure to observe this precaution could prevent the battery from charging.
- Note that charging times increase at low or high temperatures.

- 🔌 If the camera is turned on during charging, charging will end and the USB connection will instead be used to power the camera. The battery level will begin to gradually decline (📖 236).
- The camera will display an “external power source” icon when powered via USB.

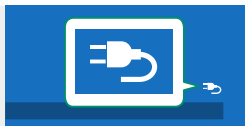

## Turning the Camera On and Off

Use the **ON/OFF** switch to turn the camera on and off.

Slide the switch to **ON** to turn the camera on, or to **OFF** to turn the camera off.

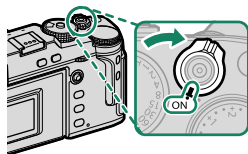

**!** Fingerprints and other marks on the lens or viewfinder can affect pictures or the view through the viewfinder. Keep the lens and viewfinder clean.

- 📖**
- Pressing the **PLAY** button during shooting starts playback.
  - Press the shutter button halfway to return to shooting mode.
  - The camera will turn off automatically if no operations are performed for the length of time selected for **POWER MANAGEMENT > AUTO POWER OFF**. To reactivate the camera after it has turned off automatically, press the shutter button halfway or turn the **ON/OFF** switch to **OFF** and then back to **ON**.

## Checking the Battery Level

After turning the camera on, check the battery level in the display.

Battery level is shown as follows:

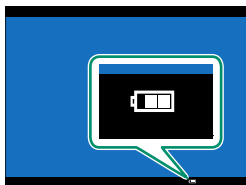

Indicator	Description
	Battery partially discharged.
	Battery about 80% full.
	Battery about 60% full.
	Battery about 40% full.
	Battery about 20% full.
 (red)	Low battery. Charge as soon as possible.
 (blinks red)	Battery exhausted. Turn camera off and recharge battery.

## Basic Setup

When you turn the camera on for the first time, you can choose a language and set the camera clock. At default settings, you can also pair the camera with a smartphone or tablet so that you can later synchronize the clocks or download pictures. Follow the steps below when turning the camera on for the first time.

 If you intend to pair the camera with a smartphone or tablet, install and launch the latest version of the FUJIFILM Camera Remote App on the smart device before proceeding. For more information, visit: [http://app.fujifilm-dsc.com/en/camera\\_remote/](http://app.fujifilm-dsc.com/en/camera_remote/)

### 1 Turn the camera on.

A language-selection dialog will be displayed.

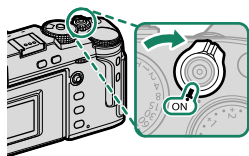

### 2 Choose a language.

Highlight a language and press **MENU/OK**.

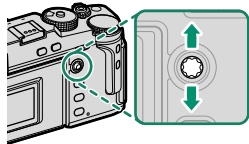

### 3 Pair the camera with the smartphone or tablet.

Press **MENU/OK** on the camera and tap **PAIRING REGISTRATION** in FUJIFILM Camera Remote.

 To skip pairing, press **DISP/BACK**.

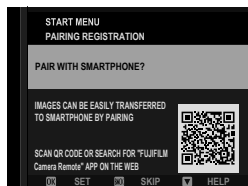

#### 4 Check the time.

When pairing is complete, you will be prompted to set the camera clock to the time reported by the smartphone or tablet. Check that the time is correct.

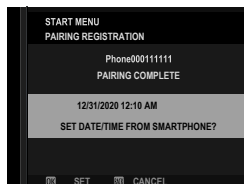

 To set the clock manually, press **DISP/BACK** (📖 42).

#### 5 Synchronize the camera settings with the settings configured on your smartphone or tablet.

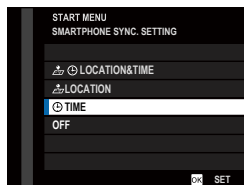

 The option selected can be changed at any time using **CONNECTION SETTING > Bluetooth SETTINGS**.

#### 6 Set the clock.

Press **MENU/OK** to set the camera clock to the time reported by the smartphone or tablet and exit to shooting mode.

 If the battery is removed for an extended period, the camera clock will be reset and the language-selection dialog will be displayed when the camera is turned on.



#### Skipping the Current Step

If you skip a step, a confirmation dialog will be displayed; select **NO** to avoid repeating any steps you skipped the next time the camera is turned on.

## Choosing a Different Language

To change the language:

---

- 1 Display language options.**  
Select  **USER SETTING** >  **言語/LANG..**
- 2 Choose a language.**  
Highlight the desired option and press **MENU/OK**.

## Changing the Time and Date

To set the camera clock:

---

- 1 Display DATE/TIME options.**  
Select  **USER SETTING** > **DATE/TIME**.
- 2 Set the clock.**  
Press the focus stick (focus lever) left or right to highlight the year, month, day, hour, or minute and press up or down to change. Press **MENU/OK** to set the clock.

# Basic Photography and Playback

# 3

## Taking Photographs (Mode P)

This section describes how to take pictures using program AE (mode P). See pages 58–66 for information on **S**, **A**, and **M** modes.

- 1 Press the **DRIVE** button and select **STILL IMAGE** in the drive-mode menu.

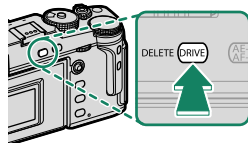

- 2 Adjust settings for program AE.

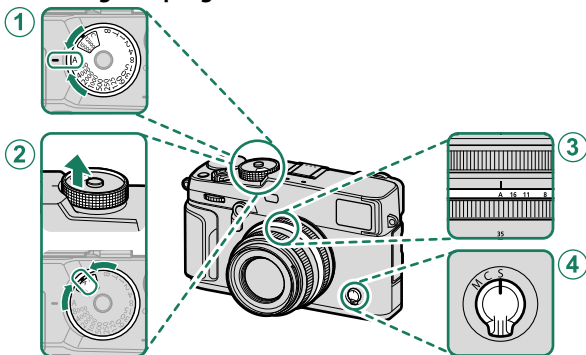

	Setting	
①	<b>Shutter speed</b>	<b>A</b> (auto) 58
②	<b>Sensitivity</b>	<b>A</b> (auto) 79
③	<b>Aperture</b>	<b>A</b> (auto) 58
④	<b>Focus mode</b>	<b>S</b> (single AF) 68

To choose another shutter speed after selecting **A** (auto), hold the dial lock release and rotate the shutter speed dial.



### 3 Check the shooting mode.

Confirm that **P** appears in the display.

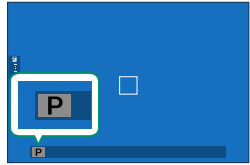

### 4 Ready the camera.

- Hold the camera steady with both hands and brace your elbows against your sides. Shaking or unsteady hands can blur your shots.

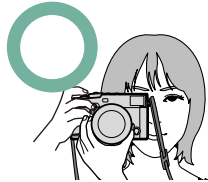

- To prevent pictures that are out of focus or too dark (underexposed), keep your fingers and other objects away from the lens and AF-assist illuminator.

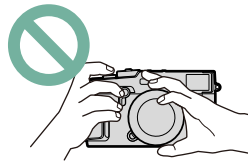

### 5 Frame the picture.

### 6 Focus.

Press the shutter button halfway to focus.

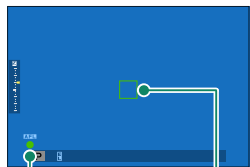

Focus indicator

Focus frame

- **If the camera is able to focus**, the focus frame and focus indicator will glow green.
- **If the camera is unable to focus**, the focus frame will turn red, **!AF** will be displayed, and the focus indicator will blink white.

- If the subject is poorly lit, the AF-assist illuminator may light to assist the focus operation.
- Focus and exposure will lock when the shutter button is pressed halfway. Focus and exposure remain locked while the button is kept in this position (AF/AE lock).
- The camera will focus on subjects at any distance in the macro and standard focus ranges for the lens.

## 7 Shoot.

Smoothly press the shutter button the rest of the way down to take the picture.

### Lenses with Zoom Rings

Use the zoom ring to frame the picture in the display. Rotate the ring left to zoom out, right to zoom in.

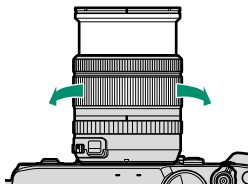

### Focal Lengths Under 23 mm

If the angle covered by the lens is wider than that covered by the OVF, out-of-frame indicators will appear at the corners of the display. Use the EVF or LCD monitor for accurate framing.



- ! In some cases, out-of-frame indicators will appear at a focal length of 23 mm.



## Viewing Pictures

Pictures can be viewed in the viewfinder or LCD monitor.

To view pictures full frame, press the **PLAY** button.



Additional pictures can be viewed by pressing the focus stick (focus lever) left or right or rotating the front command dial. Press the focus stick or rotate the dial right to view pictures in the order recorded, left to view pictures in reverse order. Keep the focus stick pressed to scroll rapidly to the desired frame.

 Pictures taken using other cameras are marked with a  ("gift image") icon to warn that they may not display correctly and that playback zoom may not be available.

### Two Memory Cards

If two memory cards are inserted, you can press and hold the **PLAY** button to choose a card for playback. You can also select a card using the  **PLAY BACK MENU > SWITCH SLOT** option.

## Deleting Pictures

Use the **DELETE** button to delete pictures.

**!** Deleted pictures cannot be recovered. Protect important pictures or copy them to a computer or other storage device before proceeding.

- 1 With a picture displayed full frame, press the **DELETE** button and select **FRAME**.

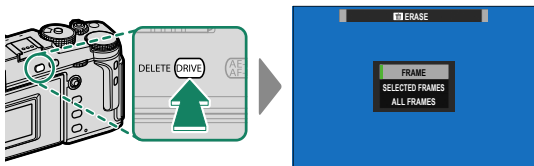

- 2 Press the focus stick (focus lever) left or right to scroll through pictures and press **MENU/OK** to delete (a confirmation dialog is not displayed). Repeat to delete additional pictures.

**!**

- Protected pictures cannot be deleted. Remove protection from any pictures you wish to delete (📖 180).
- Pictures can also be deleted from the menus using the **PLAY BACK MENU > ERASE** option (📖 176).

# Movie Recording and Playback

# 4

## Recording Movies

This section describes how to film movies in auto mode.

- 1 Press the **DRIVE** button and select **MOVIE** in the drive-mode menu.

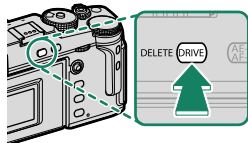

- 2 Adjust settings for program AE.

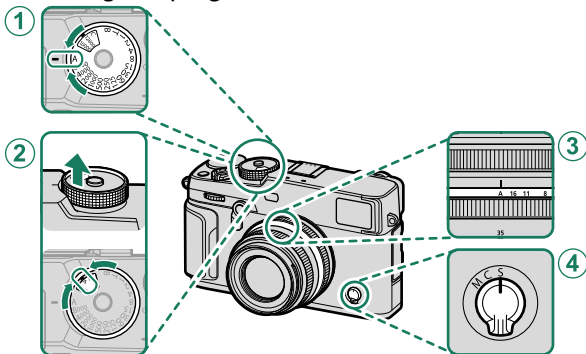

	Setting	
①	<b>Shutter speed</b>	A (auto) 58
②	<b>Sensitivity</b>	A (auto) 79
③	<b>Aperture</b>	A (auto) 58
④	<b>Focus mode</b>	S (single AF) 68

- ❗ To choose another shutter speed after selecting **A** (auto), hold the dial lock release and rotate the shutter speed dial.

- 3 Press the shutter button to start recording. A recording indicator (●) and the time remaining are displayed while recording is in progress.

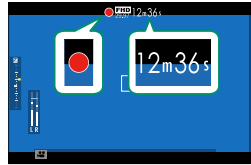

- 4 Press the button again to end recording. Recording ends automatically when the maximum length is reached or the memory card is full.

#### Using an External Microphone

Sound can be recorded with external microphones that connect using jacks 2.5 mm in diameter; microphones that require plug-in power cannot be used. See the microphone manual for details.

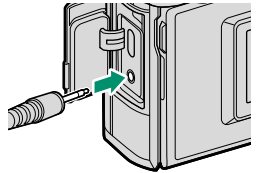

- ❗ • Sound is recorded via the built-in microphone or an optional external microphone. Do not cover the microphone during recording.
- Note that the microphone may pick up lens noise and other sounds made by the camera during recording.
- Vertical or horizontal streaks may appear in movies containing very bright subjects. This is normal and does not indicate a malfunction.





## Adjusting Movie Settings

- Frame size and rate can be selected using **MOVIE SETTING > MOVIE MODE**.
- To choose the card used to store movies, use **SAVE DATA SET-UP > SELECT SLOT (SEQUENTIAL)**.
- Focus mode is selected using the focus mode selector; for continuous focus adjustment, select **C**, or choose **S** and enable Intelligent Face Detection. Intelligent Face Detection is not available in focus mode **M**.

### Depth of Field

Choose low f-numbers to soften background details.



-  The indicator lamp lights while recording is in progress (the  **MOVIE SETTING** > **TALLY LIGHT** option can be used to choose the lamp—indicator or AF-assist—that lights during movie recording and whether the lamp blinks or remains steady). During recording, you can change exposure compensation by up to  $\pm 2$  EV and adjust zoom using the zoom ring on the lens (if available).
- If the lens is equipped with an aperture mode switch, select the aperture mode before beginning recording. If an option other than **A** is selected, shutter speed and aperture can be adjusted while recording is in progress.
- While recording is in progress, you can:
  - Adjust sensitivity
  - Refocus using any of the following methods:
    - Press the shutter button halfway
    - Press a function button to which **AF-ON** is assigned
    - Use touch screen controls
  - Display a histogram or artificial horizon by pressing the button to which **HISTOGRAM** or **ELECTRONIC LEVEL** has been assigned
- Recording may be unavailable at some settings, while in other cases settings may not apply during recording.
- To choose the focus area for movie recording, select  **MOVIE SETTING** >  **FOCUS AREA** and use the focus stick (focus lever) and rear command dial ( 72).

## Viewing Movies

View movies on the camera.

In full-frame playback, movies are identified by a  icon. Press the focus stick (focus lever) down to start movie playback.



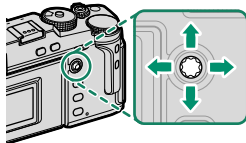

The following operations can be performed while a movie is displayed:

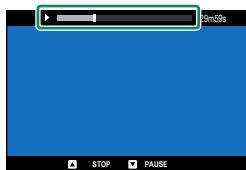

Focus stick (focus lever)	Full-frame playback	Playback in progress (▶)	Playback paused (⏸)
Up	—	End playback	
Down	Start playback	Pause playback	Start/resume playback
Left/right	View other pictures	Adjust speed	Single frame rewind/advance

Progress is shown in the display during playback.



 Do not cover the speaker during playback.

- Press **MENU/OK** to pause playback and display volume controls. Press the focus stick (focus lever) up or down to adjust the volume; press **MENU/OK** again to resume playback. Volume can also be adjusted using **SOUND SET-UP > PLAYBACK VOLUME**.
- Headphones and other audio output devices can be connected using third-party USB analog output audio adapters (320).

**Playback Speed**

Press the focus stick (focus lever) left or right to adjust playback speed during playback. Speed is shown by the number of arrows (▶ or ◀).



Arrows



# Taking Photographs

5

## P, S, A, and M Modes

P, S, A, and M modes give you varying degrees of control over shutter speed and aperture.

### Mode P: Program AE

Let the camera choose shutter speed and aperture for optimal exposure. Other values that produce the same exposure can be selected with program shift.

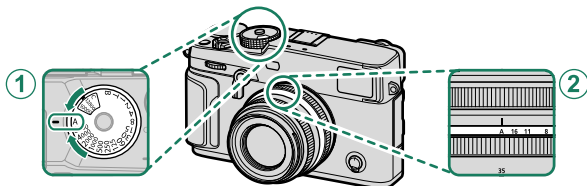

#### Setting

① Shutter speed	A (auto)
② Aperture	A (auto)

Confirm that **P** appears in the display.

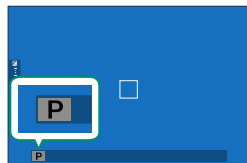

- ! If the subject is outside the metering range of the camera, the aperture display will show “---”.
- To choose another shutter speed after selecting **A** (auto), hold the dial lock release and rotate the shutter speed dial.

## Program Shift

If desired, you can rotate the rear command dial to select other combinations of shutter speed and aperture without altering exposure (program shift).

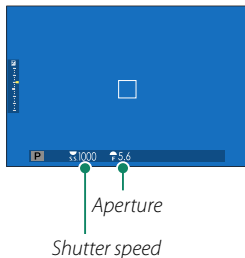

 Program shift is not available in any of the following circumstances:

- With flash units that support TTL auto
- When an auto option is selected for **IMAGE QUALITY SETTING > DYNAMIC RANGE**
- In movie mode

 To cancel program shift, turn the camera off.

## Mode S: Shutter-Priority AE

Choose a shutter speed and let the camera adjust aperture for optimal exposure.

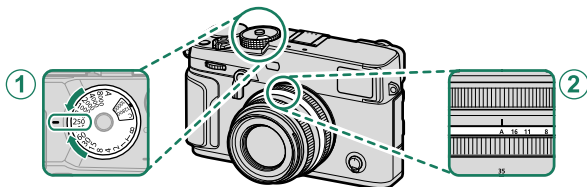

Setting	
① Shutter speed	User-selected
② Aperture	A (auto)

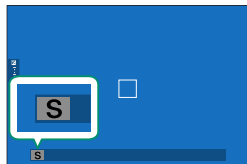

Confirm that **S** appears in the display.

- ❗ If the correct exposure cannot be achieved at the selected shutter speed, aperture will be displayed in red.
- If the subject is outside the metering range of the camera, the aperture display will show “— —”.
- To choose another shutter speed after selecting **A** (auto), hold the dial lock release and rotate the shutter speed dial.
- 📄 Shutter speed can also be adjusted in increments of  $\frac{1}{3}$  EV by rotating the rear command dial.
- Shutter speed can be adjusted while the shutter button is pressed halfway.



## Time (T)

Choose a shutter speed of **T** (time) for long time-exposures. Use of a tripod is recommended to prevent the camera moving during the exposure.

- 1 Set shutter speed to **T**.

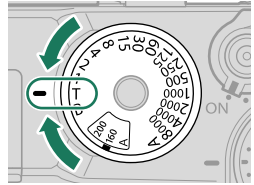

- 2 Rotate the rear command dial to choose a shutter speed.

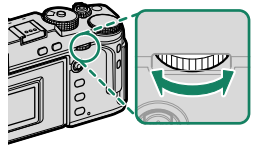

- 3 Press the shutter button all the way down to take a picture at the selected shutter speed. At speeds of 1 s or slower, a count-down timer will be displayed while the exposure is in progress.

 To reduce “noise” (mottling) in long time-exposures, select **ON** for **IMAGE QUALITY SETTING > LONG EXPOSURE NR.** Note that this may increase the time needed to record images after shooting.

## Bulb (B)

Choose a shutter speed of **B** (bulb) for long time-exposures in which you open and close the shutter manually. Use of a tripod is recommended to prevent the camera moving during the exposure.

- 1 Set shutter speed to **B**.

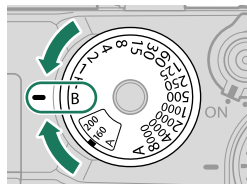

- 2 Press the shutter button all the way down. The shutter will remain open for up to 60 minutes while the shutter button is pressed; the display shows the time elapsed since the exposure started.



- Selecting an aperture of **A** fixes shutter speed at 30 s.
- To reduce “noise” (mottling) in long time-exposures, select **ON** for **IMAGE QUALITY SETTING > LONG EXPOSURE NR**. Note that this may increase the time needed to record images after shooting.

### Using a Remote Release

A remote release can be used for long time-exposures. When using an optional RR-100 remote release or an electronic release from third-party suppliers, connect it to the camera's remote release connector.

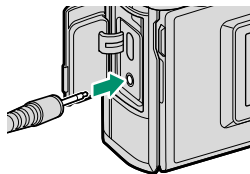

 A confirmation dialog will be displayed when a remote release is connected; press **MENU/OK** and select **REMOTE** for **MIC/REMOTE RELEASE**.

CHECK MIC/REMOTE RELEASE  
SETTING  
**OK** SET **BACK** SKIP

## Mode A: Aperture-Priority AE

Choose an aperture and let the camera adjust shutter speed for optimal exposure.

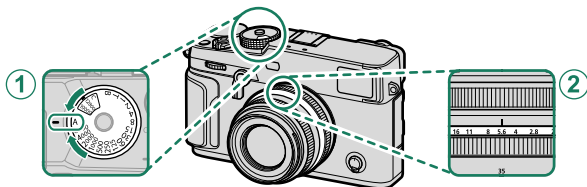

Setting	
① Shutter speed	A (auto)
② Aperture	User-selected

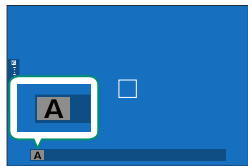

Confirm that **A** appears in the display.

- ❗ If the correct exposure cannot be achieved at the selected aperture, shutter speed will be displayed in red.
- If the subject is outside the metering range of the camera, the shutter speed display will show “— — —”.
- To choose another shutter speed after selecting **A** (auto), hold the dial lock release and rotate the shutter speed dial.

- 🔧 Rotate the lens aperture ring to adjust aperture.
- Aperture can be adjusted even while the shutter button is pressed halfway.

### Previewing Depth of Field

When **PREVIEW DEPTH OF FIELD** is assigned to a function button, pressing the button displays a  icon and stops aperture down to the selected setting, allowing depth of field to be previewed in the display.

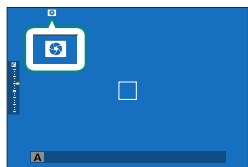

## Mode M: Manual Exposure

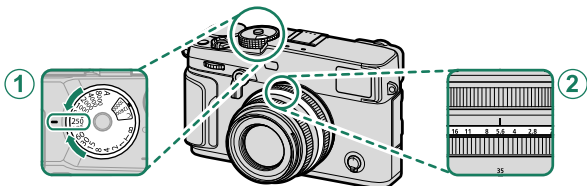

In manual mode, the user controls both shutter speed and aperture. Shots can be deliberately overexposed (brighter) or underexposed (darker), opening the door for a variety of individual creative expression. The amount the picture would be under- or over-exposed at current settings is shown by the exposure indicator; adjust shutter speed and aperture until the desired exposure is reached.

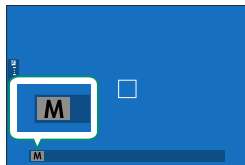

Setting	
①	<b>Shutter speed</b>   User-selected
②	<b>Aperture</b>   User-selected



Confirm that **M** appears in the display.

-  To choose another shutter speed after selecting **A** (auto), hold the dial lock release and rotate the shutter speed dial.
- 
  - Rotate the lens aperture ring to adjust aperture.
  - Shutter speed can be adjusted in increments of  $\frac{1}{3}$  EV by rotating the rear command dial.

**Exposure Preview**

To preview exposure in the LCD monitor, select an option other than **OFF** for  **SCREEN SET-UP > PREVIEW EXP./WB IN MANUAL MODE.**



Select **OFF** when using the flash or on other occasions on which exposure may change when the picture is taken.

## Autofocus

Take pictures using autofocus.

- 1 Rotate the focus mode selector to **S** or **C** (📖 68).

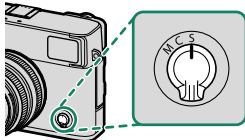

- 2 Choose an AF mode (📖 70).
- 3 Choose the position and size of the focus frame (📖 72).

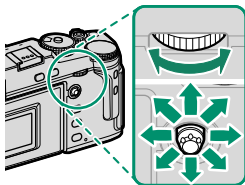

- 4 Take pictures.



For information on the autofocus system, visit:  
<http://fujifilm-x.com/af/en/index.html>

## Focus Mode

Use the focus mode selector to choose how the camera focuses.

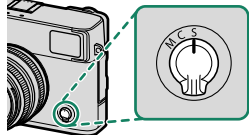

Choose from the following options:

Mode	Description
<b>S</b> (AF-S)	<b>Single AF:</b> Focus locks while the shutter button is pressed halfway. Choose for stationary subjects.
<b>C</b> (AF-C)	<b>Continuous AF:</b> Focus is continually adjusted to reflect changes in the distance to the subject while the shutter button is pressed halfway. Use for subjects that are in motion.
<b>M</b> (manual)	<b>Manual:</b> Focus manually using the lens focus ring. Choose for manual control of focus or in situations in which the camera is unable to focus using autofocus (📖 75).

- Regardless of the option selected, manual focus will be used when the lens is in manual focus mode.
- If **ON** is selected for **AF/MF SETTING > PRE-AF**, focus will be adjusted continuously in modes **S** and **C** even when the shutter button is not pressed.



## The Focus Indicator

Focus status is shown by the focus indicator.

Focus indicator	Focus status
( )	Camera focusing.
● (lights green)	Subject in focus; focus locked (focus mode <b>S</b> ).
(●) (lights green)	Subject in focus (focus mode <b>C</b> ). Focus is automatically adjusted for changes in distance to subject.
○ (blinks white)	Camera unable to focus.
<b>MF</b>	Manual focus (focus mode <b>M</b> ).

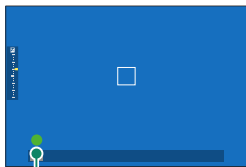

Focus indicator

## Autofocus Options (AF Mode)







Choose how the camera focuses in modes **S** and **C**.

- 1 Press **MENU/OK** and go to the shooting menu.
- 2 Select **AF/MF SETTING > AF MODE**.
- 3 Choose an AF mode.

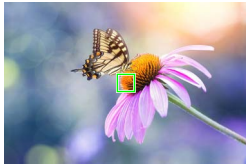

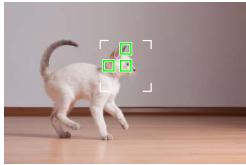

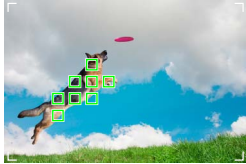



If **ON** is chosen for **BUTTON/DIAL SETTING > TOUCH SCREEN SETTING > TOUCH SCREEN SETTING**, AF-mode selection can also be performed using the **T-Fn2** (flick left) touch-function gesture. AF-mode selection can also be assigned to a function button (248).

How the camera focuses depends on the focus mode.

### Focus Mode **S** (AF-S)

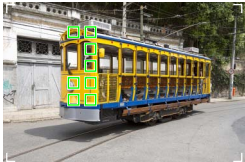
Option	Description	Sample image
 <b>SINGLE POINT</b>	Camera focuses on subject in selected focus point. Use for pin-point focus on selected subject.	
 <b>ZONE</b>	Camera focuses on subject in selected focus zone. Focus zones include multiple focus points, making it easier to focus on subjects in motion.	
 <b>WIDE</b>	Camera focuses automatically on high-contrast subjects; display shows areas in focus.	
 <b>ALL</b>	Rotate the rear command dial in the focus-point selection display (72, 73) to cycle through AF modes in the following order: <b>SINGLE POINT</b> , <b>ZONE</b> , and <b>WIDE</b> .	

**Focus Mode C (AF-C)**

Option	Description	Sample image
 <b>SINGLE POINT</b>	Focus tracks subject at selected focus point. Use for subjects moving toward or away from camera.	
 <b>ZONE</b>	Focus tracks subject in selected focus zone. Use for subjects that are moving fairly predictably.	
 <b>TRACKING</b>	Focus tracks subjects moving through wide area of frame.	
 <b>ALL</b>	Rotate the rear command dial in the focus-point selection display (📖 72, 73) to cycle through AF modes in the following order:  <b>SINGLE POINT</b> ,  <b>ZONE</b> , and  <b>TRACKING</b> .	

## Focus-Point Selection

Choose a focus point for autofocus.

### Viewing the Focus-Point Display





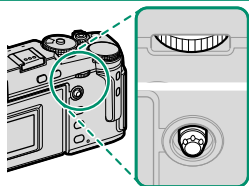

- 1 Press **MENU/OK** and go to the shooting menu.
- 2 Select **AF/MF SETTING > FOCUS AREA** to view the focus-point display.
- 3 Use the focus stick (focus lever) and rear command dial to choose a focus area.

 The focus point can also be selected using touch controls (☰ 22).

### Selecting a Focus Point

Use the focus stick (focus lever) to choose the focus point and the rear command dial to choose the size of the focus frame. The procedure varies with the option selected for AF mode.





AF mode	Focus stick		Rear command dial	
	 Tilt	 Press	 Rotate	 Press
	Select focus point	Select center focus point	Choose from 6 frame sizes	Restore original size
			Choose from 3 frame sizes	
			—	

## The Focus-Point Display

The focus-point display varies with the option selected for AF mode.

 Focus frames are shown by small squares (□), focus zones by the large squares.

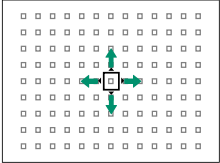
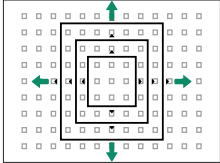
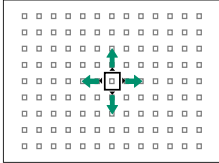
AF mode		
 SINGLE POINT	 ZONE	 WIDE/TRACKING
		
Number of points available can be selected using <b>AF/MF SETTING &gt; NUMBER OF FOCUS POINTS.</b>	Choose from zones with $7 \times 7$ , $5 \times 5$ , or $3 \times 3$ focus points.	Position focus frame over subject you want to track.

### Autofocus





Although the camera boasts a high-precision autofocus system, it may be unable to focus on the subjects listed below.

- Very shiny subjects such as mirrors or car bodies.
- Subjects photographed through a window or other reflective object.
- Dark subjects and subjects that absorb rather than reflect light, such as hair or fur.
- Insubstantial subjects, such as smoke or flame.
- Subjects that show little contrast with the background.
- Subjects positioned in front of or behind a high-contrast object that is also in the focus frame (for example, a subject photographed against a backdrop of highly contrasting elements).

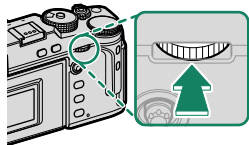
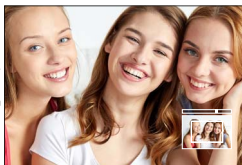
**Checking Focus**

To zoom in on the current focus area for precise focus, press the center of the rear command dial. Use the focus stick (focus lever) to choose another focus area. Press the center of the rear command dial again to cancel zoom.

*Normal display**Focus zoom*

- In focus mode **S**, zoom can be adjusted by rotating the rear command dial.
- The focus stick can be used to select the focus area while zoom is in effect.
- In focus mode **S**, select  **SINGLE POINT** for **AF MODE**.
- Focus zoom is not available in focus mode **C** or when  **AF/MF SETTING** > **PRE-AF** is on.
- Use  **BUTTON/DIAL SETTING** > **FUNCTION (Fn) SETTING** to change the function performed by the center of the rear command dial. You can also assign its default function to other controls ( 248).

## Manual Focus

Adjust focus manually.

- 1 Rotate the focus mode selector to M.

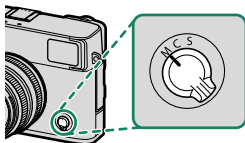

**MF** will appear in the display.



- 2 Focus manually using the lens focus ring. Rotate the ring left to reduce the focus distance, right to increase.

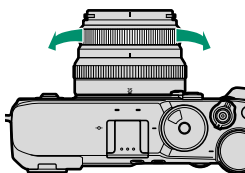

- 3 Take pictures.

- Use **BUTTON/DIAL SETTING > FOCUS RING** to reverse the direction of rotation of the focus ring.
- Regardless of the option selected, manual focus will be used when the lens is in manual focus mode.

### Quick Focus

- To use autofocus to focus on the subject in the selected focus area, press the button to which focus lock or **AF-ON** has been assigned (the size of the focus area can be chosen with the rear command dial).
- In manual focus mode, you can use this feature to quickly focus on a chosen subject using either single or continuous AF according to the option chosen for  **AF/MF SETTING > INSTANT AF SETTING**.



## Checking Focus

A variety of options are available for checking focus in manual focus mode.

### The Manual Focus Indicator

The manual focus indicator indicates how closely the focus distance matches the distance to the subject in the focus brackets. The white line indicates the distance to the subject in the focus area (in meters or feet according to the option selected for **SCREEN SET-UP > FOCUS SCALE UNITS** in the setup menu), the blue bar the depth of field, or in other words the distance in front of and behind the subject that appears to be in focus.

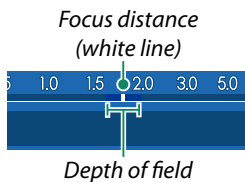
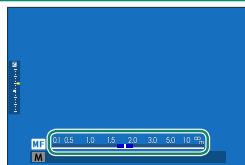

- If both **AF DISTANCE INDICATOR** and **MF DISTANCE INDICATOR** are selected in the **SCREEN SET-UP > DISP. CUSTOM SETTING** list, the manual focus indicator can also be viewed using the depth-of-field indicator in the standard display. Use the **DISP/BACK** button to display standard indicators.
- Use the **AF/MF SETTING > DEPTH-OF-FIELD SCALE** option to choose how depth of field is displayed. Choose **FILM FORMAT BASIS** to help you make practical assessments of depth of field for pictures that will be viewed as prints and the like, **PIXEL BASIS** to help you assess depth of field for pictures that will be viewed at high resolutions on computers or other electronic displays.

## Focus Zoom

If **ON** is selected for **AF/MF SETTING > FOCUS CHECK**, the camera will automatically zoom in on the selected focus area when the focus ring is rotated. Press the center of the rear command dial to exit zoom.

- Use the focus stick (focus lever) to choose another focus area.
- If **STANDARD** or **FOCUS PEAK HIGHLIGHT** is selected for **AF/MF SETTING > MF ASSIST**, zoom can be adjusted by rotating the rear command dial. Zoom cannot be adjusted when **DIGITAL SPLIT IMAGE** or **DIGITAL MICROPRISM** is selected.

## MF Assist

Use **AF/MF SETTING > MF ASSIST** to choose a focus check option.

- The **MF ASSIST** menu can be displayed by pressing and holding the center of the rear command dial.

The following options are available:

- **DIGITAL SPLIT IMAGE:** Displays a split image in the center of the frame. Frame the subject in the split-image area and rotate the focus ring until the four parts of the split image are correctly aligned.
- **DIGITAL MICROPRISM:** A grid pattern that emphasizes blur is displayed when the subject is out of focus, disappearing to be replaced by a sharp image when the subject is in focus.
- **FOCUS PEAK HIGHLIGHT:** Highlights high-contrast outlines. Rotate the focus ring until the subject is highlighted.

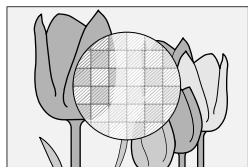
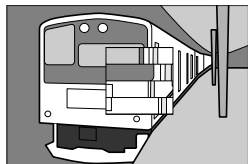

## Sensitivity

Adjust the camera's sensitivity to light.

Sensitivity can be set by lifting and rotating the sensitivity dial.

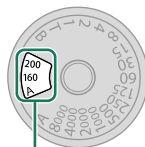
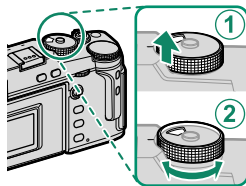

Sensitivity

Option	Description
<b>A</b> (auto)	Sensitivity is automatically adjusted in response to shooting conditions according to option chosen for <b>SHOOTING SETTING &gt; ISO AUTO SETTING</b> . Choose from <b>AUTO1</b> , <b>AUTO2</b> , and <b>AUTO3</b> .
<b>C</b> (command)	Rotate the front command dial to choose from values of from 80 to 51200. This range includes "extended" values of 80 to 125, 25600, and 51200. Note that "extended" values may reduce dynamic range or increase mottling.
<b>160–12800</b>	Adjust sensitivity manually. Selected value is shown in display.

### Adjusting Sensitivity

High values can be used to reduce blur when lighting is poor, while lower values allow slower shutter speeds or wider apertures in bright light; note, however, that mottling may appear in pictures taken at high sensitivities.

## Auto Sensitivity (A)

Use  **SHOOTING SETTING > ISO AUTO SETTING** to choose the base sensitivity, maximum sensitivity, and minimum shutter speed for the **A** position on the sensitivity dial. Settings for **AUTO1**, **AUTO2**, and **AUTO3** can be stored separately; the defaults are shown below.

Item	Options	Default		
		AUTO1	AUTO2	AUTO3
<b>DEFAULT SENSITIVITY</b>	160–12800	160		
<b>MAX. SENSITIVITY</b>	400–12800	800	1600	3200
<b>MIN. SHUTTER SPEED</b>	1/500–1/4 SEC, AUTO	1/60 SEC		

The camera automatically chooses a sensitivity between the default and maximum values; sensitivity is only raised above the default value if the shutter speed required for optimal exposure would be slower than the value selected for **MIN. SHUTTER SPEED**.





-  • If the value selected for **DEFAULT SENSITIVITY** is higher than that selected for **MAX. SENSITIVITY**, **DEFAULT SENSITIVITY** will be set to the value selected for **MAX. SENSITIVITY**.
- The camera may select shutter speeds slower than **MIN. SHUTTER SPEED** if pictures would still be underexposed at the value selected for **MAX. SENSITIVITY**.
- If **AUTO** is selected for **MIN. SHUTTER SPEED**, the camera will automatically choose a minimum shutter speed approximately equal to the inverse of the lens' focal length, in seconds (for example, if the lens has a focal length of 50 mm, the camera will choose a minimum shutter speed in the neighborhood of 1/50 s). The minimum shutter speed is not affected by the option selected for image stabilization.

## Metering

Choose how the camera meters exposure.

**SHOOTING SETTING > PHOTOMETRY** offers a choice of the following metering options:

**!** The selected option will only take effect when **AF/MF SETTING > FACE/EYE DETECTION SETTING** is **OFF**.

Mode	Description
 (multi)	The camera instantly determines exposure based on an analysis of composition, color, and brightness distribution. Recommended in most situations.
 (center-weighted)	The camera meters the entire frame but assigns the greatest weight to the area at the center.
 (spot)	The camera meters lighting conditions in an area at the center of the frame equivalent to 2% of the total. Recommended with backlit subjects and in other cases in which the background is much brighter or darker than the main subject.
 (average)	Exposure is set to the average for the entire frame. Provides consistent exposure across multiple shots with the same lighting, and is particularly effective for landscapes and portraits of subjects dressed in black or white.

## Exposure Compensation

Adjust exposure.

Rotate the exposure compensation dial.

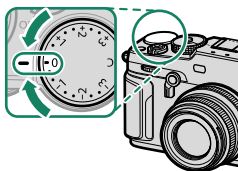

- The amount of compensation available varies with the shooting mode.
- Exposure compensation can be previewed in the shooting display, although the display may not accurately reflect its effects if:
  - the exposure compensation amount exceeds  $\pm 3$  EV,
  - $\text{f}200$  **200%** or  $\text{f}400$  **400%** is selected for **DYNAMIC RANGE**, or
  - **STRONG** or **WEAK** is selected for **D RANGE PRIORITY**.

Exposure compensation can still be previewed in the viewfinder or LCD monitor by pressing the shutter button halfway. In movie mode, the display may not accurately reflect the effects of exposure compensation when  $\text{f}200$  **200%** or  $\text{f}400$  **400%** is selected for **DYNAMIC RANGE** or **ON** is selected for **F-Log RECORDING**. An accurate preview can be obtained by selecting mode **M** and adjusting exposure directly.

## C (Custom)

When the exposure compensation dial is rotated to **C**, exposure compensation can be adjusted by rotating the front command dial.

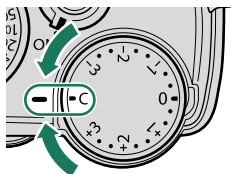

- The front command dial can be used to set exposure compensation to values between  $-5$  and  $+5$  EV.
- The role played by the front command dial can be selected by pressing the **Fn2** button.

## Focus/Exposure Lock

Focus and exposure lock when the shutter button is pressed halfway.

- 1 Position the subject in the focus frame and press the shutter button halfway to lock focus and exposure. Focus and exposure will remain locked while the shutter button is pressed halfway (AF/AE lock).

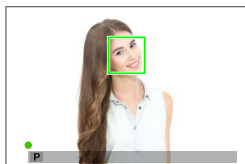

- 2 Press the button all the way down.



Focus lock using the shutter button is only available when **ON** is selected for **☑️ BUTTON/DIAL SETTING > SHUTTER AF, SHUTTER AE**.



## Other Controls

Pressing the **AE-L/AF-L** button locks both focus and exposure.

- While the assigned control is pressed, pressing the shutter button halfway will not end the lock.
- If **AE&AF ON/OFF SWITCH** is selected for **FUNCTION (Fn) SETTING > AE/AF-LOCK MODE**, the lock can only be ended by pressing the control a second time.

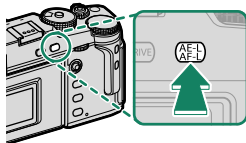

**AE-L/AF-L button**  
(AE/AF lock)

- The **AE-L/AF-L** button can be assigned other roles using **FUNCTION (Fn) SETTING > FUNCTION (Fn) SETTING**. Exposure and focus lock can also be assigned to other function buttons (📖 248).
- Exposure and focus lock can be performed separately by assigning them to different function buttons.

## Bracketing

Automatically vary settings over a series of pictures.

- 1 Press the **DRIVE** button and select the desired bracketing option in the drive-mode menu.

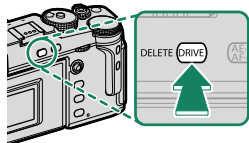

- 2 Take photographs.

### ISO BKT

Select a bracketing amount ( $\pm 1/3$ ,  $\pm 2/3$ , or  $\pm 1$ ) in the drive mode display. Each time the shutter is released, the camera will take a picture at the current sensitivity and process it to create two additional copies, one with sensitivity raised and the other with sensitivity lowered by the selected amount.

### WB WHITE BALANCE BKT

Select a bracketing amount ( $\pm 1$ ,  $\pm 2$ , or  $\pm 3$ ) in the drive mode display. Each time the shutter is released, the camera takes one shot and processes it to create three copies: one at the current white balanced setting, one with fine-tuning increased by the selected amount, and another with fine-tuning decreased by the selected amount.

## BKT BKT

### AE BKT

Use  **SHOOTING SETTING** > **AE BKT SETTING** to choose the bracketing amount, bracketing order, and number of shots. Each time the shutter button is pressed, the camera will take the specified number of shots: one using the metered value for exposure and the others over- or under-exposed by multiples of the selected bracketing amount.

 Regardless of the bracketing amount, exposure will not exceed the limits of the exposure metering system.

### FILM SIMULATION BKT

Each time the shutter is released, the camera takes one shot and processes it to create copies with different film simulation settings, chosen using  **SHOOTING SETTING** > **FILM SIMULATION BKT**.

### DYNAMIC RANGE BKT

Each time the shutter button is pressed, the camera takes three shots with different dynamic ranges: 100% for the first, 200% for the second, and 400% for the third.

 While dynamic range bracketing is in effect, sensitivity will be restricted to a minimum of ISO 640; the sensitivity previously in effect is restored when bracketing ends.

## FOCUS BKT

Each time the shutter button is pressed, the camera takes a series of photos, varying focus with each shot. The **SHOOTING SETTING > FOCUS BKT SETTING** item offers a choice of **MANUAL** and **AUTO** bracketing.

- Do not adjust zoom during shooting.
- Use of a tripod is recommended.

### MANUAL

In **MANUAL** mode, you choose the following.

Option	Description
<b>FRAMES</b>	Choose the number of shots.
<b>STEP</b>	Choose the amount focus changes with each shot.
<b>INTERVAL</b>	Choose the interval between shots.

### AUTO

In **AUTO** mode, the camera calculates **FRAMES** and **STEP** automatically.

- Select **SHOOTING SETTING** in the shooting menu, highlight **FOCUS BKT SETTING**, and press **MENU/OK**.
- Select **AUTO** and choose an **INTERVAL**.  
The view through the lens will be displayed.
- Focus on the nearest end of the subject and press **MENU/OK**.  
The selected focus distance appears as **A** on the focus distance indicator.

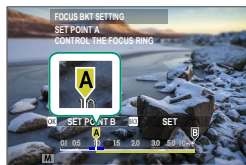

- The same focus range can be chosen by focusing on the farthest end of the subject first.

- 4 Focus on the farthest end of the subject and press **DISP/BACK**. The selected focus distance (**B**) and focus range (**A** to **B**) appear on the focus distance indicator.

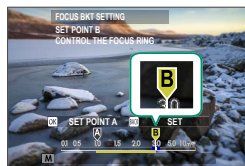

 Instead of pressing the **DISP/BACK** button, you can press **MENU/OK** and select **A** again.

- 5 Take photographs. The camera will calculate values for **FRAMES** and **STEP** automatically. The number of frames will appear in the display.

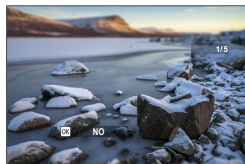



## Continuous Shooting (Burst Mode)

Capture motion in a series of pictures.

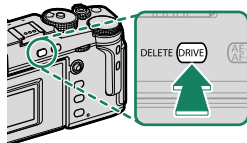
- 1 Press the **DRIVE** button and select **CONTINUOUS**  or **CONTINUOUS** in the drive-mode menu.



 Before taking pictures in **CONTINUOUS**  mode, select **ES ELECTRONIC SHUTTER** for **SHOOTING SETTING > SHUTTER TYPE**.

- 2 Choose the frame advance rate and press the shutter button to start shooting.

Shooting ends when the shutter button is released or the memory card is full.

-  If file numbering reaches 9999 before shooting is complete, the remaining pictures will be recorded to a new folder.
- Shooting ends when the memory card is full; the camera will record all photos shot to that point. Burst shooting may not begin if the space available on the memory card is insufficient.
- Frame rates may slow as more shots are taken.
- Frame rate varies with the scene, shutter speed, sensitivity, and focus mode.
- Depending on shooting conditions, frame rates may slow or the flash may not fire.
- Recording times may increase during burst shooting.

### Exposure

To vary exposure with each shot, select **OFF** for **BUTTON/DIAL SETTING > SHUTTER AE**.

-  Depending on such factors as aperture, sensitivity, and exposure compensation, exposure may not be adjusted automatically.

## HDR

Each time the shutter button is pressed, the camera takes three shots, varying exposure each time, and combines them into a single picture. The resulting photograph preserves details in highlights and shadows.

- 1 Press the **DRIVE** button and select **HDR** in the drive-mode menu.

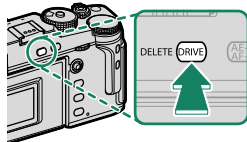



- 2 Choose the amount the brightnesses of the exposures vary.

Option	Description
<b>HDR AUTO</b>	Dynamic range is automatically set to a value of from 200% to 800%.
<b>HDR200</b>	Dynamic range is set to 200%.
<b>HDR400</b>	Dynamic range is set to 400%.
<b>HDR800</b>	Dynamic range is set to 800%.
<b>HDR PLUS</b>	Camera settings are adjusted for maximum variation in dynamic range.

- 3 Take photographs.  
The camera will create a combined image.

-  Keep the camera steady.
- The desired results may not be achieved if the subject moves or the composition or lighting changes during shooting.
- The picture will be cropped a very small amount and the resolution will drop slightly.
- Mottling may appear in pictures taken at higher values. Choose a value according to the scene.
- "Extended" sensitivity values are not supported.
- Depending on the options selected for HDR and sensitivity, pictures may not be taken at the selected shutter speed.
- The flash does not fire.

 HDR images are indicated by a  icon during playback.



## Multiple Exposures

Create a photograph that combines multiple exposures.

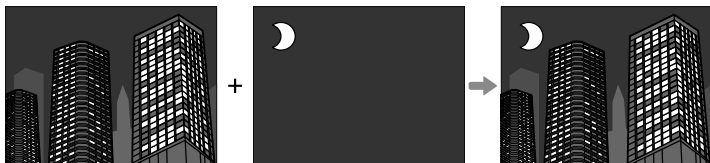

- 1 Press the **DRIVE** button and select **MULTIPLE EXPOSURE** in the drive-mode menu.

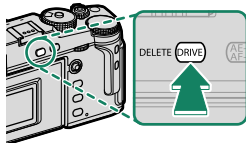

- 2 Take the first shot.
- 3 Press **MENU/OK**. The first shot will be shown superimposed on the view through the lens and you will be prompted to take the second shot.

- To return to the previous step and retake the first shot, press the focus stick (focus lever) left.
- To save the first shot and exit without creating a multiple exposure, press **DISP/BACK**.



- 4 Take the second shot, using the first frame as a guide.



**5** Press **MENU/OK**.

The combined exposures will be displayed as a guide to composing the next shot.

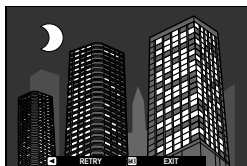

- To return to the previous step and retake the second shot, press the focus stick left.
- To end shooting and create a multiple exposure from the shots taken to this point, press **DISP/BACK**.

**6** Make additional exposures.

Each photograph can contain up to nine exposures.

**7** Press **DISP/BACK** to end shooting.

The camera will create the combined image and multiple exposure shooting will end.



Multiple exposures cannot be recorded via tethered shooting (📖 235).



Use **SHOOTING SETTING > MULTIPLE EXPOSURE CTRL** to choose how the exposures are combined.

## Advanced Filters

Take photos with filter effects.



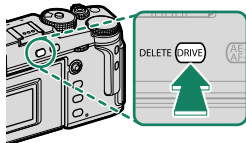









- 1 Press the **DRIVE** button and select **ADVANCED FILTER** in the drive-mode menu.



- 2 Choose a filter.
- 3 Take photographs.

## Advanced Filter Options

Choose from the following filters:

Filter	Description
 <b>TOY CAMERA</b>	Choose for a retro toy camera effect.
 <b>MINIATURE</b>	The tops and bottoms of pictures are blurred for a diorama effect.
 <b>POP COLOR</b>	Create high-contrast images with saturated colors.
 <b>HIGH-KEY</b>	Create bright, low-contrast images.
 <b>LOW-KEY</b>	Create uniformly dark tones with few areas of emphasized highlights.
 <b>DYNAMIC TONE</b>	Dynamic tone expression is used for a fantasy effect.
 <b>SOFT FOCUS</b>	Create a look that is evenly soft throughout the whole image.
 <b>PARTIAL COLOR (RED)</b>	Areas of the image that are the selected color are recorded in that color. All other areas of the image are recorded in black-and-white.
 <b>PARTIAL COLOR (ORANGE)</b>	
 <b>PARTIAL COLOR (YELLOW)</b>	
 <b>PARTIAL COLOR (GREEN)</b>	
 <b>PARTIAL COLOR (BLUE)</b>	
 <b>PARTIAL COLOR (PURPLE)</b>	

 Depending on the subject and camera settings, images may in some cases be grainy or vary in brightness or hue.

# 6

## The Shooting Menus

## IMAGE QUALITY SETTING

Adjust image quality settings.

To display image quality settings, press **MENU/OK** in the shooting display and select the **IQ** (IMAGE QUALITY SETTING) tab.



 The options available vary with the shooting mode selected.

## IMAGE SIZE

Choose the size and aspect ratio at which still pictures are recorded.

Option	Image size
<b>L</b> 3:2	6240 × 4160
<b>L</b> 16:9	6240 × 3512

Option	Image size
<b>L</b> 1:1	4160 × 4160

Option	Image size
<b>M</b> 3:2	4416 × 2944
<b>M</b> 16:9	4416 × 2488

Option	Image size
<b>M</b> 1:1	2944 × 2944

Option	Image size
<b>S</b> 3:2	3120 × 2080
<b>S</b> 16:9	3120 × 1760

Option	Image size
<b>S</b> 1:1	2080 × 2080

The following options are available in **SPORTS FINDER MODE** and when **1.25X CROP** is selected in burst mode:

Option	Image size
<b>M</b> 3:2	4992 × 3328
<b>M</b> 16:9	4992 × 2808

Option	Image size
<b>M</b> 1:1	3328 × 3328

 **IMAGE SIZE** is not reset when the camera is turned off or another shooting mode is selected.

## IMAGE QUALITY

Choose a file format and compression ratio.

Option	Description
<b>FINE</b>	Low compression ratios are used for higher-quality images.
<b>NORMAL</b>	Higher compression ratios are used to increase the number of images that can be stored.
<b>FINE + RAW</b>	Record both RAW and fine-quality JPEG images.
<b>NORMAL + RAW</b>	Record both RAW and normal-quality JPEG images.
<b>RAW</b>	Record RAW images only.

### The Function Buttons

To toggle RAW image quality on or off for a single shot, assign **RAW** to a function button (☰ 248). Press the button once to select the option in the right column, again to return to the original setting (left column).

Option currently selected for IMAGE QUALITY	Option selected by pressing function button to which RAW is assigned
<b>FINE</b>	<b>FINE + RAW</b>
<b>NORMAL</b>	<b>NORMAL + RAW</b>
<b>FINE + RAW</b>	<b>FINE</b>
<b>NORMAL + RAW</b>	<b>NORMAL</b>
<b>RAW</b>	<b>FINE</b>









## RAW RECORDING

Choose whether to compress RAW images.





Option	Description
<b>UNCOMPRESSED</b>	RAW images are not compressed.
<b>LOSSLESS COMPRESSED</b>	RAW images are compressed using a reversible algorithm that reduces file size with no loss of image data. The images can be viewed in Capture One Express Fujifilm (📖 289), RAW FILE CONVERTER EX (📖 289), FUJIFILM X RAW STUDIO (📖 290), or other software that supports “lossless” RAW compression.

## FILM SIMULATION

Simulate the effects of different kinds of film, including black-and-white (with or without color filters). Choose a palette according to your subject and creative intent.

Option	Description
 <b>PROVIA/STANDARD</b>	Ideal for a wide range of subjects.
 <b>Velvia/VIVID</b>	Vibrant reproduction, ideal for landscape and nature.
 <b>ASTIA/SOFT</b>	Softer color and contrast for a more subdued look.
 <b>CLASSIC CHROME</b>	Soft color and enhanced shadow contrast for a calm look.
 <b>PRO Neg. Hi</b>	Ideal for portrait with slightly enhanced contrast.
 <b>PRO Neg. Std</b>	Ideal for portrait with soft gradations and skin tones.
 <b>CLASSIC Neg.</b>	Enhanced color with hard tonality to increase image depth.
 <b>ETERNA/CINEMA</b>	Soft color and rich shadow tone suitable for film look movie.



Option	Description
 <b>ACROS</b>	<p>Shoot in Black and White In rich details with sharpness. Available with yellow (<b>Ye</b>), red (<b>R</b>), and green (<b>G</b>) filters, which deepen shades of gray corresponding to hues complementary to the selected color.</p> <ul style="list-style-type: none"> <li>• <b>ACROS+Ye FILTER:</b> Slightly enhances contrast and darkens skies.</li> <li>• <b>ACROS+R FILTER:</b> Enhances contrast and darkens skies considerably.</li> <li>• <b>ACROS+G FILTER:</b> Produces pleasing skin tones in portrait.</li> </ul>
 <b>MONOCHROME</b>	<p>Shoots in black and white. Available with yellow (<b>Ye</b>), red (<b>R</b>), and green (<b>G</b>) filters, which deepen shades of gray corresponding to hues complementary to the selected color.</p> <ul style="list-style-type: none"> <li>• <b>MONOCHROME+Ye FILTER:</b> Slightly enhances contrast and darkens skies.</li> <li>• <b>MONOCHROME+R FILTER:</b> Enhances contrast and darkens skies considerably.</li> <li>• <b>MONOCHROME+G FILTER:</b> Produces pleasing skin tones in portrait.</li> </ul>
 <b>SEPIA</b>	<p>Shoots in sepia tone.</p>
 <ul style="list-style-type: none"> <li>• Film simulation options can be combined with tone and sharpness settings.</li> <li>• Film simulation settings can also be accessed via shortcuts (📖 240).</li> <li>• For more information, visit: <a href="http://fujifilm-x.com/en/x-stories/the-world-of-film-simulation-episode-1/">http://fujifilm-x.com/en/x-stories/the-world-of-film-simulation-episode-1/</a></li> </ul>	

## MONOCHROMATIC COLOR

Add a reddish or bluish tinge (warm or cool color cast) to the **A** ACROS and **B** MONOCHROME monochrome film simulations. Color can be adjusted on the **WARM-COOL** and **G (Green)-M (Magenta)** axes.

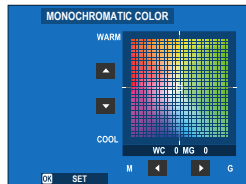

## GRAIN EFFECT

Add a film grain effect.

### ROUGHNESS

Option	Description
<b>STRONG</b>	Choose for rougher grains.
<b>WEAK</b>	Choose for smoother grains.
<b>OFF</b>	Turn the effect off.

### SIZE

Option	Description
<b>LARGE</b>	Choose for coarser grains.
<b>SMALL</b>	Choose for finer grains.

## COLOR CHROME EFFECT

Increase the range of tones available for rendering colors that tend to be highly saturated, such as reds, yellows, and greens.

Option	Description
<b>STRONG</b>	Choose for a strong effect.
<b>WEAK</b>	Choose for a weak effect.
<b>OFF</b>	Turn the effect off.









## COLOR CHROME FX BLUE

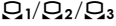

Increase the range of tones available for rendering blues.

Option	Description
<b>STRONG</b>	Choose for a strong effect.
<b>WEAK</b>	Choose for a weak effect.
<b>OFF</b>	Turn the effect off.

## WHITE BALANCE

For natural colors, choose a white balance option that matches the light source.

Option	Description
<b>AUTO</b>	White balance is adjusted automatically.
	Measure a value for white balance.
	Choose a color temperature.
	For subjects in direct sunlight.
	For subjects in the shade.
	Use under “daylight” fluorescent lights.
	Use under “warm white” fluorescent lights.
	Use under “cool white” fluorescent lights.
	Use under incandescent lighting.
	Reduces the blue cast typically associated with underwater lighting.

-  In conditions in which **AUTO** fails to produce the desired results—for example, under certain types of lighting or in close-ups of portrait subjects—use custom white balance or choose a white balance option suited to the light source.
- White balance is adjusted for flash lighting only in **AUTO** and  modes. Turn the flash off using other white balance options.
- White balance options can also be accessed via shortcuts ( 240).

## Fine-Tuning White Balance

Pressing **MENU/OK** after selecting a white balance option displays a fine-tuning dialog; use the focus stick (focus lever) to fine-tune white balance.

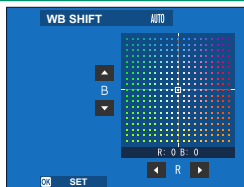

- To exit without fine-tuning white balance, press **DISP/BACK** after selecting a white balance option.
- The focus stick (focus lever) does not tilt diagonally.

## Custom White Balance

Choose  $\mathcal{Q}_1$ ,  $\mathcal{Q}_2$ , or  $\mathcal{Q}_3$  to adjust white balance for unusual lighting conditions using a white object as a reference (colored objects can also be used to lend photos a color cast). A white balance target will be displayed; position and size the target so that it is filled by the reference object and press the shutter button all the way down to measure white balance (to select the most recent custom value and exit without measuring white balance, press **DISP/BACK**, or press **MENU/OK** to select the most recent value and display the fine-tuning dialog).

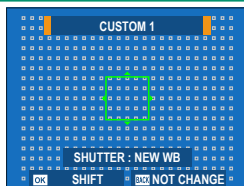

- If **"COMPLETED!"** is displayed, press **MENU/OK** to set white balance to the measured value.
- If **"UNDER"** is displayed, raise exposure compensation and try again.
- If **"OVER"** is displayed, lower exposure compensation and try again.

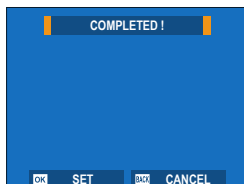

## **K**: Color Temperature

Changing the color temperature changes overall hue.

 Color temperature can be adjusted to make pictures “warmer” or “colder” or deliberately produce colors that differ radically from those in real life.

- 1 Select **K** in the white balance menu. A list of color temperatures will be displayed.

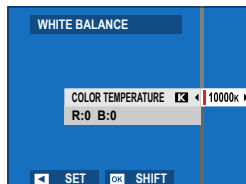

- 2 Highlight a color temperature using the focus stick (focus lever) and press **MENU/OK**. A fine-tuning dialog will be displayed.

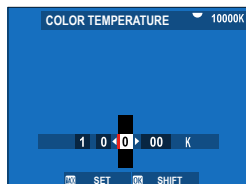

-  You can also adjust color temperature in increments of 10 K by rotating the rear command dial.
- To exit without fine-tuning white balance, press **DISP/BACK** after choosing a color temperature.

- 3 Highlight a fine-tuning amount using the focus stick.
- 4 Press **MENU/OK**. The changes will be applied. The selected color temperature will appear in the display.

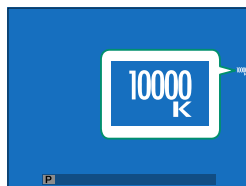

## Color Temperature

Color temperature is an objective measure of the color of a light source, expressed in Kelvin (K). Light sources with a color temperature close to that of direct sunlight appear white; light sources with a lower color temperature have a yellow or red cast, while those with a higher color temperature are tinged with blue.

## DYNAMIC RANGE

Control contrast. Choose lower values to increase contrast when shooting indoors or under overcast skies, higher values to reduce loss of detail in highlights when photographing high-contrast scenes. Higher values are recommended for scenes that include both sunlight and deep shade, for such high-contrast subjects as sunlight on water, brightly-lit autumn leaves, and portraits taken against a blue sky, and for white objects or people wearing white.

### Options

**AUTO**

**100 100%**

**200 200%**

**400 400%**



Mottling may appear in pictures taken at higher values. Choose a value according to the scene.



- If **AUTO** is selected, the camera will automatically choose either **100 100%** or **200 200%** according to the subject and shooting conditions. Shutter speed and aperture will be displayed when the shutter button is pressed halfway.
- 200 200%** is available at sensitivities of from ISO 320 to ISO 12800, **400 400%** at sensitivities of from ISO 640 to 12800.

## D RANGE PRIORITY

Reduce loss of detail in highlights and shadows for natural-looking results when photographing high-contrast scenes.

Option	Description
<b>AUTO</b>	Contrast is adjusted automatically in response to lighting conditions.
<b>STRONG</b>	Adjust dynamic range by a large amount for very high-contrast scenes.
<b>WEAK</b>	Adjust dynamic range by a smaller amount for moderately high-contrast scenes.
<b>OFF</b>	Contrast reduction off.

- **WEAK** is available at sensitivities of from ISO 320 to ISO 12800, **STRONG** at sensitivities of from ISO 640 to 12800.
- When an option other than **OFF** is selected, **HIGHLIGHT TONE**, **SHADOW TONE**, and **DYNAMIC RANGE** will be adjusted automatically; if you wish to adjust these settings manually, choose **OFF**.

## TONE CURVE

With reference to a tone curve, use the focus stick (focus lever) to adjust the appearance of highlights or shadows, making them harsher or softer. Choose higher values to make shadows and highlights harsher, lower values to make them softer.

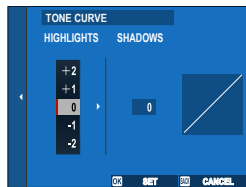

Options						
-2	-1	0	+1	+2	+3	+4



**COLOR**

Adjust color density. Choose higher values to increase saturation, lower values to reduce it.

Options								
-4	-3	-2	-1	0	+1	+2	+3	+4

**SHARPNESS**

Sharpen or soften outlines. Choose higher values for sharper outlines, lower values for softer outlines.

Options								
-4	-3	-2	-1	0	+1	+2	+3	+4

**NOISE REDUCTION**

Reduce noise in pictures taken at high sensitivities. Choose higher values to reduce noise and smooth outlines, lower values to leave outlines visible.

Options								
-4	-3	-2	-1	0	+1	+2	+3	+4

## CLARITY

Increase definition while altering tones in highlights and shadows as little as possible. Choose higher values for increased definition, lower values for a softer effect.

Options										
-5	-4	-3	-2	-1	0	+1	+2	+3	+4	+5

## LONG EXPOSURE NR

Select **ON** to reduce mottling in long time-exposures.

Options	
ON	OFF

## LENS MODULATION OPTIMIZER

Select **ON** to improve definition by adjusting for diffraction and the slight loss of focus at the periphery of the lens.

Options	
ON	OFF

## COLOR SPACE

Choose the gamut of colors available for color reproduction.

Option	Description
sRGB	Recommended in most situations.
Adobe RGB	For commercial printing.

## PIXEL MAPPING

Use this option if you notice bright spots in your pictures.

- 1 Press **MENU/OK** in the shooting display and select the  **IMAGE QUALITY SETTING** tab.
- 2 Highlight **PIXEL MAPPING** and press **MENU/OK** to perform pixel mapping.

-  • Results are not guaranteed.
- Be sure the battery is fully charged before beginning pixel mapping.
  - Pixel mapping is not available when the camera temperature is elevated.
  - Processing may take a few seconds.

## SELECT CUSTOM SETTING

Settings can be recalled from any of the seven custom settings banks.

Banks			
CUSTOM 1	CUSTOM 2	CUSTOM 3	CUSTOM 4
	CUSTOM 5	CUSTOM 6	CUSTOM 7

## EDIT/SAVE CUSTOM SETTING

Save up to 7 sets of custom camera settings for commonly-encountered situations. Saved settings can be recalled using **Q** **IMAGE QUALITY SETTING** > **SELECT CUSTOM SETTING**.

- 1 Select **Q** **IMAGE QUALITY SETTING** in the shooting menu, then highlight **EDIT/SAVE CUSTOM SETTING** and press **MENU/OK**.
- 2 Highlight a custom settings bank and press **MENU/OK** to select.

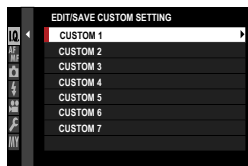

- 3 Highlight **EDIT** and press **MENU/OK**. A list of shooting menu options will be displayed.



- To store current camera settings in the selected bank, highlight **SAVE CURRENT SETTINGS** and press **MENU/OK**.
- To restore default settings for the current bank, select **RESET**.
- Banks can be renamed using **EDIT CUSTOM NAME**.

- 4 Highlight an item you wish to store in the custom settings bank and press **MENU/OK**. Adjust settings for the selected item.

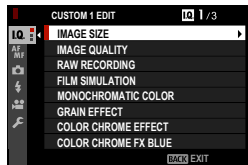

- 5 Press **MENU/OK** to save changes to the selected item and return to the menu item list.  
Adjust additional items as desired.
- 6 Pressing **DISP/BACK** in the menu item list displays a confirmation dialog. Highlight **OK** and press **MENU/OK** to save the settings to the selected bank.

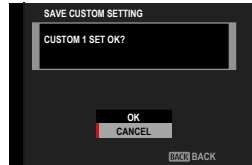

## AF/MF SETTING

Adjust focus settings.

To display focus settings, press **MENU/OK** in the shooting display and select the **AF/MF** (AF/MF SETTING) tab.

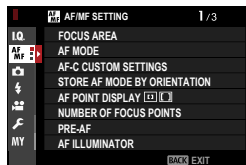









 The options available vary with the shooting mode selected.

### FOCUS AREA

Choose the focus area for autofocus, manual focus, and focus zoom.

## AF MODE

Choose the AF mode for focus modes **S** and **C**.

Option	Description
 <b>SINGLE POINT</b>	The camera focuses on the subject in the selected focus point. The number of focus points available can be selected using  <b>AF/MF SETTING &gt; NUMBER OF FOCUS POINTS</b> . Use for pin-point focus on a selected subject.
 <b>ZONE</b>	The camera focuses on the subject in the selected focus zone. Focus zones include multiple focus points, making it easier to focus on subjects that are in motion.
 <b>WIDE/TRACKING</b>	<ul style="list-style-type: none"> <li>• In focus mode <b>S</b>, the camera automatically focuses on high-contrast subjects; the areas in focus are shown in the display.</li> <li>• In focus mode <b>C</b>, the camera tracks focus on the subject in the selected focus point while the shutter button is pressed halfway.</li> </ul> The camera may be unable to focus on small objects or subjects that are moving rapidly.
 <b>ALL</b>	Rotate the rear command dial in the focus-point selection display (📖 72, 73) to cycle through AF modes in the following order:  <b>SINGLE POINT</b> ,  <b>ZONE</b> , and  <b>WIDE/TRACKING</b> .

## AF-C CUSTOM SETTINGS

Select focus-tracking options for focus mode C. Choose from Sets 1–5 according to your subject or select Set 6 for custom focus-tracking options.

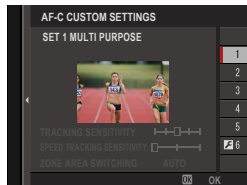

Option	Description
<b>SET 1 MULTI PURPOSE</b>	A standard tracking option that works well with the typical range of moving subjects.
<b>SET 2 IGNORE OBSTACLES &amp; CONTINUE TO TRACK SUBJECT</b>	The focus system attempts to track the chosen subject. Choose with subjects that are hard to keep in the focus area or if other objects are likely to enter the focus area with the subject.
<b>SET 3 FOR ACCELERATING/ DECELERATING SUBJECT</b>	The focus system attempts to compensate for subject acceleration or deceleration. Choose for subjects prone to rapid changes in velocity.
<b>SET 4 FOR SUDDENLY APPEARING SUBJECT</b>	The focus system attempts to focus quickly on subjects entering the focus area. Choose for subjects that appear abruptly or when rapidly switching subjects.
<b>SET 5 FOR ERRATICALLY MOVING &amp; ACCEL./DECEL. SUBJECT</b>	Choose for hard-to-track subjects prone not only to sudden changes in velocity but also to large movements front to back and left to right.
<b>SET 6 CUSTOM</b>	Adjust <b>TRACKING SENSITIVITY</b> , <b>SPEED TRACKING SENSITIVITY</b> , and <b>ZONE AREA SWITCHING</b> to suit your preferences based on the values for Sets 1–5 (☰ 117, 119).



## Focus Tracking Options

The individual parameters that are part of a focus tracking set are described below.

### TRACKING SENSITIVITY

This parameter determines how long the camera waits to switch focus when an object enters the focus area behind or in front of the current subject. The higher the value, the longer the camera will wait.

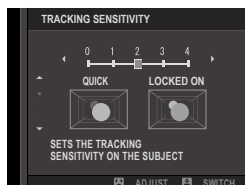

#### Options

0 | 1 | 2 | 3 | 4

- The higher the value, the longer it takes the camera to refocus when you attempt to switch subjects.
- The lower the value, the more likely the camera is to switch focus from your subject to other objects in the focus area.

### SPEED TRACKING SENSITIVITY

This parameter determines how sensitive the tracking system is to changes in subject velocity. The higher the value, the greater the precision with which the system attempts to respond to sudden movement.

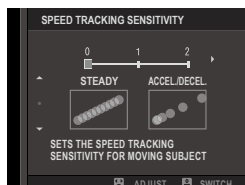

#### Options

0 | 1 | 2

- The higher the value, the more difficulty the camera will have focusing in situations in which autofocus does not perform well, such as when the subject is highly reflective or low in contrast.

## ZONE AREA SWITCHING

This parameter determines the focus area given priority in zone AF.

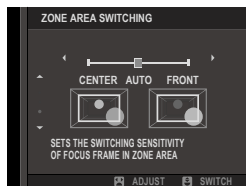

Option	Description
<b>FRONT</b>	Zone AF assigns priority to the subjects closest to the camera.
<b>AUTO</b>	The camera locks focus on the subject at the center of the zone and then switches focus areas as necessary to track it.
<b>CENTER</b>	Zone AF assigns priority to subjects in the center of the zone.

! This option takes effect only when **☐ ZONE** is selected for AF mode.

### Set Values

Parameter values for the different sets are listed below.

	TRACKING SENSITIVITY	SPEED TRACKING SENSITIVITY	ZONE AREA SWITCHING
<b>SET 1</b>	2	0	AUTO
<b>SET 2</b>	3	0	CENTER
<b>SET 3</b>	2	2	AUTO
<b>SET 4</b>	0	1	FRONT
<b>SET 5</b>	3	2	AUTO

## Custom Focus Tracking Options

Follow the steps below to adjust settings for Set 6.

- 1 Select **AF-C CUSTOM SETTINGS > SET 6 CUSTOM**.

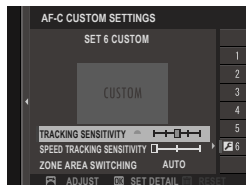

- 2 Highlight items using the focus stick (focus lever) and rotate the front command dial to change. To reset settings to their original values, press the **DRIVE** button.
- 3 Press **DISP/BACK** when settings are complete.

## STORE AF MODE BY ORIENTATION

Choose whether the focus mode and focus area used when the camera is in portrait orientation are stored separately from those used when the camera is in landscape orientation.

Option	Description
<b>OFF</b>	The same settings are used in both orientations.
<b>FOCUS AREA ONLY</b>	The focus area for each orientation can be selected separately.
<b>ON</b>	The focus mode and focus area can be selected separately.

## AF POINT DISPLAY

Choose whether individual focus frames are displayed when **ZONE** or **WIDE/TRACKING** is selected for **AF/MF SETTING > AF MODE**.

Options	
<b>ON</b>	<b>OFF</b>

## NUMBER OF FOCUS POINTS

Choose the number of focus points available for focus-point selection in manual focus mode or when **SINGLE POINT** is selected for **AF MODE**.

Option	Description
<b>117 POINTS</b> (9 × 13)	Choose from 117 focus points arranged in a 9- by 13-point grid.
<b>425 POINTS</b> (17 × 25)	Choose from 425 focus points arranged in a 17- by 25-point grid.

## PRE-AF

If **ON** is selected, the camera will continue to adjust focus even when the shutter button is not pressed halfway. The camera adjusts focus continuously, allowing it to focus faster when the shutter button is pressed halfway. Choosing this option helps prevent missed shots.

Options	
<b>ON</b>	<b>OFF</b>

 Choosing **ON** increases the drain on the battery.

## AF ILLUMINATOR

If **ON** is selected, the AF-assist illuminator will light to assist autofocus.

Options	
<b>ON</b>	<b>OFF</b>

-  • The camera may be unable to focus using the AF-assist illuminator in some cases.
- If the camera is unable to focus, try increasing the distance to the subject.
  - Avoid shining the AF-assist illuminator directly into your subject's eyes.



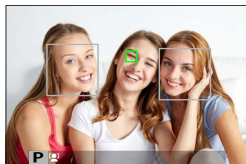

## FACE/EYE DETECTION SETTING

Intelligent Face Detection sets focus and exposure for human faces anywhere in the frame, preventing the camera from focusing on the background in group portraits. Choose for shots that emphasize portrait subjects. You can also choose whether the camera detects and focuses on either the left or right eye when Intelligent Face Detection is on.



Option	Description
<b>FACE DETECTION ON</b>	Adjust settings for Intelligent Face Detection. You can also adjust eye detection settings. <ul style="list-style-type: none"><li>• <b>EYE OFF:</b> Intelligent Face Detection only.</li><li>• <b>EYE AUTO:</b> The camera automatically chooses which eye to focus on when a face is detected.</li><li>• <b>RIGHT EYE PRIORITY:</b> The camera focuses on the right eye of subjects detected using Intelligent Face Detection.</li><li>• <b>LEFT EYE PRIORITY:</b> The camera focuses on the left eye of subjects detected using Intelligent Face Detection.</li></ul>
<b>OFF</b>	Intelligent Face Detection and eye priority off.

- If the subject moves as the shutter button is pressed, the face may not be in the area indicated by the green border when the picture is taken.
- In some modes, the camera may set exposure for the frame as a whole rather than the portrait subject.

- The face selected by the camera is indicated by a green border. Any other faces detected by the camera are indicated by gray borders. To have the camera focus on a different subject, tap inside the gray border. The  icon will change from white to green.
- You can also switch subjects by pressing the function button to which  **FACE SELECT**  is assigned and then using the focus stick (focus lever) ( 218).
- To switch from face detection to manual focus-area selection, press the center of the focus stick (focus lever). Press again to re-enable face detection.
- If the selected subject leaves the frame, the camera will wait a set time for its return and consequently the green frame may sometimes appear in locations where no face is seen.
- You cannot switch subjects during burst photography.
- Depending on shooting conditions, face selection may be suspended at the close of burst shooting.
- Faces can be detected with the camera in vertical or horizontal orientation.
- If the camera is unable to detect the subject's eyes because they are hidden by hair, glasses, or other objects, the camera will instead focus on faces.
- Face/eye detection options can also be accessed via shortcuts ( 240).

## AF+MF

If **ON** is selected in focus mode **S** and focus has been locked (whether by pressing the shutter button halfway or by other means), focus lock can be ended and focus adjusted manually by rotating the focus ring.

Options	
ON	OFF

-  Lenses with a focus distance indicator must be set to manual focus mode (MF) before this option can be used. Selecting MF disables the focus distance indicator.
- If the lens is equipped with a focus distance indicator, set the focus ring to the center, as the camera may fail to focus if the ring is set to infinity or the minimum focus distance.

 **STANDARD** and **FOCUS PEAK HIGHLIGHT** MF assist options can be selected using **MF ASSIST**.

### AF + MF Focus Zoom

When **ON** is selected for  **AF/MF SETTING** > **FOCUS CHECK** and **SINGLE POINT** selected for **AF MODE**, focus zoom can be used to zoom in on the selected focus area. The zoom ratio can be selected using the rear command dial.



## MF ASSIST

Choose how focus is displayed in manual focus mode.

Option	Description
<b>STANDARD</b>	Focus is displayed normally (focus peaking, digital split image, and digital microprism are not available).
<b>DIGITAL SPLIT IMAGE</b>	Displays a black-and-white ( <b>MONOCHROME</b> ) or color ( <b>COLOR</b> ) split image in the center of the frame. Frame the subject in the split-image area and rotate the focus ring until the four parts of the split image are correctly aligned.
<b>DIGITAL MICROPRISM</b>	A grid pattern that emphasizes blur is displayed when the subject is out of focus, disappearing to be replaced by a sharp image when the subject is in focus.
<b>FOCUS PEAK HIGHLIGHT</b>	The camera heightens high-contrast outlines. Choose a color and peaking level.

 You can also choose MF assist options by holding the center of the rear command dial.

## FOCUS CHECK

If **ON** is selected, the display will automatically zoom in on the selected focus area when the focus ring is rotated in manual focus mode.

Options	
ON	OFF

 • Pressing the center of the rear command dial cancels focus zoom.  
• The zoom position is centered on the current focus area and changes when the focus area is changed.

## INTERLOCK SPOT AE & FOCUS AREA

Select **ON** to meter the current focus frame in focus mode **S** or **C**.

Options	
<b>ON</b>	<b>OFF</b>

## INSTANT AF SETTING

Choose whether the camera focuses using single AF (**AF-S**) or continuous AF (**AF-C**) when a button to which focus lock or **AF-ON** is assigned is pressed in manual focus mode.

Options	
<b>AF-S</b>	<b>AF-C</b>

## DEPTH-OF-FIELD SCALE

Choose **FILM FORMAT BASIS** to help you make practical assessments of depth of field for pictures that will be viewed as prints and the like, **PIXEL BASIS** to help you assess depth of field for pictures that will be viewed at high resolutions on computers or other electronic displays.

Options	
<b>PIXEL BASIS</b>	<b>FILM FORMAT BASIS</b>

## RELEASE/FOCUS PRIORITY

Choose how the camera focuses in focus mode **AF-S** or **AF-C**.

Option	Description
<b>RELEASE</b>	Shutter response is prioritized over focus. Pictures can be taken when the camera is not in focus.
<b>FOCUS</b>	Focus is prioritized over shutter response. Pictures can be only taken when the camera is in focus.

## AF RANGE LIMITER

Limit the range of available focus distances for increased focus speed.

Option	Description
<b>OFF</b>	Focus limiter disabled.
<b>CUSTOM</b>	Limit focus to a range of distances defined by a minimum and maximum. <ul style="list-style-type: none"> <li>• <b>OK</b>: Limit focus to the selected range.</li> <li>• <b>SET</b>: Choose two objects and limit focus to the distance between them.</li> </ul>
<b>PRESET1</b> <b>PRESET2</b>	Limit focus to a preset range.







-  Choosing a focus range that includes distances shorter than the minimum focus distance of the lens disables the focus limiter.
- The values listed and displayed for the focus limiter may differ from the actual focus distance.

-  The following additional operations can be performed when **CUSTOM** is selected:
  - You can tap objects in the touch screen display to choose the focus range.
  - Instead of tapping an object in the display, you set the maximum focus distance to infinity by rotating the focus ring.





## TOUCH SCREEN MODE

Choose the shooting operations performed using touch controls.

### Still Photography

Mode	Description
 <b>TOUCH SHOOTING</b>	Tap your subject in the display to focus and release the shutter. In burst mode, pictures will be taken while you keep your finger on the display.
 <b>AF</b>   <b>AF OFF</b>	<ul style="list-style-type: none"><li>• In focus mode <b>S</b> (AF-S), the camera focuses when you tap your subject in the display. Focus locks at the current distance until you tap the <b>AF OFF</b> icon.</li><li>• In focus mode <b>C</b> (AF-C), the camera initiates focus when you tap your subject display. The camera will continue to adjust focus for changes in the distance to the subject until you tap the <b>AF OFF</b> icon.</li><li>• In manual focus mode (MF), you can tap the display to focus on the selected subject using autofocus.</li></ul>
 <b>AREA</b>	Tap to select a point for focus or zoom. The focus frame will move to the selected point.
 <b>OFF</b>	Touch controls disabled.

## Movie Recording

Mode	Description
 <b>TOUCH SHOOTING</b>	<p>Instead of pressing the shutter button, you can tap your subject in the display to focus and start recording. During recording, you can tap the display to focus as described below. <i>To end recording, press the shutter button.</i></p>
 <b>AF</b>	<p>Tapping the display focuses the camera on the selected point. <i>Use the shutter button to start and stop recording.</i></p> <ul style="list-style-type: none"> <li>• In focus mode <b>S</b> (AF-S), you can refocus at any time by tapping your subject in the display.</li> <li>• In focus mode <b>C</b> (AF-C), the camera will continuously adjust focus for changes in the distance to the subject at point selected by tapping the display.</li> <li>• In manual focus mode (MF), the camera will focus using auto-focus when you tap the display; during recording, you can tap the display again to move the focus area to a new location.</li> </ul>
 <b>AREA</b>	<p>Tap to position the focus area. <i>Use the shutter button to start and stop recording.</i></p> <ul style="list-style-type: none"> <li>• In focus mode <b>S</b> (AF-S), you can reposition the focus area at any time by tapping your subject in the display. To focus, use the button to which <b>AF-ON</b> is assigned.</li> <li>• In focus mode <b>C</b> (AF-C), the camera will continuously adjust focus for changes in the distance to the subject at point selected by tapping the display.</li> <li>• In manual focus mode (MF), you can tap the display to position the focus area over your subject.</li> </ul>
 <b>OFF</b>	<p>Touch controls disabled.</p>



To disable touch controls and hide the touch screen mode indicator, select **OFF** for **☑️ BUTTON/DIAL SETTING > TOUCH SCREEN SETTING > 📷 TOUCH SCREEN SETTING**.

## Touch Controls for Focus Zoom

Different touch controls are used during focus zoom (focus check enabled).

### Central Area

Tapping the center of the display performs the operations below.

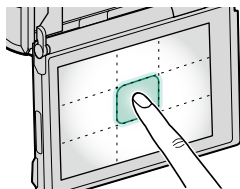

Mode	Still Photography	Movie Recording
<b>TOUCH SHOOTING</b>	<b>AF-S/MF:</b> Take a picture	<b>AF-S:</b> AF
		<b>MF:</b> Instant AF
<b>AF</b>	<b>AF-S:</b> AF	<b>AF-S:</b> AF
	<b>MF:</b> Instant AF	<b>MF:</b> Instant AF
<b>AREA</b>	<b>AF-S:</b> AF	<b>AF-S:</b> AF
	<b>MF:</b> Instant AF	<b>MF:</b> Instant AF
<b>OFF</b>	<b>AF-S/MF:</b> OFF	<b>AF-S/MF:</b> OFF

### Other Areas

Tapping other areas simply scrolls the display, whether during still photography or movie recording and regardless of the option selected for touch screen mode.

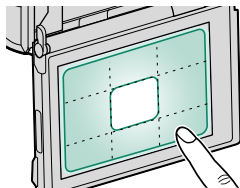

## CORRECTED AF FRAME

View a guide to the actual focus position when framing shots in the OVF with the subject close to the camera. When **ON** is selected, the camera will display the focus position for objects approximately 50 cm from the camera (②) in addition to the standard AF frame (①). Pressing the shutter button halfway displays a green AF frame (③) at the actual focus position.

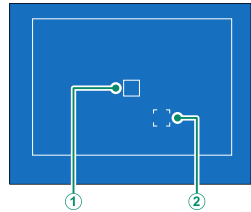

*Normal display*

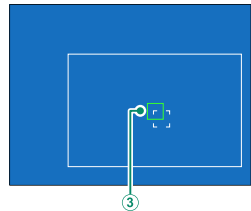

*Display when shutter button is pressed halfway*

Options	
ON	OFF
<ul style="list-style-type: none"> <li>The guide will not be displayed when the camera focuses at distances of less than 50 cm.</li> <li>You can temporarily select <b>OFF</b> for the guide display by pressing the center of the focus stick (focus lever).</li> </ul>	

## SHOOTING SETTING

Adjust shooting options.

To display shooting options, press **MENU/OK** in the shooting display and select the **SHOOTING SETTING** tab.

 The options available vary with the shooting mode selected.

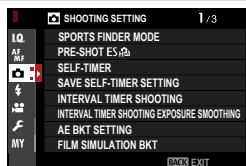

## SPORTS FINDER MODE

Take pictures using the crop in the center of the display. Choose this option for pictures of athletes, birds, and other moving subjects.

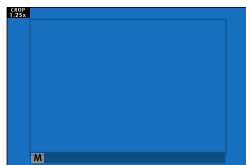

Option	Description
<b>ON</b>	Pictures are taken using a 1.25× crop, reducing the picture angle by an amount equivalent to increasing lens focal length by 1.25×; the crop is shown by a frame in the display.
<b>OFF</b>	The 1.25× crop is disabled.

-  • The **IMAGE QUALITY SETTING > IMAGE SIZE** item in the shooting menu is fixed at **M**.
- The sports finder is not available in modes that offer an electronic shutter.



**PRE-SHOT ES** 



To reduce the lag between your pressing the shutter button all the way down and the resulting picture being recorded to the memory card, the camera starts shooting with the electronic shutter when the shutter button is pressed halfway and saves a series shots starting just before the shutter button is pressed the rest of the way down.

Options	
ON	OFF

 Pre-shot photography is available only when **ES ELECTRONIC SHUTTER** is selected in **CONTINUOUS ES** drive mode.

## SELF-TIMER

Choose a shutter release delay.

Option	Description
 <b>2 SEC</b>	The shutter is released two seconds after the shutter button is pressed. Use to reduce blur caused by the camera moving when the shutter button is pressed. The self-timer lamp blinks as the timer counts down.
 <b>10 SEC</b>	The shutter is released ten seconds after the shutter button is pressed. Use for photographs in which you wish to appear yourself. The self-timer lamp blinks immediately before the picture is taken.
<b>OFF</b>	Self-timer off.

If an option other than **OFF** is selected, the timer will start when the shutter button is pressed all the way down. The display shows the number of seconds remaining until the shutter is released. To stop the timer before the picture is taken, press **DISP/BACK**.



-  Stand behind the camera when using the shutter button. Standing in front of the lens can interfere with focus and exposure.
- The self-timer turns off automatically when the camera is turned off.

## SAVE SELF-TIMER SETTING

If **ON** is selected, the chosen self-timer setting will remain in effect after a picture is taken or the camera is turned off.

Options	
<b>ON</b>	<b>OFF</b>

## INTERVAL TIMER SHOOTING

Configure the camera to take photos automatically at a preset interval.

- 1 Highlight **INTERVAL TIMER SHOOTING** in the  (**SHOOTING SETTING**) tab and press **MENU/OK**.

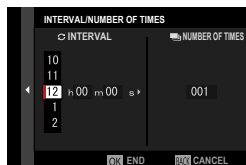

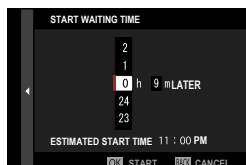

- 2 Use the focus stick (focus lever) to choose the interval and number of shots. Press **MENU/OK** to proceed.

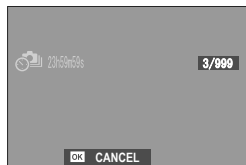

- 3 Use the focus stick to choose the starting time and then press **MENU/OK**. Shooting will start automatically.



 Interval timer photography cannot be used at a shutter speed of **B** (bulb) or with multiple exposure photography. In burst mode, only one picture will be taken each time the shutter is released.

-  • Use of a tripod is recommended.
- We recommend using an AC-9V AC power adapter.
- The display turns off between shots and lights a few seconds before the next shot is taken.
- The display can be activated at any time by pressing the shutter button.
- To continue shooting until the number of shots taken equals the number of exposures remaining at the time interval-timer photography started, set the number of shots to ∞.

## INTERVAL TIMER SHOOTING EXPOSURE SMOOTHING

Select **ON** to automatically adjust exposure during interval-timer photography to prevent it changing dramatically between shots.

Options	
ON	OFF



- Large changes in subject brightness may make exposure appear erratic. We recommend that you choose shorter values for **INTERVAL TIMER SHOOTING > INTERVAL** with subjects that brighten or dim dramatically during shooting.
- In manual mode (mode **M**), exposure smoothing is only available if an **A** (auto) option is selected for sensitivity.











## AE BKT SETTING

Adjust exposure bracketing settings.

Option	Description
<b>FRAMES/STEP SETTING</b>	Choose the number of shots in the bracketing sequence and the amount exposure is varied with each shot. <ul style="list-style-type: none"> <li>• <b>FRAMES</b>: Choose the number of shots in the bracketing sequence.</li> <li>• <b>STEP</b>: Choose the amount exposure is varied with each shot.</li> </ul>
<b>1 FRAME/CONTINUOUS</b>	<ul style="list-style-type: none"> <li>• <b>1 FRAME</b>: The shots in the bracketing sequence are taken one at a time.</li> <li>• <b>CONTINUOUS</b>: The shots in the bracketing sequence are taken in a single burst.</li> </ul>
<b>SEQUENCE SETTING</b>	Choose the order in which the shots are taken.

## FILM SIMULATION BKT

Choose the three film simulation types used for film simulation bracketing (📖 100).

Options		
 <b>PROVIA/STANDARD</b>	 <b>Velvia/VIVID</b>	 <b>ASTIA/SOFT</b>
 <b>CLASSIC CHROME</b>	 <b>PRO Neg. Hi</b>	 <b>PRO Neg. Std</b>
 <b>CLASSIC Neg.</b>	 <b>ETERNA/CINEMA</b>	 <b>ACROS*</b>
 <b>MONOCHROME*</b>	 <b>SEPIA</b>	

\* Available with yellow (**Ye**), red (**R**), and green (**G**) filters.

## FOCUS BKT SETTING

Choose from **AUTO** and **MANUAL** focus bracketing modes.

### MANUAL

In **MANUAL** mode, you choose the following.

Option	Description
<b>FRAMES</b>	Choose the number of shots.
<b>STEP</b>	Choose the amount focus changes with each shot.
<b>INTERVAL</b>	Choose the interval between shots.

### Focus and FRAMES/STEP

The relation between focus and the options chosen for **FRAMES** and **STEP** is shown in the illustration.

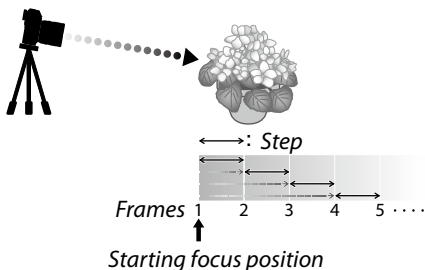



- Focus proceeds from the starting position toward infinity.
- Small **STEP** values translate to small changes in focus, larger values to larger changes.
- Regardless of the option chosen for **FRAMES**, shooting ends when focus reaches infinity.

**AUTO**

In **AUTO** mode, the camera calculates **FRAMES** and **STEP** automatically.

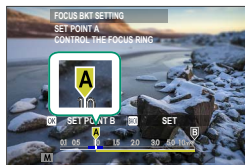
- 1 Select **SHOOTING SETTING** in the shooting menu, highlight **FOCUS BKT SETTING**, and press **MENU/OK**.
- 2 Select **AUTO** and choose an **INTERVAL**.  
The view through the lens will be displayed.
- 3 Focus on the nearest end of the subject and press **MENU/OK**.  
The selected focus distance appears as **A** on the focus distance indicator.



 The same focus range can be chosen by focusing on the farthest end of the subject first.

- 4 Focus on the farthest end of the subject and press **DISP/BACK**.  
The selected focus distance (**B**) and focus range (**A to B**) appear on the focus distance indicator.

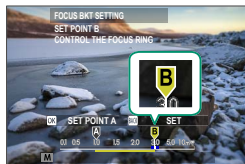

 Instead of pressing the **DISP/BACK** button, you can press **MENU/OK** and select **A** again.

- 5 Take photographs.  
The camera will calculate values for **FRAMES** and **STEP** automatically. The number of frames will appear in the display.



## MULTIPLE EXPOSURE CTRL

Choose how the camera combines shots to create a multiple exposure.

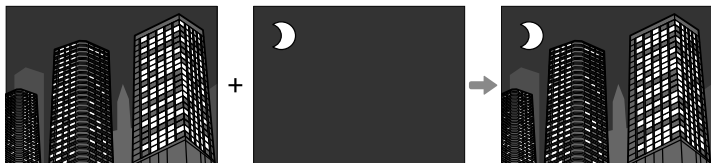

Option	Description
<b>ADDITIVE</b>	The camera adds the exposures together. You may need to lower exposure compensation depending on the number of shots.
<b>AVERAGE</b>	The camera automatically optimizes exposure for the final picture. The background in series shot without changing the composition will be optimally exposed.
<b>BRIGHT</b>	The camera compares the exposures and chooses only the brightest pixel at each location. Colors may be mixed depending on their brightness and hue.
<b>DARK</b>	The camera compares the exposures and chooses only the darkest pixel at each location. Colors may be mixed depending on their brightness and hue.





 The camera can combine up to nine exposures.



## PHOTOMETRY

Choose how the camera meters exposure.

 The selected option will only take effect when **AF/MF SETTING** > **FACE/EYE DETECTION SETTING** is **OFF**.

Mode	Description
 (multi)	The camera instantly determines exposure based on an analysis of composition, color, and brightness distribution. Recommended in most situations.
 (center-weighted)	The camera meters the entire frame but assigns the greatest weight to the area at the center.
 (spot)	The camera meters lighting conditions in an area at the center of the frame equivalent to 2% of the total. Recommended with backlit subjects and in other cases in which the background is much brighter or darker than the main subject.
 (average)	Exposure is set to the average for the entire frame. Provides consistent exposure across multiple shots with the same lighting, and is particularly effective for landscapes and portraits of subjects dressed in black or white.

## SHUTTER TYPE

Choose the shutter type. Choose the electronic shutter to mute the shutter sound.

Option	Description
<b>MS MECHANICAL SHUTTER</b>	Take pictures with the mechanical shutter.
<b>ES ELECTRONIC SHUTTER</b>	Take pictures with the electronic shutter.
<b>EF E-FRONT CURTAIN SHUTTER</b>	The camera chooses the mechanical or electronic front curtain shutter according to shooting conditions.
<b>M<sub>E</sub> MECHANICAL + ELECTRONIC</b>	The camera chooses the mechanical or electronic shutter according to shooting conditions.
<b>EF<sub>M</sub> E-FRONT + MECHANICAL</b>	The camera chooses the mechanical or electronic front curtain shutter according to shooting conditions.
<b>EF<sub>M+E</sub> E-FRONT + MECHANICAL + ELECTRONIC</b>	The camera chooses the mechanical, electronic, or electronic front curtain shutter according to shooting conditions.

If **ES ELECTRONIC SHUTTER**, **M<sub>E</sub> MECHANICAL + ELECTRONIC**, or **EF<sub>M+E</sub> E-FRONT + MECHANICAL + ELECTRONIC** is selected, shutter speeds faster than  $\frac{1}{8000}$  s can be chosen by rotating the shutter speed dial to **8000** and then rotating the rear command dial.

- ⓘ • When using the electronic shutter, note the following:
  - Distortion may be visible in shots of moving subjects.
  - Distortion may also be visible in hand-held shots taken at high shutter speeds; use of a tripod is recommended.
  - Banding and fog may occur in shots taken under fluorescent lights or other flickering or erratic illumination.
  - When taking pictures with the shutter muted (🔇 200), respect your subjects' image rights and right to privacy.
- When using the electronic front-curtain shutter, note the following:
  - Faster shutter speeds are more likely to result in uneven exposure and loss of resolution in out-of-focus areas of the frame.
- 📄 The following restrictions apply when the electronic shutter is used:
  - "Extended" sensitivity values are not supported
  - Long exposure noise reduction has no effect
  - The flash cannot be used

## FLICKER REDUCTION



Reduce flicker in pictures and the display when shooting under fluorescent lighting and other similar light sources.

Option	Description
<b>ALL FRAMES</b>	Flicker reduction is applied to all frames continuous shooting frame rate reduces.
<b>FIRST FRAME</b>	Flicker measurement is taken prior to the first frame only and the same reduction amount is applied to all subsequent frames that flicker may occur.
<b>OFF</b>	Flicker reduction disabled.

-  • Flicker reduction increases the time needed to record pictures.
- **OFF** is selected for **FLICKER REDUCTION** when the electronic shutter is used.
- Flicker reduction is not available during movie recording.

## IS MODE

Choose from the following image stabilization options:

Option	Description
 <b>CONTINUOUS</b>	Image stabilization on.
 <b>SHOOTING ONLY</b>	As above, except that image stabilization is performed only when the shutter button is pressed halfway (focus mode <b>C</b> only) or the shutter is released.
<b>OFF</b>	Image stabilization off. Choose this option when using a tripod.

 This option is available only with lenses that support image stabilization.

## ISO AUTO SETTING

Choose the base sensitivity, maximum sensitivity, and minimum shutter speed for the **A** position on the sensitivity dial. Settings for **AUTO1**, **AUTO2**, and **AUTO3** can be stored separately; the defaults are shown below.

Item	Options	Default		
		AUTO1	AUTO2	AUTO3
<b>DEFAULT SENSITIVITY</b>	160–12800	160		
<b>MAX. SENSITIVITY</b>	400–12800	800	1600	3200
<b>MIN. SHUTTER SPEED</b>	$\frac{1}{500}$ – $\frac{1}{4}$ SEC, AUTO	$\frac{1}{60}$ SEC		

The camera automatically chooses a sensitivity between the default and maximum values; sensitivity is only raised above the default value if the shutter speed required for optimal exposure would be slower than the value selected for **MIN. SHUTTER SPEED**.

-  • If the value selected for **DEFAULT SENSITIVITY** is higher than that selected for **MAX. SENSITIVITY**, **DEFAULT SENSITIVITY** will be set to the value selected for **MAX. SENSITIVITY**.
- The camera may select shutter speeds slower than **MIN. SHUTTER SPEED** if pictures would still be underexposed at the value selected for **MAX. SENSITIVITY**.
- If **AUTO** is selected for **MIN. SHUTTER SPEED**, the camera will automatically choose a minimum shutter speed approximately equal to the inverse of the lens' focal length, in seconds (for example, if the lens has a focal length of 50 mm, the camera will choose a minimum shutter speed in the neighborhood of  $\frac{1}{50}$  s). The minimum shutter speed is not affected by the option selected for image stabilization.

## MOUNT ADAPTER SETTING

Adjust settings for lenses attached via a mount adapter.

### Bright Frame Brightness

Adjust the brightness of the bright frame in the OVF display.

### Saved Settings

Store settings for up to 6 lenses.

### Choosing a Focal Length

Use the focus stick (focus lever) to enter the focal length.

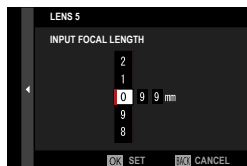

### Distortion Correction

Choose from **STRONG**, **MEDIUM**, or **WEAK** options to correct **BARREL** or **PINCUSHION** distortion.

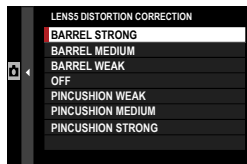

### **Color Shading Correction**

Color (shading) variations between the center and edges of the frame can be adjusted separately for each corner.

To use color shading correction, follow the steps below.

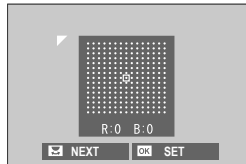



- 1 Rotate the rear command dial to choose a corner. The selected corner is indicated by a triangle.
- 2 Use the focus stick (focus lever) to adjust shading until there is no visible difference in color between the selected corner and the center of the image.
  - Press the focus stick left or right to adjust colors on the cyan–red axis.
  - Press the focus stick up or down to adjust colors on the blue–yellow axis.

 To determine the amount required, adjust color shading correction while taking photos of blue sky or a sheet of gray paper.

### **Peripheral Illumination Correction**

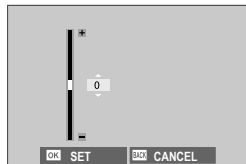
Choose from values between  $-5$  and  $+5$ . Choosing positive values increases peripheral illumination, while choosing negative values reduces peripheral illumination. Positive values are recommended for vintage lenses, negative values to create the effect of images taken with an antique lens or a pinhole camera.



 To determine the amount required, adjust peripheral illumination correction while taking photos of blue sky or a sheet of gray paper.

### **EDIT LENS NAME**

Change the lens name.

## WIRELESS COMMUNICATION

Connect to smartphones running the latest version of the FUJIFILM Camera Remote app. The smartphone can then be used to:

- Control the camera and take pictures remotely
- Receive pictures uploaded from the camera
- Browse the pictures on the camera and download selected pictures
- Upload location data to the camera



For downloads and other information, visit:

[http://app.fujifilm-dsc.com/en/camera\\_remote/](http://app.fujifilm-dsc.com/en/camera_remote/)



## FLASH SETTING

Adjust flash-related settings.

To display flash-related settings, press **MENU/OK** in the shooting display and select the **⚡ (FLASH SETTING)** tab.

 The options available vary with the shooting mode selected.

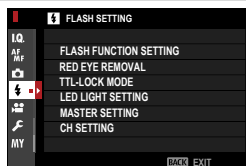

## FLASH FUNCTION SETTING

Choose a flash control mode, flash mode, or sync mode or adjust the flash level. The options available vary with the flash.

 For more information on flash settings, see “External Flash Units” (📖 258) in “Peripherals and Optional Accessories”.



## RED EYE REMOVAL

Remove red-eye effects caused by the flash.

Option	Description
<b>FLASH+REMOVAL</b>	A red-eye reduction pre-flash is combined with digital red-eye removal.
<b>FLASH</b>	Flash red-eye reduction only.
<b>REMOVAL</b>	Digital red-eye removal only.
<b>OFF</b>	Flash red-eye reduction and digital red-eye removal off.

-  Flash red-eye reduction can be used in TTL flash control mode.
- Digital red-eye removal is performed only when a face is detected.
- Digital red-eye removal is not available with RAW images.

## TTL-LOCK MODE

Instead of adjusting flash level with each shot, TTL flash control can be locked for consistent results across a series of photographs.

Option	Description
<b>LOCK WITH LAST FLASH</b>	Flash output is locked at the value metered for the most recent photo.
<b>LOCK WITH METERING FLASH</b>	The camera emits a series of pre-flashes and locks flash output at the metered value.

- To use TTL lock, assign **TTL-LOCK** to a camera control and then use the control to enable or disable TTL lock (📖 248).
- Flash compensation can be adjusted while TTL lock is in effect.
- Selecting **LOCK WITH LAST FLASH** displays an error message if no previously metered value exists.

## LED LIGHT SETTING

Choose whether to use the flash unit's LED video light (if available) as a catchlight or AF-assist illuminator when taking photos.

Option	Role of LED video light in still photography
<b>CATCHLIGHT</b>	Catchlight
<b>AF ASSIST</b>	AF-assist illuminator
<b>AF ASSIST+CATCHLIGHT</b>	AF-assist illuminator and catchlight
<b>OFF</b>	None

- In some cases, this option can also be accessed via the **FLASH FUNCTION SETTING** menu.

## MASTER SETTING

Choose a flash group (A, B, or C) for the flash mounted on the camera hot shoe when it functions as a master flash controlling remote flash units via Fujifilm wireless optical flash control, or choose **OFF** to limit master flash output to a level that does not affect the final picture.

Options			
Gr A	Gr B	Gr C	OFF

 In some cases, this option can also be accessed via the **FLASH FUNCTION SETTING** menu.

## CH SETTING

Choose the channel used for communication between the master flash and remote flash units when using Fujifilm optical wireless flash control. Separate channels can be used for different flash systems or to prevent interference when multiple systems are operating in close proximity.

Options			
CH1	CH2	CH3	CH4

## MOVIE SETTING

Adjust movie-recording options.

To display options for movie recording, press **MENU/OK** in the shooting display and select the **MOVIE SETTING** tab.

 The options available vary with the shoot-  
ing mode selected.

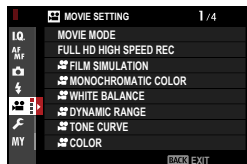

## MOVIE MODE

Before shooting movies, choose the frame rate, bit rate, and frame size and aspect ratio.

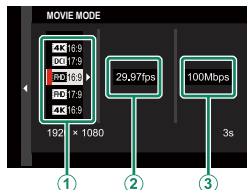

- 1 In the shooting menu, select **MOVIE SETTING**, then highlight **MOVIE MODE** and press **MENU/OK**.
- 2 Press the focus stick (focus lever) up or down to highlight the desired frame size and aspect ratio (1) and press the stick right.
  - Choose **4K 16:9** or **DCI 17:9** for 4K movies with aspect ratios of 16 or 17 to 9.
  - Choose **FHD 16:9** or **FHD 17:9** for Full HD movies with aspect ratios of 16 or 17 to 9.

- 3 Press the focus stick (focus lever) up or down to highlight a frame rate (2) and press the stick right.

Options					
23.98P	24P	25P	29.97P	50P	59.94P













- 4 Press the focus stick up or down to highlight a bit rate (3) and press MENU/OK.

Options		
50Mbps	100Mbps	200Mbps

 The choice of frame and bit rates varies with the movie mode.

## FULL HD HIGH SPEED REC

Record high-frame-rate Full HD movies. High-frame-rate movies can be played back in slow motion, giving you time to view fast-moving subjects or details too fleeting for the naked eye.

Option	Description
2x  59.94P  120P	Record Full HD footage at frame rates of 120 or 100 fps. The movies play back at 1/2, 1/4, or 1/5 speed. Maximum recording length is 6 minutes. The footage recorded to the memory card is compressed with the goal of keeping the amount of data recorded to 200 Mbps per second.
2x  50P  100P	
4x  29.97P  120P	
4x  25P  100P	
5x  24P  120P	
5x  23.98P  120P	
OFF	High-speed recording off.

 High-speed movies are recorded with no sound.

## FILM SIMULATION

Choose a film simulation effect for movie recording.

Option	Description
<b>STD</b> PROVIA/STANDARD	See "FILM SIMULATION" (📖 100).
<b>V</b> Velvia/VIVID	
<b>S</b> ASTIA/SOFT	
<b>C</b> CLASSIC CHROME	
<b>NH</b> PRO Neg. Hi	
<b>NS</b> PRO Neg. Std	
<b>NC</b> CLASSIC Neg.	
<b>E</b> ETERNA/CINEMA	
<b>A</b> ACROS	
<b>B</b> MONOCHROME	
<b>SEPIA</b> SEPIA	





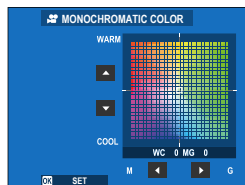





## MONOCHROMATIC COLOR

Add a reddish or bluish tinge (warm or cool color cast) to the **A** ACROS and **B** MONOCHROME monochrome film simulations. Color can be adjusted on the **WARM-COOL** and **G** (Green)-**M** (Magenta) axes.





## WHITE BALANCE







Adjust white balance for movie recording.

Option	Description
<b>AUTO</b>	See "WHITE BALANCE" (📖 104).
 1/  2/  3	
	
	
	
	
	
	
	

## DYNAMIC RANGE

Choose a dynamic range for movie recording.

Option	Description
 100 <b>100%</b>	See "DYNAMIC RANGE" (📖 107).
 200 <b>200%</b>	
 400 <b>400%</b>	

-  Auto dynamic range adjustment (**AUTO**) is not supported.
-  **200%** is available at sensitivities of from ISO 320 to ISO 12800,  **400%** at sensitivities of from ISO 640 to 12800.
- The  **MOVIE SETTING** >  **DYNAMIC RANGE** option is available when **OFF** is selected for  **MOVIE SETTING** > **F-Log RECORDING**.

## TONE CURVE

With reference to a tone curve, use the focus stick (focus lever) to adjust the appearance of highlights or shadows, making them harsher or softer. Choose higher values to make shadows and highlights harsher, lower values to make them softer.

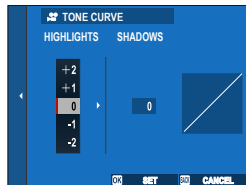

### Options

-2	-1	0	+1	+2	+3	+4
----	----	---	----	----	----	----

## COLOR

Adjust color density for movie recording. Choose higher values to increase saturation, lower values to reduce it.

### Options

-4	-3	-2	-1	0	+1	+2	+3	+4
----	----	----	----	---	----	----	----	----

## SHARPNESS

Sharpen or soften outlines in movies. Choose higher values for sharper outlines, lower values for softer outlines.

### Options

-4	-3	-2	-1	0	+1	+2	+3	+4
----	----	----	----	---	----	----	----	----



## NOISE REDUCTION

Reduce noise in movies shot at high sensitivities. Choose higher values to reduce noise and smooth outlines, lower values to leave outlines visible.

Options								
-4	-3	-2	-1	0	+1	+2	+3	+4

## INTERFRAME NR

Select **ON** to enable interframe noise reduction.

Options	
ON	OFF

-  Interframe noise reduction is available only when frame rates of **29.97P** or slower are selected at a frame size of **4K** or **DCI**.
- “Ghosting” may occur with moving subjects or if the camera is moved during shooting.

## F-Log RECORDING

Select **ON** to record movies using a soft gamma curve with a wide gamut suitable for further processing post-production. Sensitivity is restricted to values between ISO 640 and 12800.

Options	
<b>ON</b>	<b>OFF</b>

## PERIPHERAL LIGHT CORRECTION

Select **ON** to enable peripheral illumination correction during movie recording.

Options	
<b>ON</b>	<b>OFF</b>

- If **ON** is selected when a lens that does not transmit data to the camera is attached using a FUJIFILM M MOUNT ADAPTER (available separately), peripheral illumination will be adjusted according to the option selected for **SHOOTING SETTING > MOUNT ADAPTER SETTING > PERIPHERAL ILLUMINATION CORRECTION** in the shooting menu (📖 147).
- Select **OFF** if you notice banding in movies recorded using this option.

## FOCUS AREA

Choose the focus area for movies shot using autofocus. You can also choose the focus area (and consequently also the focus zoom position) for movies shot using manual focus.

## MOVIE AF MODE

Choose how the camera selects the focus point for movie recording.

Option	Description
<b>MULTI</b>	Automatic focus-point selection.
<b>AREA</b>	The camera focuses on the subject in the selected focus area.

## AF-C CUSTOM SETTING

Select focus-tracking options when recording movies in focus mode **C**.

### TRACKING SENSITIVITY

Choose how long the camera waits to switch focus when an object enters the focus area behind or in front of the current subject. See “TRACKING SENSITIVITY” (📖 117).

Options				
0	1	2	3	4

### AF SPEED

Adjust the autofocus response speed. Choose higher values for faster response times, lower values for slower response times.

Options										
-5	-4	-3	-2	-1	0	+1	+2	+3	+4	+5

## FACE/EYE DETECTION SETTING

Enable or disable Intelligent Face Detection when recording movies.

Option	Description
<b>FACE DETECTION ON</b>	See “FACE/EYE DETECTION SETTING” (📖 122).
<b>OFF</b>	Intelligent Face Detection and eye priority off.

 When Intelligent Face Detection is enabled, the camera will focus using continuous AF even when single AF (**S**) is chosen with the focus mode selector. Intelligent Face Detection is not available in manual focus mode.

## MF ASSIST

Choose how focus is displayed in manual focus mode.

Option	Description
<b>STANDARD</b>	Focus is displayed normally (focus peaking is not available).
<b>FOCUS PEAK HIGHLIGHT</b>	The camera heightens high-contrast outlines. Choose a color and peaking level.



## FOCUS CHECK

If **ON** is selected, the display will automatically zoom in on the selected focus area when the focus ring is rotated in manual focus mode.

Options	
<b>ON</b>	<b>OFF</b>

## ZEBRA SETTING

Highlights that may be overexposed are shown by zebra stripes in the movie mode display.

Option	Description
<b>ZEBRA RIGHT</b>	 Right-slanting stripes.
<b>ZEBRA LEFT</b>	 Left-slanting stripes.
<b>OFF</b>	Stripes off.

## ZEBRA LEVEL

Choose the brightness threshold for the zebra stripe display.

Options										
50	55	60	65	70	75	80	85	90	95	100

## AUDIO SETTING

Adjust audio-related settings for movie recording.

### INTERNAL MIC LEVEL ADJUSTMENT

Adjust the recording level for the built-in microphone.

Option	Description
<b>AUTO</b>	The camera adjusts the recording level automatically.
<b>MANUAL</b>	Adjust the recording level manually. Press the focus stick (focus lever) right to choose from 25 recording levels.
<b>OFF</b>	Turn the built-in microphone off.

## EXTERNAL MIC LEVEL ADJUSTMENT

Adjust the recording level for external microphones.

Option	Description
<b>AUTO</b>	The camera adjusts the recording level automatically.
<b>MANUAL</b>	Adjust the recording level manually. Press the focus stick (focus lever) right to choose from 25 recording levels.
<b>OFF</b>	Disable recording using external microphones.

## MIC LEVEL LIMITER

Reduces distortion caused by input that exceeds the limits of the microphone's audio circuits.

Options	
<b>ON</b>	<b>OFF</b>

## WIND FILTER

Choose whether to enable wind noise reduction during movie recording.

Options	
<b>ON</b>	<b>OFF</b>

## LOW CUT FILTER

Choose whether to enable the low-cut filter, reducing low-frequency noise during movie recording.

Options	
<b>ON</b>	<b>OFF</b>



## HEADPHONES VOLUME

Adjust the headphone volume.

Option	Description
<b>0</b>	Mute output to the headphones.
<b>1—10</b>	Choose a volume of from 1 to 10.

## MIC/REMOTE RELEASE

Specify whether the device connected to the microphone/remote release connector is a microphone or a remote release.

Options	
 MIC	 REMOTE

## TIME CODE SETTING

Adjust time code (hour, minute, second, and frame number) display settings for movie recording.

### TIME CODE DISPLAY

Select **ON** to display time codes during movie recording and playback.

Options	
<b>ON</b>	<b>OFF</b>

### START TIME SETTING

Choose the time code starting time.

Option	Description
<b>MANUAL INPUT</b>	Highlight this option and press the focus stick (focus lever) right to choose a start time manually.
<b>CURRENT TIME</b>	Set the start time to the current time.
<b>RESET</b>	Set the start time to 00:00:00.

### COUNT UP SETTING

Choose whether time is clocked continuously or only during movie recording.

Option	Description
<b>REC RUN</b>	Time is clocked only during movie recording.
<b>FREE RUN</b>	Time is clocked continuously.

## DROP FRAME

At frame rates of **59.94P**, and **29.97P**, a discrepancy will gradually develop between the time code (measured in seconds) and the actual recording time (measured in fractions of a second). Choose whether the camera drops frames as necessary to match the recording time to the time code.

Option	Description
<b>ON</b>	The camera drops frames as necessary to maintain a strict match between the time code and the actual recording time.
<b>OFF</b>	Frames are not dropped.



- The time code display varies with the option selected.

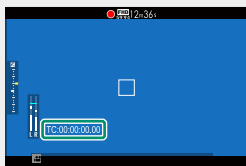

TC:00:00:00:00

**ON**

TC:00:00:00:00

**OFF**

- Selecting a frame rate of **23.98P** disables frame drop.



## TALLY LIGHT



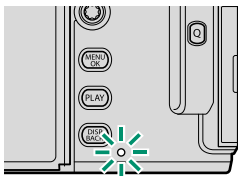



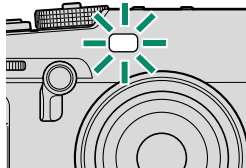

Choose the lamp (indicator or AF-assist) that lights during movie recording and whether the lamp blinks or remains steady.



*Indicator lamp*



*AF-assist illuminator*

Option	Description
<b>FRONT OFF</b> <b>REAR</b> 	The indicator lamp lights during movie recording.
<b>FRONT OFF</b> <b>REAR</b> 	The indicator lamp blinks during movie recording.
<b>FRONT</b>  <b>REAR</b> 	The indicator and AF-assist lamps light during movie recording.
<b>FRONT</b>  <b>REAR OFF</b>	The AF-assist lamp lights during movie recording.
<b>FRONT</b>  <b>REAR</b> 	The indicator and AF-assist lamps blink during movie recording.
<b>FRONT</b>  <b>REAR OFF</b>	The AF-assist lamp blinks during movie recording.
<b>FRONT OFF</b> <b>REAR OFF</b>	The indicator and AF-assist lamps remain off during movie recording.

## MOVIE SILENT CONTROL

Select **ON** to disable camera dials and adjust movie settings using touch-screen controls, preventing the sounds made by camera controls being recorded with the movie (📖 24).

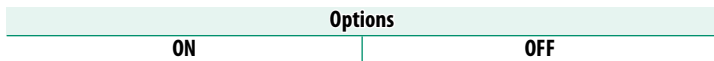

# Playback and the Playback Menu

# 7

## The Playback Display

This section lists the indicators that may be displayed during playback.

For illustrative purposes, displays are shown with all indicators lit.

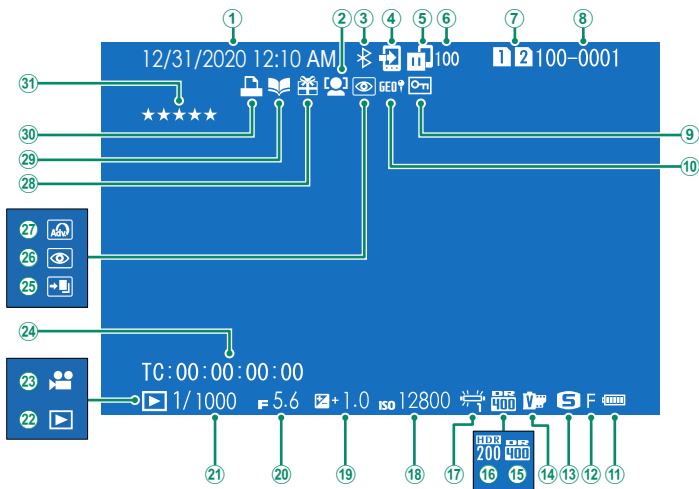

① Date and time.....	40, 42, 195	①⑦ White balance .....	104
② Face detection indicator .....	122	①⑧ Sensitivity .....	79
③ Bluetooth ON/OFF.....	231	①⑨ Exposure compensation.....	82
④ Image transfer order.....	186	②⑩ Aperture.....	59, 64, 65
⑤ Image transfer status .....	231, 270	②① Shutter speed .....	59, 60, 65
⑥ Number of frames selected for upload... 186		②② Playback mode indicator .....	47
⑦ Card slot.....	173	②③ Movie icon .....	54
⑧ Frame number.....	227	②④ Time code.....	163
⑨ Protected image.....	180	②⑤ HDR image .....	91
⑩ Location data.....	237, 271	②⑥ Red-eye removal indicator.....	149, 182
⑪ Battery level.....	39	②⑦ Advanced filter.....	95
⑫ Image quality.....	99	②⑧ Gift image.....	47
⑬ Image size.....	98	②⑨ Photobook assist indicator .....	188
⑭ Film simulation .....	100	③⑩ DPOF print indicator.....	190
⑮ Dynamic range .....	107	③① Rating.....	184
⑯ HDR.....	91		

## The DISP/BACK Button

The **DISP/BACK** button controls the display of indicators during playback.

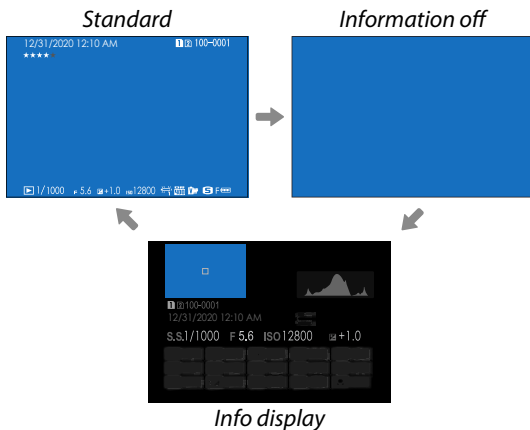

## Viewing Photo Information

The photo information display changes each time the focus stick (focus lever) is pressed up.

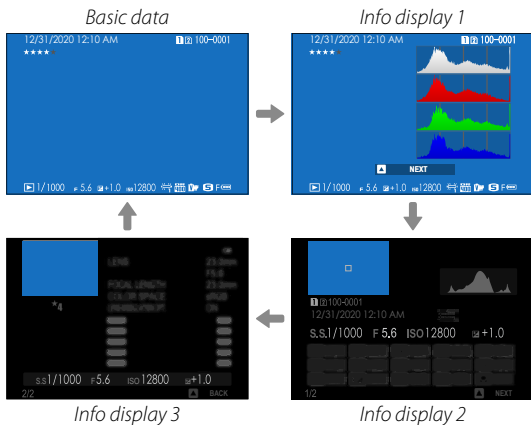
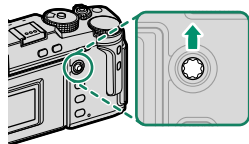

## Zooming in on the Focus Point

Press the center of the rear command dial to zoom in on the focus point. Press again to return to full-frame playback.

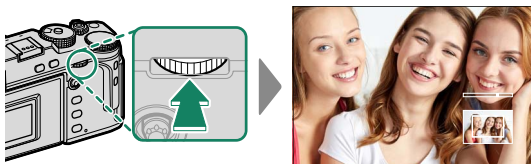

## Viewing Pictures

Read this section for information on playback zoom and multi-frame playback.

Use the rear command dial to go from full-frame playback to playback zoom or multi-frame playback.

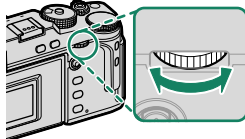

Full-frame playback



Multi-frame playback



Nine-frame view



Hundred-frame view

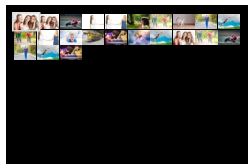

Playback zoom



Medium zoom



Maximum zoom



## Playback Zoom

Rotate the rear command dial right to zoom in on the current picture, left to zoom out. To exit zoom, press **DISP/BACK**, **MENU/OK**, or the center of the rear command dial.

- The maximum zoom ratio varies with the option selected for **IMAGE QUALITY SETTING > IMAGE SIZE**.
  - Playback zoom is not available with cropped or resized copies saved at a size of **640**.

### Scroll

When the picture is zoomed in, the focus stick (focus lever) can be used to view areas of the image not currently visible in the display.



*Navigation window*

## Multi-Frame Playback

To change the number of images displayed, rotate the rear command dial left when a picture is displayed full frame.

- Use the focus stick (focus lever) to highlight images and press **MENU/OK** to view the highlighted image full frame.
  - In the nine- and hundred-frame displays, press the focus stick up or down to view more pictures.



## The Playback Menu

Adjust playback settings.

The playback menu is displayed when you press **MENU/OK** in playback mode.

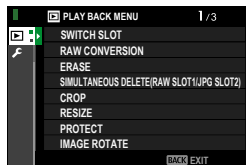

### SWITCH SLOT

Choose the card from which images will be played back.



If two memory cards are inserted, you can press and hold the **PLAY** button to choose a card for playback.

## RAW CONVERSION

Even if you don't have a computer, you can use the camera to modify RAW pictures and save them in other formats.

### Saving RAW Pictures in Another Format

- 1 Display a RAW picture.
- 2 Highlight **RAW CONVERSION** in the playback menu.
- 3 Press **MENU/OK**.  
A list of settings will be displayed.

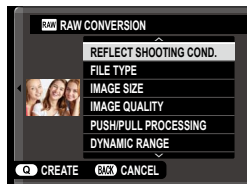

- 4 Press the focus stick (focus lever) up or down to highlight a setting.
- 5 Press the focus stick right to display options.

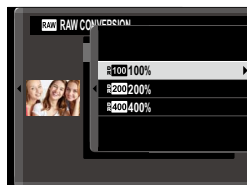

- 6 Press the focus stick up or down to highlight the desired option.
- 7 Press **MENU/OK** to select the highlighted option. The settings list shown in Step 3 will be displayed. Repeat Steps 4 to 7 to adjust additional settings.
- 8 Press the **Q** button.  
A preview of the copy will be displayed.
- 9 Press **MENU/OK**.  
The copy will be saved.

 RAW conversion options can also be displayed by pressing the **Q** button when a RAW picture is displayed during playback.

The settings that can be adjusted when converting pictures from RAW to another format are:

Setting	Description
<b>REFLECT SHOOTING COND.</b>	Create a copy using the settings in effect at the time the photo was taken.
<b>FILE TYPE</b>	Choose a file format.
<b>IMAGE SIZE</b>	Choose an image size.
<b>IMAGE QUALITY</b>	Adjust image quality.
<b>PUSH/PULL PROCESSING</b>	Adjust exposure.
<b>DYNAMIC RANGE</b>	Enhance details in highlights for natural contrast.
<b>D RANGE PRIORITY</b>	Reduce loss of detail in highlights and shadows for natural-looking results when photographing high-contrast scenes.
<b>FILM SIMULATION</b>	Simulate the effects of different types of film.
<b>MONOCHROMATIC COLOR</b>	Add a warm or cool cast to monochrome pictures.
<b>GRAIN EFFECT</b>	Add a film grain effect.
<b>COLOR CHROME EFFECT</b>	Increase the range of tones available for rendering colors that tend to be highly saturated, such as reds, yellows, and greens.
<b>COLOR CHROME FX BLUE</b>	Increase the range of tones available for rendering blues.
<b>WHITE BALANCE</b>	Adjust white balance.
<b>WB SHIFT</b>	Fine-tune white balance.
<b>TONE CURVE</b>	Adjust highlights and shadows.
<b>COLOR</b>	Adjust color density.
<b>SHARPNESS</b>	Sharpen or soften outlines.
<b>NOISE REDUCTION</b>	Process the copy to reduce mottling.
<b>CLARITY</b>	Increase definition.
<b>LENS MODULATION OPTIMIZER</b>	Improve definition by adjusting for diffraction and the slight loss of focus at the periphery of the lens.
<b>COLOR SPACE</b>	Choose the color space used for color reproduction.
<b>HDR</b>	Reduce loss of detail in highlights and shadows.

## ERASE

Delete individual pictures, multiple selected pictures, or all pictures.

 Deleted pictures cannot be recovered. Protect important pictures or copy them to a computer or other storage device before proceeding.

Option	Description
<b>FRAME</b>	Delete pictures one at a time.
<b>SELECTED FRAMES</b>	Delete multiple selected pictures.
<b>ALL FRAMES</b>	Delete all unprotected pictures.

## FRAME

- 1 Select **FRAME** for **ERASE** in the playback menu.
- 2 Press the focus stick (focus lever) left or right to scroll through pictures and press **MENU/OK** to delete.

 • A confirmation dialog is not displayed before pictures are deleted; be sure the correct picture is selected before pressing **MENU/OK**.

- Additional pictures can be deleted by pressing **MENU/OK**. Press the focus stick left or right to scroll through pictures and press **MENU/OK** to delete.

## SELECTED FRAMES

---

- 1 Select **SELECTED FRAMES** for **ERASE** in the playback menu.
- 2 Highlight pictures and press **MENU/OK** to select.
  - Selected pictures are indicated by check marks (☑).
  - To deselect a highlighted picture, press **MENU/OK** again.
- 3 When the operation is complete, press **DISP/BACK** to display a confirmation dialog.
- 4 Highlight **OK** and press **MENU/OK** to delete the selected pictures.



Pictures in photobooks or printer orders are shown by .

## ALL FRAMES

---

- 1 Select **ALL FRAMES** for **ERASE** in the playback menu.
- 2 A confirmation dialog will be displayed; highlight **OK** and press **MENU/OK** to delete all unprotected pictures.



- Pressing **DISP/BACK** cancels deletion; note that any pictures deleted before the button was pressed cannot be recovered.
- If a message appears stating that the selected images are part of a DPOF print order, press **MENU/OK** to delete the pictures.

## SIMULTANEOUS DELETE(RAW SLOT1/JPG SLOT2)

Taking photos with **RAW/JPEG** selected for **SAVE DATA SET-UP > CARD SLOT SETTING (STILL IMAGE)** creates two copies. Choose whether deleting the RAW image will also delete the JPEG copy.

Option	Description
<b>ON</b>	Deleting the RAW image from the card in Slot 1 also deletes the JPEG copy from the card in Slot 2.
<b>OFF</b>	Deleting the RAW image from the card in Slot 1 does not delete the JPEG copy from the card in Slot 2.

## CROP

Create a cropped copy of the current picture.

- 1 Display the desired picture.
- 2 Select **CROP** in the playback menu.
- 3 Use the rear command dial to zoom in and out and press the focus stick (focus lever) up, down, left, or right to scroll the picture until the desired portion is displayed.
- 4 Press **MENU/OK** to display a confirmation dialog.
- 5 Press **MENU/OK** again to save the cropped copy to a separate file.

-  • The higher the zoom ratio, the smaller the number of pixels in the cropped copy.
- If the size of the final copy will be **640**, **YES** will be displayed in yellow.
- All copies have an aspect ratio of 3:2.

## RESIZE

Create a small copy of the current picture.

---

- 1 Display the desired picture.
- 2 Select **RESIZE** in the playback menu.
- 3 Highlight a size and press **MENU/OK** to display a confirmation dialog.
- 4 Press **MENU/OK** again to save the resized copy to a separate file.





The sizes available vary with the size of the original image.

## PROTECT

Protect pictures from accidental deletion. Highlight one of the following options and press **MENU/OK**.

Option	Description
<b>FRAME</b>	Protect selected pictures. Press the focus stick (focus lever) left or right to view pictures and press <b>MENU/OK</b> to select or deselect. Press <b>DISP/BACK</b> when the operation is complete.
<b>SET ALL</b>	Protect all pictures.
<b>RESET ALL</b>	Remove protection from all pictures.

-  Protected pictures will be deleted when the memory card is formatted.
-  Protecting images currently selected for upload to paired smartphones or tablets removes upload marking.



## IMAGE ROTATE

Rotate pictures.

- 1 Display the desired picture.
- 2 Select **IMAGE ROTATE** in the playback menu.
- 3 Press the focus stick (focus lever) down to rotate the picture 90° clockwise, up to rotate it 90° counterclockwise.
- 4 Press **MENU/OK**. The picture will automatically be displayed in the selected orientation whenever it is played back on the camera.



- Protected pictures cannot be rotated. Remove protection before rotating pictures.
- The camera may not be able to rotate pictures created with other devices. Pictures rotated on the camera will not be rotated when viewed on a computer or on other cameras.
- Pictures taken with **SCREEN SET-UP > AUTOROTATE PB** are automatically displayed in the correct orientation during playback.

## RED EYE REMOVAL

Remove red-eye from portraits. The camera will analyze the image; if red-eye is detected, the image will be processed to create a copy with reduced red-eye.

- 1 Display the desired picture.
- 2 Select **RED EYE REMOVAL** in the playback menu.
- 3 Press **MENU/OK**.



- Results vary depending on the scene and the camera's success in detecting faces.
- The amount of time needed to process the image varies with the number of faces detected.
- Red eye cannot be removed from pictures that have already been processed using red-eye removal, which are indicated by a  icon during playback.
- Red eye removal cannot be performed on RAW images.

## VOICE MEMO SETTING

Add a voice memo to the current photograph.

- 1 Select **ON** for **VOICE MEMO SETTING** in the playback menu.
- 2 Display a photo to which you wish to add a voice memo.
- 3 Press and hold the **Fn2** button to record the memo. Recording ends after 30 s or when you release the button.



- The new memo will be recorded over any existing memos.
- Voice memos cannot be added to protected pictures.
- Deleting the picture also deletes the memo.

### Playing Voice Memos

Pictures with voice memos are indicated by  icons during playback.

- To play a memo, select the picture and press the **Fn2** button.
- A progress bar will be displayed while the memo plays back.
- Volume can be adjusted by pressing **MENU/OK** to pause playback and then pressing the focus stick (focus lever) up or down to adjust the volume. Press **MENU/OK** again to resume playback. Volume can also be adjusted using **▣ SOUND SET-UP > PLAYBACK VOLUME**.

## RATING

Rate pictures using stars.

---

- 1 Select **RATING** in the playback menu.
- 2 Rotate the front command dial to choose a picture and the rear command dial to choose a rating of from 0 to 5 stars ("★").



- The focus stick (focus lever) can be used in place of the front command dial to choose a picture.
- The rating dialog can also be displayed by pressing the **AE-L/AF-L** button in single-frame, nine-frame, or hundred-frame playback.
- Use touch controls to zoom in or out.

**COPY**

Copy pictures between the cards in the first and second slots.

- 1 Select **COPY** in the playback menu.
- 2 Highlight one of the following options.

Option	Description
<b>SLOT1 → SLOT2</b>	Copy pictures from the card in the first slot to the card in the second slot.
<b>SLOT2 → SLOT1</b>	Copy pictures from the card in the second slot to the card in the first slot.

- 3 Press the focus stick (focus lever) right.
- 4 Highlight one of the following options and press **MENU/OK**.

Option	Description
<b>FRAME</b>	Copy selected pictures. Press the focus stick left or right to view pictures and press <b>MENU/OK</b> to copy the current picture.
<b>ALL FRAMES</b>	Copy all pictures.

- ⓘ • Copying ends when the destination is full.
- If you attempt to copy a file over 4 GB in size to a memory card with a capacity of 32 GB or less, copying will end and the file will not be copied.

## IMAGE TRANSFER ORDER

Select photos for upload to a paired smartphone or tablet.

- 1 Select **IMAGE TRANSFER ORDER > SELECT FRAMES** in the playback menu.
- 2 Highlight photos and press **MENU/OK** to select or deselect. Repeat until all the desired photos have been selected.
- 3 Press **DISP/BACK** to exit to playback.



If **ON** is selected for both **CONNECTION SETTING > Bluetooth SETTINGS > Bluetooth ON/OFF** and **AUTO IMAGE TRANSFER**, upload will begin shortly after you exit to playback or turn the camera off.



- Image transfer orders can contain a maximum of 999 pictures.
- The following cannot be selected for upload:
  - Protected pictures
  - Movies
  - RAW images
  - "Gift" pictures (pictures taken with other cameras)
- If **PAIRING/TRANSFER ORDER** is selected for **CONNECTION SETTING > GENERAL SETTINGS > Wi-Fi BUTTON SETTING**, the **IMAGE TRANSFER ORDER** dialog can be displayed by pressing the **Fn1** button.
- To remove upload marking from all pictures in the current order, select **IMAGE TRANSFER ORDER > RESET ORDER**.
- If **ON** is selected for **CONNECTION SETTING > Bluetooth SETTINGS > AUTO IMAGE TRANSFER**, photos will automatically be marked for upload as they are taken.

## WIRELESS COMMUNICATION

Connect to smartphones running the latest version of the FUJIFILM Camera Remote app. The smartphone can then be used to:

- Control the camera and take pictures remotely
- Receive pictures uploaded from the camera
- Browse the pictures on the camera and download selected pictures
- Upload location data to the camera



For downloads and other information, visit:

[http://app.fujifilm-dsc.com/en/camera\\_remote/](http://app.fujifilm-dsc.com/en/camera_remote/)

## SLIDE SHOW

View pictures in an automated slide show. Press **MENU/OK** to start and press the focus stick (focus lever) right or left to skip ahead or back. Press **DISP/BACK** at any time during the show to view on-screen help. The show can be ended at any time by pressing **MENU/OK**.





The camera will not turn off automatically while a slide show is in progress.

## PHOTOBOOK ASSIST

Create books from your favorite photos.

### Creating a Photobook

- 1 Select **NEW BOOK** for  **PLAY BACK MENU > PHOTOBOOK ASSIST**.
- 2 Scroll through the images and press the focus stick (focus lever) up to select or deselect. Press **MENU/OK** to exit when the book is complete.
  -  • Neither photographs **640** or smaller nor movies can be selected for photobooks.
  - The first picture selected becomes the cover image. Press the focus stick down to select the current image for the cover instead.
- 3 Highlight **COMPLETE PHOTOBOOK** and press **MENU/OK** (to select all photos for the book, choose **SELECT ALL**). The new book will be added to the list in the photobook assist menu.

-  • Books can contain up to 300 pictures.
- Books that contain no photos are automatically deleted.



## Viewing Photobooks

Highlight a book in the photobook assist menu and press **MENU/OK** to display the book, then press the focus stick (focus lever) left or right to scroll through the pictures.

## Editing and Deleting Photobooks

Display the photobook and press **MENU/OK**. The following options will be displayed; select the desired option and follow the on-screen instructions.

- **EDIT:** Edit the book as described in “Creating a Photobook”.
- **ERASE:** Delete the book.

## PC AUTO SAVE

Upload pictures from the camera to a computer running the latest version of FUJIFILM PC AutoSave (note that you must first install the software and configure the computer as a destination for images copied from the camera).



For downloads and other information, visit:

[http://app.fujifilm-dsc.com/en/pc\\_autosave/](http://app.fujifilm-dsc.com/en/pc_autosave/)

## PRINT ORDER (DPOF)

Create a digital “print order” for DPOF-compatible printers.

- 1 Select **PLAY BACK MENU > PRINT ORDER (DPOF)**.
- 2 Select **WITH DATE** to print the date of recording on pictures, **WITHOUT DATE** to print pictures without dates, or **RESET ALL** to remove all pictures from the print order before proceeding.
- 3 Display a picture you wish to include in or remove from the print order.
- 4 Press the focus stick (focus lever) up or down to choose the number of copies (up to 99).

To remove a picture from the order, press the focus stick down until the number of copies is 0.

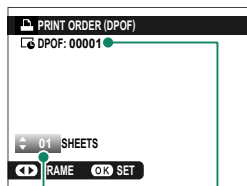

Total number  
of prints

Number of copies

Repeat steps 3–4 to complete the print order.

- 5 The total number of prints is displayed in the monitor. Press **MENU/OK** to exit.

- The pictures in the current print order are indicated by a icon during playback.
- Print orders can contain a maximum of 999 pictures from a single memory card.
- If a memory card is inserted containing a print order created by another camera, you will need to delete the order before creating as described above.

## instax PRINTER PRINT

To print pictures to optional Fujifilm instax SHARE printers, first select **CONNECTION SETTING** > **instax PRINTER CONNECTION SETTING** and enter the instax SHARE printer name (SSID) and password, then follow the steps below.

- 1 Turn the printer on.
- 2 Select **PLAY BACK MENU** > **instax PRINTER PRINT**. The camera will connect to the printer.

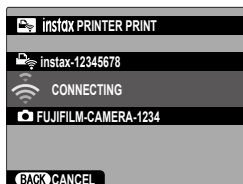

- 3 Use the focus stick (focus lever) to display the picture you want to print, then press **MENU/OK**. The picture will be sent to the printer and printing will start.



- Pictures taken with other cameras cannot be printed.
- The area printed is smaller than the area visible in the LCD monitor.
- The displays may vary depending on the printer connected.



# The Setup Menus

# 8

## USER SETTING

Adjust basic camera settings.

To access basic camera settings, press **MENU/OK**, select the **SET UP** tab, and choose **USER SETTING**.

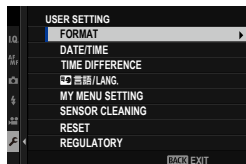

## FORMAT

To format a memory card:

- 1 Select **USER SETTING > FORMAT** in the **SET UP** tab.
- 2 Highlight the slot containing the card you wish to format and press **MENU/OK**.
- 3 A confirmation dialog will be displayed. To format the memory card, highlight **OK** and press **MENU/OK**.

To exit without formatting the memory card, select **CANCEL** or press **DISP/BACK**.

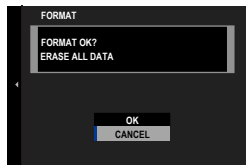



- All data—including protected pictures—will be deleted from the memory card. Be sure important files have been copied to a computer or other storage device.
- Do not open the battery-chamber cover during formatting.

The format menu can also be displayed by pressing the center of the rear command dial while pressing and holding the **DRIVE** button.

## DATE/TIME



To set the camera clock:



- 1 Select  **USER SETTING** > **DATE/TIME** in the  (**SET UP**) tab.
- 2 Press the focus stick (focus lever) left or right to highlight the year, month, day, hour, or minute and press up or down to change. To change the order in which the year, month, and day are displayed, highlight the date format and press the focus stick up or down.
- 3 Press **MENU/OK** to set the clock.



## TIME DIFFERENCE

Switch the camera clock instantly from your home time zone to the local time at your destination when traveling. To specify the difference between your local and home time zone:

- 1 Highlight  **LOCAL** and press **MENU/OK**.
- 2 Use the focus stick (focus lever) to choose the time difference between local time and your home time zone. Press **MENU/OK** when settings are complete.

To set the camera clock to local time, highlight  **LOCAL** and press **MENU/OK**. To set the clock to the time in your home time zone, select  **HOME**.

Options	
 <b>LOCAL</b>	 <b>HOME</b>

 If  **LOCAL** is selected,  will be displayed in yellow for about three seconds when the camera is turned on.

Choose a language.

## MY MENU SETTING

Edit the items listed in the **MY** (MY MENU) tab, a personalized custom menu of frequently-used options.

- 1 Highlight **USER SETTING > MY MENU SETTING** in the **(SET UP)** tab and press **MENU/OK**.

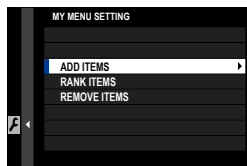

To reorder items, select **RANK ITEMS**. To delete items, select **REMOVE ITEMS**.

- 2 Press the focus stick (focus lever) up or down to highlight **ADD ITEMS** and press **MENU/OK**. Options that can be added to “my menu” are highlighted in blue.

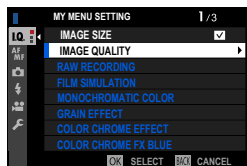

Items currently in “my menu” are indicated by check marks.

- 3 Choose a position for the item and press **MENU/OK**. The item will be added to “my menu”.

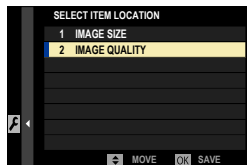

- 4 Press **MENU/OK** to return to the edit display.
- 5 Repeat Steps 3 and 4 until all the desired items have been added.

“My menu” can contain up to 16 items.



## SENSOR CLEANING

Remove dust from the camera image sensor.

Option	Description
<b>OK</b>	Clean the sensor immediately.
<b>WHEN SWITCHED ON</b>	Sensor cleaning will be performed when the camera is turned on.
<b>WHEN SWITCHED OFF</b>	Sensor cleaning will be performed when the camera turns off (sensor cleaning is not however performed if the camera turns off in playback mode).



Dust that cannot be removed using sensor cleaning can be removed using a blower (📖 301).

## RESET

Reset shooting or setup menu options to default values.

- 1 Highlight the desired option and press **MENU/OK**.

Option	Description
<b>SHOOTING MENU RESET</b>	Reset all shooting menu settings other than custom white balance and custom settings banks created using <b>EDIT/SAVE CUSTOM SETTING</b> to default values.
<b>SET-UP RESET</b>	Reset all setup menu settings other than <b>DATE/TIME</b> , <b>TIME DIFFERENCE</b> , <b>COPYRIGHT INFO</b> , and connection-related <b>CONNECTION SETTING</b> options to default values.

- 2 A confirmation dialog will be displayed; highlight **OK** and press **MENU/OK**.

## REGULATORY

To view electronic copies of the product model number, CMIIT ID, and other certificates, select **USER SETTING > REGULATORY** in the setup menu.

## SOUND SETTING

Make changes to camera sounds.

To access sound settings, press **MENU/OK**, select the **SET UP** tab, and choose **SOUND SET-UP**.

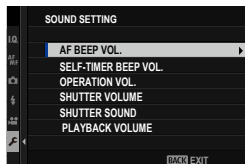

### AF BEEP VOL.

Choose the volume of the beep that sounds when the camera focuses. The beep can be muted by selecting **OFF**.

#### Options

(high)

(medium)

(low)

**OFF** (mute)

### SELF-TIMER BEEP VOL.

Choose the volume of the beep that sounds while the self-timer is active. The beep can be muted by selecting **OFF**.

#### Options

(high)

(medium)

(low)

**OFF** (mute)

**OPERATION VOL.**

Adjust the volume of the sounds produced when camera controls are operated. Choose OFF to disable control sounds.

**Options** (high) (medium) (low)OFF (mute)**SHUTTER VOLUME**

Adjust the volume of the sounds produced by the electronic shutter. Choose OFF to disable the shutter sound.

**Options** (high) (medium) (low)OFF (mute)**SHUTTER SOUND**

Choose the sound made by the electronic shutter.

**Options** 1 SOUND 1 2 SOUND 2 3 SOUND 3**PLAYBACK VOLUME**

Adjust the volume for movie playback.

**Options**

0

1

2

3

4

5

6

7

8

9

10

## SCREEN SETTING

Make changes to display settings.

To access display settings, press **MENU/OK**, select the **SET UP** (SET UP) tab, and choose **SCREEN SET-UP**.

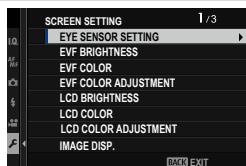

### EYE SENSOR SETTING

Turn the eye sensor on or off. Separate options are available for shooting and playback.

Option	Description
<b>SHOOTING</b>	<ul style="list-style-type: none"><li><b>ON:</b> Putting your eye to the EVF turns the EVF on. The LCD monitor turns off.</li></ul>
<b>PLAYBACK</b>	<ul style="list-style-type: none"><li><b>OFF:</b> The EVF turns on when the monitor panel is closed and off when the panel is open.</li></ul>

### EVF BRIGHTNESS

Adjust the brightness of the display in the electronic viewfinder.

Option	Description
<b>AUTO</b>	Automatic brightness adjustment.
<b>MANUAL</b>	Adjust brightness manually; choose from options between -7 and +5.

### EVF COLOR

Adjust the hue of the display in the electronic viewfinder.

Options										
-5	-4	-3	-2	-1	0	+1	+2	+3	+4	+5

## EVF COLOR ADJUSTMENT

Adjust the color of the display in the electronic viewfinder.

- 1 Adjust colors using the focus stick (focus lever).

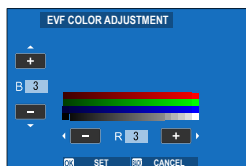

- 2 Press **MENU/OK**.

## LCD BRIGHTNESS

Adjust monitor brightness.

### Options

-5	-4	-3	-2	-1	0	+1	+2	+3	+4	+5
----	----	----	----	----	---	----	----	----	----	----

## LCD COLOR

Adjust monitor hue.

### Options

-5	-4	-3	-2	-1	0	+1	+2	+3	+4	+5
----	----	----	----	----	---	----	----	----	----	----

## LCD COLOR ADJUSTMENT

Adjust the color of the display in the LCD monitor.

- 1 Adjust colors using the focus stick (focus lever).
- 2 Press **MENU/OK**.

**IMAGE DISP.**

Choose how long images are displayed after shooting.

Option	Description
<b>CONTINUOUS</b>	Pictures are displayed until the <b>MENU/OK</b> button is pressed or the shutter button is pressed halfway. To zoom in on the active focus point, press the center of the rear command dial; press again to cancel zoom.
<b>1.5 SEC</b>	Pictures are displayed for the selected time or until the shutter button is pressed halfway.
<b>0.5 SEC</b>	
<b>OFF</b>	Pictures are not displayed after shooting.



- Colors may differ slightly from those in the final image.
- “Noise” mottling may be visible at high sensitivities.

**AUTOROTATE DISPLAYS**

Choose whether the indicators in the viewfinder and LCD monitor rotate to match camera orientation.

Options	
<b>ON</b>	<b>OFF</b>

## PREVIEW EXP./WB IN MANUAL MODE

Choose whether to enable exposure and/or white balance preview in manual exposure mode.

Option	Description
<b>PREVIEW EXP./WB</b>	Enable exposure and white balance preview.
<b>PREVIEW WB</b>	Preview white balance only. Choose this option in situations in which exposure and white balance are likely to change during shooting, as may be the case when you use a flash with an incandescent monitoring lamp.
<b>OFF</b>	Disable exposure and white balance preview. Choose this option when using a flash or on other occasions on which exposure may change when the picture is taken.

## NATURAL LIVE VIEW





Choose whether the effects of film simulation, white balance, and other settings are visible in the monitor.

Option	Description
<b>ON</b>	The effects of camera settings are not visible in the monitor, but shadows in low-contrast, back-lit scenes and other hard-to-see subjects more visible. Colors and tone will differ from those in the final picture. The display will however be adjusted to show the effects of monochrome and sepia settings.
<b>OFF</b>	The effects of film simulation, white balance, and other settings can be previewed in the monitor.

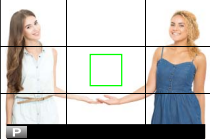
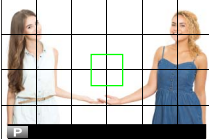

## FRAMING GUIDELINE

Choose a framing grid for shooting mode.

		Option		
		 GRID 9	 GRID 24	 HD FRAMING
Display				
	<i>For "rule of thirds" composition.</i>	<i>A six-by-four grid.</i>	<i>Frame HD pictures in the crop shown by the lines at the top and bottom of the display.</i>	

 Framing guides are not shown at default settings but can be displayed using **SCREEN SET-UP > DISP. CUSTOM SETTING** (📖 208).

## AUTOROTATE PB

Choose **ON** to automatically rotate “tall” (portrait-orientation) pictures during playback.

Options	
<b>ON</b>	<b>OFF</b>

## FOCUS SCALE UNITS

Choose the units used for the focus distance indicator.

Options	
<b>METERS</b>	<b>FEET</b>

## APERTURE UNIT FOR CINEMA LENS

Choose whether the camera displays aperture as a T-number (used for movie camera lenses) or an f/-number (used for still camera lenses) when an optional FUJINON MKX-series lens is attached. For information on using cinema lenses, see the documentation provided with the lens.

Option	Description
<b>T NUMBER</b>	A measure of lens aperture commonly used by cinematographers. Lens transmittance is taken into account to better calculate exposure.
<b>F NUMBER</b>	A measure of lens aperture commonly used by photographers. Lens transmittance is assumed to be 100%, meaning that the same aperture may produce different exposures depending on the lens.

## OVF, IMAGE DISP.

Choose how the camera displays pictures after shooting when the OVF is used. Pictures are displayed only for the length of time selected for  **SCREEN SET-UP > IMAGE DISP.**

Option	Description
<b>FULL SCREEN</b>	The pictures fill the viewfinder.
<b>SMALL WINDOW</b>	The pictures are displayed in the electronic rangefinder (ERF).

 **FULL SCREEN** is selected automatically when **CONTINUOUS** is chosen for  **SCREEN SET-UP > IMAGE DISP.** Pictures are not displayed after shooting when **OFF** is chosen.

## DISP. CUSTOM SETTING

Choose the items shown in the standard indicator display.

- 1 In shooting mode, use the **DISP/BACK** button to display standard indicators.
- 2 Press **MENU/OK** and select **SCREEN SET-UP > DISP. CUSTOM SETTING** in the **(SET UP)** tab.
- 3 Choose **OVF** or **EVF/LCD**.
- 4 Highlight items and press **MENU/OK** to select or deselect.
- 5 Press **DISP/BACK** to save changes.
- 6 Press **DISP/BACK** as needed to exit the menus and return to the shooting display.

## Available Items

The items that can be displayed in the OVF or EVF/LCD monitor are as follows:

Item	Default	
	OVF	EVF/LCD
FRAMING GUIDELINE	<input type="checkbox"/>	<input type="checkbox"/>
ELECTRONIC LEVEL	<input type="checkbox"/>	<input type="checkbox"/>
FOCUS FRAME	<input checked="" type="checkbox"/>	<input checked="" type="checkbox"/>
AF DISTANCE INDICATOR	<input type="checkbox"/>	<input type="checkbox"/>
MF DISTANCE INDICATOR	<input checked="" type="checkbox"/>	<input checked="" type="checkbox"/>
HISTOGRAM	<input type="checkbox"/>	<input type="checkbox"/>
LIVE VIEW HIGHLIGHT ALERT	—	<input type="checkbox"/>
SHOOTING MODE	<input checked="" type="checkbox"/>	<input checked="" type="checkbox"/>
APERTURE/S-SPEED/ISO	<input checked="" type="checkbox"/>	<input checked="" type="checkbox"/>
INFORMATION BACKGROUND	—	<input checked="" type="checkbox"/>
Expo. Comp. (Digit)	<input type="checkbox"/>	<input type="checkbox"/>
Expo. Comp. (Scale)	<input checked="" type="checkbox"/>	<input checked="" type="checkbox"/>
FOCUS MODE	<input checked="" type="checkbox"/>	<input checked="" type="checkbox"/>
PHOTOMETRY	<input checked="" type="checkbox"/>	<input checked="" type="checkbox"/>
SHUTTER TYPE	<input checked="" type="checkbox"/>	<input checked="" type="checkbox"/>
FLASH	<input checked="" type="checkbox"/>	<input checked="" type="checkbox"/>
CONTINUOUS MODE	<input checked="" type="checkbox"/>	<input checked="" type="checkbox"/>
DUAL IS MODE	<input checked="" type="checkbox"/>	<input checked="" type="checkbox"/>
TOUCH SCREEN MODE	—	<input checked="" type="checkbox"/>
WHITE BALANCE	<input checked="" type="checkbox"/>	<input checked="" type="checkbox"/>
FILM SIMULATION	<input checked="" type="checkbox"/>	<input checked="" type="checkbox"/>
DYNAMIC RANGE	<input checked="" type="checkbox"/>	<input checked="" type="checkbox"/>
BOOST MODE	<input checked="" type="checkbox"/>	<input checked="" type="checkbox"/>
FRAMES REMAINING	<input checked="" type="checkbox"/>	<input checked="" type="checkbox"/>
IMAGE SIZE/QUALITY	<input checked="" type="checkbox"/>	<input checked="" type="checkbox"/>
MOVIE MODE & REC. TIME	—	<input checked="" type="checkbox"/>
IMAGE TRANSFER ORDER	<input checked="" type="checkbox"/>	<input checked="" type="checkbox"/>
MIC LEVEL	—	<input checked="" type="checkbox"/>
GUIDANCE MESSAGE	<input checked="" type="checkbox"/>	<input checked="" type="checkbox"/>
BATTERY LEVEL	<input checked="" type="checkbox"/>	<input checked="" type="checkbox"/>
FRAMING OUTLINE	—	<input type="checkbox"/>

## LARGE INDICATORS MODE(EVF/OVF)

Select **ON** to display large indicators in the optical or electronic viewfinder. The indicators displayed can be selected using **SCREEN SET-UP > LARGE INDICATORS DISP. SETTING**.

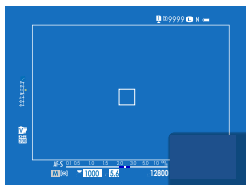

OFF

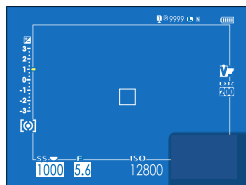

ON

Some icons are not displayed when **ON** is selected for **LARGE INDICATORS MODE(EVF/OVF)** (13).

If **LARGE INDICATORS MODE** is assigned to a function button, the button can be used to toggle **LARGE INDICATORS MODE** on (**ON**) and off (**OFF**) (216, 248).

## LARGE INDICATORS MODE(LCD)

Select **ON** to display large indicators in the LCD monitor. The indicators displayed can be selected using **SCREEN SET-UP > LARGE INDICATORS DISP. SETTING**.



OFF

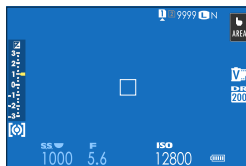

ON

Some icons are not displayed when **ON** is selected for **LARGE INDICATORS MODE(LCD)** (15).

If **LARGE INDICATORS MODE** is assigned to a function button, the button can be used to toggle **LARGE INDICATORS MODE** on (**ON**) and off (**OFF**) (216, 248).

## LARGE INDICATORS DISP. SETTING

Choose the indicators displayed when **ON** is selected for **SCREEN SET-UP > LARGE INDICATORS MODE(EVF/OVF)** or **LARGE INDICATORS MODE(LCD)**.

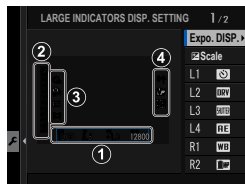

Option	Description
① <b>Expo. DISP.</b>	Choose the items listed at the bottom of the display. Selected items are indicated by check marks (✓); to deselect, highlight the check marks and press <b>MENU/OK</b> .
② <b>Scale</b>	Select <b>ON</b> to display the exposure indicator.
③ <b>L1, L2, L3, L4</b>	Choose up to four large icons for display on the left side of the screen.
④ <b>R1, R2, R3, R4</b>	Choose up to four large icons for display on the right side of the screen.

## INFORMATION CONTRAST ADJ.

Adjust display contrast.

Option	Description
<b>HIGH CONTRAST</b>	High contrast.
<b>STANDARD</b>	Normal contrast.
<b>LOW CONTRAST</b>	Low contrast.
<b>DARK AMBIENT LIGHTING</b>	Contrast adjusted for dim ambient lighting.

## SUB MONITOR

Adjust display settings for the sub monitor. Separate displays are available for still photography and movie recording. Choose from the following:

Option	Description
<b>CLASSIC</b>	Display the settings chosen for film simulation, white balance, and ISO sensitivity.
<b>STANDARD</b>	Display camera settings. You can choose the settings displayed.

### Choosing the Items Displayed in STANDARD Mode

Follow the steps below to choose the indicators shown in the **STANDARD** display.

- 1 Select **SCREEN SET-UP > SUB MONITOR** in the setup menu.
- 2 Highlight **STANDARD** and press **MENU/OK**.
- 3 Highlight **STILL MODE** or **MOVIE MODE** and press **MENU/OK**.
- 4 Highlight the indicator you wish to change and press **MENU/OK**.

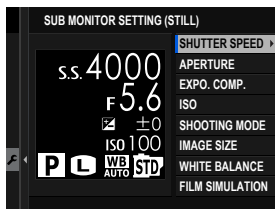



- 5 Highlight the indicator you wish to display and press **MENU/OK**.

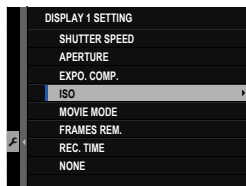

**Choose from:**

- SHUTTER SPEED
- APERTURE
- EXPO. COMP.
- ISO
- MOVIE MODE
- FRAMES REM.
- REC. TIME
- SHOOTING MODE
- PHOTOMETRY
- DRIVE MODE
- FOCUS MODE
- WHITE BALANCE
- IMAGE SIZE
- IMAGE QUALITY
- BATTERY LEVEL
- CARD SLOT OPTIONS
- SHUTTERTYPE
- FILM SIMULATION
- DYNAMIC RANGE
- NONE

- 6 Repeat Steps 4 and 5 to change additional indicators.

## BUTTON/DIAL SETTING

Access options for camera controls.

To access control options, press **MENU/OK**, select the **SET UP** tab, and choose **BUTTON/DIAL SETTING**.

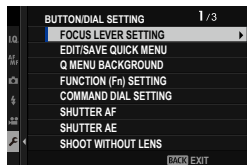



## FOCUS LEVER SETTING

Choose the functions performed by the focus stick (focus lever).

Option	Description
<b>LOCK (OFF)</b>	The focus stick cannot be used during shooting.
<b>PUSH  TO UNLOCK</b>	Press the stick to view the focus-point display and tilt the stick to select a focus point.
<b>ON</b>	Tilt the stick to view the focus-point display and select a focus point.

## EDIT/SAVE QUICK MENU

Choose the items displayed in the quick menu.

- 1 Select  **BUTTON/DIAL SETTING > EDIT/SAVE QUICK MENU** in the  (**SET UP**) tab.
- 2 Choose the number of items displayed in the quick menu. Quick menu save/edit options will be displayed.
- 3 Highlight the item you wish to change and press **MENU/OK**. The following can be assigned to the quick menu.
 

<ul style="list-style-type: none"> <li>• IMAGE SIZE</li> <li>• IMAGE QUALITY</li> <li>• FILM SIMULATION</li> <li>• GRAIN EFFECT</li> <li>• COLOR CHROME EFFECT</li> <li>• COLOR CHROME FX BLUE</li> <li>• DYNAMIC RANGE</li> <li>• D RANGE PRIORITY</li> <li>• WHITE BALANCE</li> <li>• HIGHLIGHT TONE</li> <li>• SHADOW TONE</li> <li>• COLOR</li> <li>• SHARPNESS</li> <li>• CLARITY</li> <li>• NOISE REDUCTION</li> <li>• SELECT CUSTOM SETTING</li> <li>• AF MODE (MOVIE AF MODE)</li> </ul>	<ul style="list-style-type: none"> <li>• AF-C CUSTOM SETTINGS</li> <li>• FACE/EYE DETECTION SETTING</li> <li>• MF ASSIST</li> <li>• TOUCH SCREEN MODE</li> <li>• SELF-TIMER</li> <li>• PHOTOMETRY</li> <li>• SHUTTER TYPE</li> <li>• FLICKER REDUCTION</li> <li>• FLASH FUNCTION SETTING</li> <li>• FLASH COMPENSATION</li> <li>• MOVIE MODE</li> <li>• FULL HD HIGH SPEED REC</li> <li>• INTERNAL/EXTERNAL MIC LEVEL ADJUSTMENT</li> <li>• EVF/LCD BRIGHTNESS</li> <li>• EVF/LCD COLOR</li> <li>• NONE</li> </ul>
--	--

-  • Select **NONE** to assign no option to the selected position.
- When **SELECT CUSTOM SETTING** is selected, current settings are shown in the quick menu by the label **BASE**.

- 4 Highlight the desired option and press **MENU/OK**. The selected option will be assigned to the quick menu.

 The quick menu can also be accessed in shooting mode by holding the **Q** button.



## Q MENU BACKGROUND

Choose **TRANSPARENT** for a transparent background.

Options	
<b>TRANSPARENT</b>	<b>BLACK</b>

## FUNCTION (Fn) SETTING

Choose the roles played by the function buttons.

- 1 Select  **BUTTON/DIAL SETTING** > **FUNCTION (Fn) SETTING** in the  (**SET UP**) tab.
- 2 Highlight the desired control and press **MENU/OK**.
- 3 Highlight any of the following options and press **MENU/OK** to assign it to the selected control.



- **AE LOCK ONLY**, **AF LOCK ONLY**, **AE/AF LOCK**, **AF-ON**, and **AWB LOCK ONLY** cannot be assigned to the touch function buttons (**T-Fn1** through **T-Fn4**).
- Function button assignment options can also be accessed by holding the **DISP/BACK** button.

## Roles That Can Be Assigned to the Function Buttons

### Choose from:

- IMAGE SIZE
- IMAGE QUALITY
- RAW
- FILM SIMULATION
- GRAIN EFFECT
- COLOR CHROME EFFECT
- COLOR CHROME FX BLUE
- DYNAMIC RANGE
- D RANGE PRIORITY
- WHITE BALANCE
- CLARITY
- SELECT CUSTOM SETTING
- FOCUS AREA
- FOCUS CHECK
- AF MODE
- AF-C CUSTOM SETTINGS
- FACE SELECT 
- FACE DETECTION ON/OFF\*
- AF RANGE LIMITER
- SPORTS FINDER MODE
- PRE-SHOT **ES** 
- SELF-TIMER
- AE BKT SETTING
- FOCUS BKT SETTING
- PHOTOMETRY
- SHUTTER TYPE
- FLICKER REDUCTION
- ISO AUTO SETTING
- BRIGHT FRAME BRIGHTNESS
- IS MODE
- WIRELESS COMMUNICATION
- FLASH FUNCTION SETTING
- TTL-LOCK
- MODELING FLASH
- FULL HD HIGH SPEED REC
- ZEBRA SETTING
- INTERNAL/EXTERNAL MIC LEVEL ADJUSTMENT
- MOVIE SILENT CONTROL
- EYE SENSOR SETTING
- PREVIEW DEPTH OF FIELD
- PREVIEW EXP/WB IN MANUAL MODE
- NATURAL LIVE VIEW
- HISTOGRAM
- ELECTRONIC LEVEL
- LARGE INDICATORS MODE
- FRONT COMMAND DIAL SWITCH
- AE LOCK ONLY
- AF LOCK ONLY
- AE/AF LOCK
- AF-ON
- AWB LOCK ONLY
- LOCK SETTING
- PERFORMANCE
- AUTO IMAGE TRANSFER
- SELECT PAIRING DESTINATION
- Bluetooth ON/OFF
- QUICK MENU
- PLAYBACK
- NONE (control disabled)

\* Selection via the function buttons is not available when the OVF is displayed.

## AF-ON

If **AF-ON** is selected, you can press the control instead of keeping the shutter button pressed halfway.

## MODELING FLASH

If **MODELING FLASH** is selected when a compatible shoe-mounted flash unit is attached, you can press the control to test-fire the flash and check for shadows and the like (modeling flash).

## TTL-LOCK

If **TTL-LOCK** is selected, you can press the control to lock flash output according to the option selected for **FLASH SETTING > TTL-LOCK MODE** (📖 150).

## FACE SELECT ⚙️

**FACE SELECT** ⚙️ can be enabled or disabled by pressing the button to which **FACE SELECT** ⚙️ is assigned.

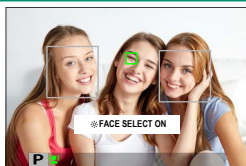

Enabling **FACE SELECT** ⚙️ allows the focus stick (focus lever) to be used to select the face that will be used for focus. To switch from face-detection to manual focus-area selection (📖 72), press the center of the focus stick (focus lever). Press again to re-enable face detection.

## COMMAND DIAL SETTING



Choose the roles played by the command dials.

Option	Description
<b>FRONT COMMAND DIAL 1</b>	Assign shutter speed ( <b>S.S. (PROGRAM SHIFT)</b> ) or aperture ( <b>APERTURE</b> ) <sup>1</sup> to <b>FRONT COMMAND DIAL 1</b> .
<b>FRONT COMMAND DIAL 2</b>	Assign shutter speed ( <b>S.S. (PROGRAM SHIFT)</b> ), aperture ( <b>APERTURE</b> ) <sup>1</sup> , exposure compensation ( <b>EXP. COMPENSATION</b> ) <sup>2</sup> , sensitivity ( <b>ISO</b> ) <sup>3</sup> , or no role ( <b>NONE</b> ) to <b>FRONT COMMAND DIAL 2</b> or <b>FRONT COMMAND DIAL 3</b> .
<b>FRONT COMMAND DIAL 3</b>	
<b>REAR COMMAND DIAL</b>	Assign shutter speed ( <b>S.S. (PROGRAM SHIFT)</b> ), aperture ( <b>APERTURE</b> ) <sup>1</sup> , exposure compensation ( <b>EXP. COMPENSATION</b> ) <sup>2</sup> , sensitivity ( <b>ISO</b> ) <sup>3</sup> , or no role ( <b>NONE</b> ) to the rear command dial.

1 Aperture set to **A** (auto) and lens equipped with aperture ring or **COMMAND** selected for  **BUTTON/DIAL SETTING** > **APERTURE RING SETTING (A)**.

2 Exposure compensation dial rotated to **C**.

3 **C** selected for sensitivity.

-  You can also press the **Fn2** button to cycle through settings in the order **FRONT COMMAND DIAL 1**, **FRONT COMMAND DIAL 2**, and **FRONT COMMAND DIAL 3**.
- The **Fn2** button can be assigned other roles using  **BUTTON/DIAL SETTING** > **FUNCTION (Fn) SETTING**. **FRONT COMMAND DIAL SWITCH** can also be assigned to other function buttons ( 248).

## SHUTTER AF

Choose whether the camera focuses when the shutter button is pressed halfway.

Option	Description
AF-S	<ul style="list-style-type: none"> <li>• <b>ON:</b> Focus locks when the shutter button is pressed halfway.</li> <li>• <b>OFF:</b> No focus operation is performed when the shutter button is pressed halfway.</li> </ul>
AF-C	<ul style="list-style-type: none"> <li>• <b>ON:</b> The camera focuses while the shutter button is pressed halfway.</li> <li>• <b>OFF:</b> No focus operation is performed when the shutter button is pressed halfway.</li> </ul>

## SHUTTER AE

If **ON** is selected, exposure will lock while the shutter button is pressed halfway.

Option	Description
AF-S/MF	<ul style="list-style-type: none"> <li>• <b>ON:</b> Exposure locks when the shutter button is pressed halfway.</li> <li>• <b>OFF:</b> Exposure does not lock when the shutter button is pressed halfway.</li> </ul>
AF-C	<ul style="list-style-type: none"> <li>• <b>ON:</b> Exposure locks while the shutter button is pressed halfway.</li> <li>• <b>OFF:</b> Exposure does not lock when the shutter button is pressed halfway.</li> </ul>

 Select **OFF** to allow the camera to adjust exposure before each shot taken in burst mode.



## SHOOT WITHOUT LENS

Choose **ON** to enable the shutter release when no lens is attached.

Options	
<b>ON</b>	<b>OFF</b>

## SHOOT WITHOUT CARD

Choose whether the shutter can be released without a memory card inserted in the camera.

Option	Description
<b>ON</b>	When no memory card is inserted, the shutter can be released to test camera function and the shooting and setup menus can be displayed.
<b>OFF</b>	The shutter is disabled if no memory card is inserted, preventing accidental loss of pictures taken without a memory card.

## FOCUS RING

Choose the direction in which the focus ring is rotated to increase the focus distance.

Options	
 <b>CW</b> (clockwise)	 <b>CCW</b> (counterclockwise)

## FOCUS RING OPERATION

Choose how the camera adjusts focus in response to the movement of the focus ring.

Option	Description
<b>NONLINEAR</b>	Focus is adjusted at the same rate as the ring is rotated.
<b>LINEAR</b>	Focus is adjusted linearly according to the amount the ring is rotated, but the focusing speed is unaffected by the speed the ring is rotated.

## AE/AF-LOCK MODE

This option determines the behavior of the button to which exposure and/or focus lock is assigned.

Option	Description
<b>AE&amp;AF ON WHEN PRESSING</b>	Exposure and/or focus will lock while the button is pressed.
<b>AE&amp;AF ON/OFF SWITCH</b>	Exposure and/or focus will lock when the button is pressed and remain locked until it is pressed again.

## AWB-LOCK MODE

Choose the behavior of function buttons assigned auto white balance (AWB) lock. Auto white balance lock is used to lock white balance at the value metered by the camera when **AUTO** is selected for white balance.

Option	Description
<b>AWB ON WHEN PRESSING</b>	Auto white balance locks while the button is pressed.
<b>AWB ON/OFF SWITCH</b>	Press the button once to lock auto white balance and again to end the lock.

## APERTURE RING SETTING (A)

Choose whether the front command dial can be used to adjust aperture when aperture is set to **A** (auto).

Option	Description
<b>AUTO</b>	The camera adjusts aperture automatically.
<b>COMMAND</b>	Aperture can be adjusted using the front command dial.





## APERTURE SETTING

Choose the method used to adjust aperture when using lenses with no aperture rings.

Option	Description
<b>AUTO +</b>  <b>MANUAL</b>	Rotate the front command dial to choose the aperture. Rotate past minimum aperture to choose <b>A</b> (auto).
<b>AUTO</b>	Aperture is selected automatically; camera functions in exposure mode <b>P</b> (program AE) or <b>S</b> (shutter-priority AE).
<b>MANUAL</b>	Rotate the front command dial to choose the aperture; camera functions in exposure mode <b>A</b> (aperture-priority AE) or <b>M</b> (manual).

## TOUCH SCREEN SETTING

Enable or disable touch-screen controls.

Option	Description
 <b>TOUCH SCREEN SETTING</b>	<ul style="list-style-type: none"> <li>• <b>ON</b>: The LCD monitor functions as a touch screen during shooting.</li> <li>• <b>OFF</b>: Touch controls disabled.</li> </ul>
 <b>DOUBLE TAP SETTING</b>	<ul style="list-style-type: none"> <li>• <b>ON</b>: Tap the LCD monitor twice to zoom in on your subject during shooting.</li> <li>• <b>OFF</b>: Touch zoom disabled.</li> </ul>
 <b>TOUCH FUNCTION</b>	Enable or disable touch function gestures.
 <b>TOUCH SCREEN SETTING</b>	<ul style="list-style-type: none"> <li>• <b>ON</b>: The LCD monitor functions as a touch screen during playback.</li> <li>• <b>OFF</b>: Touch controls disabled.</li> </ul>

## LOCK

Lock selected controls to prevent unintended operation.

Option	Description
<b>LOCK SETTING</b>	Choose from the following: <ul style="list-style-type: none"> <li>• <b>UNLOCK</b>: Reset lock options.</li> <li>• <b>ALL FUNCTION</b>: Lock all controls in the <b>FUNCTION SELECTION</b> list.</li> <li>• <b>SELECTED FUNCTION</b>: Lock only the controls selected in the <b>FUNCTION SELECTION</b> list.</li> </ul>
<b>FUNCTION SELECTION</b>	Choose the controls locked when <b>SELECTED FUNCTION</b> is chosen for <b>LOCK SETTING</b> .

 The controls selected using **SELECTED FUNCTION** can be locked at any time during shooting by pressing and holding **MENU/OK**. To unlock the controls, press and hold the button again.

## POWER MANAGEMENT

Adjust power management settings.

To access power management settings, press **MENU/OK**, select the **SET UP** tab, and choose **POWER MANAGEMENT**.

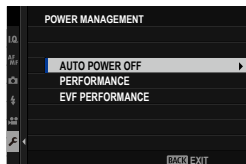

### AUTO POWER OFF

Choose the length of time before the camera turns off automatically when no operations are performed. Shorter times increase battery life; if **OFF** is selected, the camera must be turned off manually.

Options					
5 MIN	2 MIN	1 MIN	30 SEC	15 SEC	OFF

## PERFORMANCE

Select **BOOST** to improve focus and viewfinder display performance.

Option	Description
<b>BOOST</b>	Boost camera focus and viewfinder display performance. The battery drains faster than when is <b>NORMAL</b> selected.
<b>NORMAL</b>	Choose for standard focus and viewfinder display performance and battery endurance.

## EVF PERFORMANCE

Choose whether the EVF prioritizes **BRIGHTNESS PRIORITY** or **SMOOTHNESS PRIORITY**.

Option	Description
<b>BRIGHTNESS PRIORITY</b>	The EVF display prioritizes brightness. Recommended in most situations.
<b>SMOOTHNESS PRIORITY</b>	Minimize ghosting in the EVF display. Choose when photographing moving subjects. The brightness of the EVF may drop.

 **SMOOTHNESS PRIORITY** is only available when **BOOST** is selected for **PERFORMANCE**.

## SAVE DATA SETTING

Make changes to file management settings.

To access file management settings, press **MENU/OK**, select the **⌘ (SET UP)** tab, and choose **SAVE DATA SET-UP**.

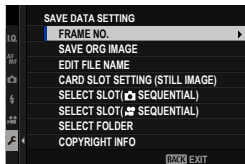

### FRAME NO.

New pictures are stored in image files named using a four-digit file number assigned by adding one to the last file number used. The file number is displayed during playback as shown. **FRAME NO.** controls whether file numbering is reset to 0001 when a new memory card is inserted or the current memory card is formatted.

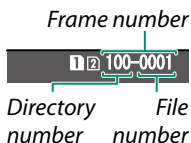

Option	Description
<b>CONTINUOUS</b>	Numbering continues from the last file number used or the first available file number, whichever is higher. Choose this option to reduce the number of pictures with duplicate file names.
<b>RENEW</b>	Numbering is reset to 0001 after formatting or when a new memory card is inserted.

- If the frame number reaches 999-9999, the shutter release will be disabled. Format the memory card after transferring to a computer any pictures you wish to keep.
- Selecting **⌘ USER SETTING > RESET** sets **FRAME NO.** to **CONTINUOUS** but does not reset the file number.
- Frame numbers for pictures taken with other cameras may differ.

## SAVE ORG IMAGE

Choose **ON** to save unprocessed copies of pictures taken using **RED EYE REMOVAL**.

Options	
<b>ON</b>	<b>OFF</b>

## EDIT FILE NAME

Change the file name prefix. sRGB images use a four-letter prefix (default "DSCF"), Adobe RGB images a three-letter prefix ("DSF") preceded by an underscore.

Option	Default prefix	Sample file name
sRGB	DSCF	ABCD0001
AdobeRGB	_DSF	_ABC0001

## CARD SLOT SETTING (STILL IMAGE)

Choose the role played by the card in the second slot.

Option	Description
<b>SEQUENTIAL</b>	The card in the second slot is used only when the card in the first slot is full.
<b>BACKUP</b>	Each picture is recorded twice, once to each card.
<b>RAW / JPEG</b>	RAW pictures will be saved to the card in the first slot and JPEG pictures to the card in the second slot.



**SELECT SLOT (📷 SEQUENTIAL)**

Choose the card that is recorded to first when **SEQUENTIAL** is selected for **CARD SLOT SETTING (STILL IMAGE)**.

Options	
<b>SLOT 1</b>	<b>SLOT 2</b>

**SELECT SLOT (🎬 SEQUENTIAL)**

Choose the slot used to store movies.

Options	
<b>SLOT 1</b>	<b>SLOT 2</b>

**SELECT FOLDER**

Create folders and choose the folder used to store subsequent pictures.

Option	Description
<b>SELECT FOLDER</b>	To choose the folder in which subsequent pictures will be stored, press the focus stick (focus lever) up or down to highlight an existing folder and press <b>MENU/OK</b> .
<b>CREATE FOLDER</b>	Enter a five-character folder name to create a new folder in which to store subsequent pictures. The new folder will be created with the next picture you take and subsequent pictures will be stored in that folder.

## COPYRIGHT INFO

Copyright information, in the form of Exif tags, can be added to new images as they are taken. Changes to copyright information are reflected only in images taken after the changes are made.

Option	Description
<b>DISP COPYRIGHT INFO</b>	View the current copyright information.
<b>ENTER AUTHOR'S INFO</b>	Enter the creator's name.
<b>ENTER COPYRIGHT INFO</b>	Enter the name of the copyright holder.
<b>DELETE COPYRIGHT INFO</b>	Delete the current copyright information. This change applies only to images taken after this option is selected; copyright information recorded with existing images is not affected.

## CONNECTION SETTING

Adjust settings for connection to other devices.

To access connection settings, press **MENU/OK**, select the **SET UP** tab, and choose **CONNECTION SETTING**.

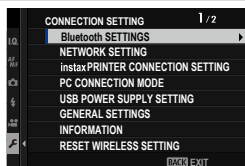

For more information on wireless connections, visit:  
<http://fujifilm-dsc.com/wifi/>

## Bluetooth SETTINGS

Adjust Bluetooth settings.

Option	Description
<b>PAIRING REGISTRATION</b>	To pair the camera with a smartphone or tablet, select this option, then launch FUJIFILM Camera Remote on the smart device and tap <b>PAIRING REGISTRATION</b> .
<b>SELECT PAIRING DESTINATION</b>	Choose a connection from a list of devices with which the camera has been paired using <b>PAIRING REGISTRATION</b> . Select <b>NO CONNECTION</b> to exit without connecting.
<b>DELETE PAIRING REG.</b>	Delete pairing information for selected devices. Choose the device in the device list. The selected device will also be removed from the devices listed in <b>SELECT PAIRING DESTINATION</b> .
<b>Bluetooth ON/OFF</b>	<ul style="list-style-type: none"><li>• <b>ON</b>: The camera automatically establishes a Bluetooth connection with paired devices when turned on.</li><li>• <b>OFF</b>: The camera does not connect via Bluetooth.</li></ul>
<b>AUTO IMAGE TRANSFER</b>	<ul style="list-style-type: none"><li>• <b>ON</b>: Mark photos for upload as they are taken. Mark JPEG photos for upload as they are taken.</li><li>• <b>OFF</b>: Photos are not marked for upload as they are taken.</li></ul>
<b>SMARTPHONE SYNC. SETTING</b>	Choose whether to synchronize the camera to the time and/or location provided by a paired smartphone. <ul style="list-style-type: none"><li>• <b>LOCATION&amp;TIME</b>: Synchronize the time and location.</li><li>• <b>LOCATION</b>: Synchronize the location.</li><li>• <b>TIME</b>: Synchronize the time.</li><li>• <b>OFF</b>: Synchronization off.</li></ul>



- Install the latest version of the FUJIFILM Camera Remote app on your smartphone or tablet before pairing the device with your camera or uploading images.
- When **ON** is selected for both **Bluetooth ON/OFF** and **AUTO IMAGE TRANSFER** or images are currently selected for upload using the **IMAGE TRANSFER ORDER** option in the  (playback) menu, upload to paired devices will begin shortly after you exit to playback or turn the camera off. **IMAGE TRANSFER ORDER** can also be used to select pictures for upload when **AUTO IMAGE TRANSFER** is off.

## NETWORK SETTING

Adjust settings for connection to wireless networks.

Option	Description
<b>WIRELESS ACCESS POINT SETTING</b>	<ul style="list-style-type: none"> <li>• <b>SIMPLE SETUP:</b> Connect to an access point using simple settings.</li> <li>• <b>MANUAL SETUP:</b> Manually adjust settings for connection to a wireless network. Choose the network from a list (<b>SELECT FROM NETWORK LIST</b>) or enter the name manually (<b>ENTER SSID</b>).</li> </ul>
<b>WIRELESS IP ADDRESS SETTING</b>	<ul style="list-style-type: none"> <li>• <b>AUTO:</b> The IP address is assigned automatically.</li> <li>• <b>MANUAL:</b> Assign an IP address manually. Manually choose the IP address (<b>IP ADDRESS</b>), network mask (<b>NETMASK</b>), and gateway address (<b>GATEWAY ADDRESS</b>).</li> </ul>

## PC AUTO SAVE

Adjust settings for connection to computers via wireless LAN.

Option	Description
<b>PC AUTO SAVE SETTING</b>	<p>Choose the method used for connection to computers via a wireless LAN.</p> <ul style="list-style-type: none"> <li>• <b>SIMPLE SETUP:</b> Connect using WPS.</li> <li>• <b>MANUAL SETUP:</b> Choose the network from a list (<b>SELECT FROM NETWORK LIST</b>) or enter the name manually (<b>ENTER SSID</b>).</li> </ul>
<b>DELETE REGISTERED DESTINATION PC</b>	Remove selected destinations.
<b>DETAILS OF PREVIOUS CONNECTION</b>	View computers to which the camera has recently connected.



## PC CONNECTION MODE

Adjust settings for connection to a computer.

Option	Description
<b>USB CARD READER</b>	Connecting the camera to a computer via USB automatically enables data transfer mode, allowing data to be copied to the computer. The camera functions normally when not connected.
<b>USB TETHER SHOOTING AUTO</b>	Connecting the camera to a computer via USB automatically enables tethered shooting mode. You can also use FUJIFILM X Acquire to save and load camera settings, allowing you to reconfigure the camera in an instant or share settings with other cameras of the same type. The camera functions normally when not connected.
<b>USB TETHER SHOOTING FIXED</b>	The camera functions in tethered shooting mode even when not connected to a computer. At default settings, pictures are not saved to the memory card, but pictures taken while the camera is not connected will be transferred to the computer when it is connected.
<b>WIRELESS TETHER SHOOTING FIXED</b>	Choose this option for wireless remote photography. Select a network using  <b>CONNECTION SETTING &gt; NETWORK SETTING</b> .
<b>USB RAW CONV./BACKUP RESTORE</b>	Connecting the camera to a computer via USB automatically enables USB RAW conversion/backup restore mode. The camera functions normally when not connected. <ul style="list-style-type: none"> <li>• <b>USB RAW CONV. (requires FUJIFILM X RAW STUDIO)</b>: Use the camera's image processing engine to rapidly convert RAW files to high-quality JPEG images.</li> <li>• <b>BACKUP RESTORE (requires FUJIFILM X Acquire)</b>: Save and load camera settings. Reconfigure the camera in an instant or share settings with other cameras of the same type.</li> </ul>

 **POWER MANAGEMENT > AUTO POWER OFF** settings also apply during tethered shooting. Select **OFF** to prevent the camera turning off automatically.

-  Tethered shooting is available with software such as Capture One Pro Fujifilm or Adobe® Photoshop® Lightroom® Classic CC. If you use Adobe® Photoshop® Lightroom® Classic CC, download FUJIFILM Tether Shooting Plug-in from the Adobe Exchange website. FUJIFILM Tether Shooting Plug-in is available free of charge.
- FUJIFILM X Acquire also supports tethered shooting using camera controls. FUJIFILM X Acquire can be downloaded free of charge from the Fujifilm website.

## USB POWER SUPPLY SETTING

Choose whether power is supplied to the camera when it is connected to a computer or other device via a USB cable.

Option	Description
<b>ON</b>	The camera draws power from the connected device, reducing the drain on the camera battery.
<b>OFF</b>	The camera does not draw power from the connected device.





 The camera cannot draw power from Lightning connections or from devices that do not supply power. Select **OFF** before connecting the camera to such devices. The connection may not be available for data transfer or the like when **ON** is selected.

-  The term “draw power” is used when the connected device supplies power to the camera.
- Regardless of the option chosen, the battery will charge while the camera is off.



## GENERAL SETTINGS

Adjust settings for connection to wireless networks.

Option	Description
<b>NAME</b>	Choose a name ( <b>NAME</b> ) to identify the camera on the wireless network (the camera is assigned a unique name by default).
<b>RESIZE IMAGE FOR SMARTPHONE</b> 	Choose whether to resize images for upload to smartphones. Resizing applies only to the copy uploaded to the smartphone; the original is not affected. <ul style="list-style-type: none"> <li>• <b>ON</b>: Larger images are resized to  for upload. This setting is recommended.</li> <li>• <b>OFF</b>: Images are uploaded at their original size.</li> </ul>
<b>GEOTAGGING</b>	Choose whether location data downloaded from a smartphone are embedded in pictures as they are taken.
<b>LOCATION INFO</b>	Display the location data last downloaded from a smartphone.
 <b>BUTTON SETTING</b>	Choose the role played by function buttons assigned the <b>WIRELESS COMMUNICATION</b> function. <ul style="list-style-type: none"> <li>•  <b>PAIRING/TRANSFER ORDER</b>: The buttons can be used for pairing and selecting images for transfer.</li> <li>•  <b>WIRELESS COMMUNICATION</b>: The buttons can be used for wireless connections.</li> </ul>

## INFORMATION

View the camera's MAC and Bluetooth address.

## RESET WIRELESS SETTING

Restore wireless settings to their default values.



# Shortcuts

# 9

## Shortcut Options

Customize camera controls to suit your style or situation.

Frequently-used options can be added to the **Q** menu or a custom “my” menu or assigned to an **Fn** (function) button for direct access:

Shortcut Option	Description	
<b>“My menu”</b>	Add frequently-used options to this custom menu, which can be viewed by pressing <b>MENU/OK</b> and selecting the <b>MY</b> (“MY MENU”) tab.	241
<b>The Q menu</b>	The <b>Q</b> menu is displayed by pressing the <b>Q</b> button. Use the <b>Q</b> menu to view or change the options selected for frequently-used menu items.	243
<b>The function buttons</b>	Use the function buttons for direct access to selected features.	246

## MY MENU

Access a personalized menu of frequently-used options.

To display “my menu”, press **MENU/OK** in the shooting display and select the **MY** (MY MENU) tab.



! The **MY** tab is only available if options have been assigned to **MY MENU**.

## MY MENU SETTING

To choose the items listed in the **MY** (MY MENU) tab:

- 1 Highlight **USER SETTING > MY MENU SETTING** in the **SET UP** tab and press **MENU/OK**.

To reorder items, select **RANK ITEMS**.  
To delete items, select **REMOVE ITEMS**.

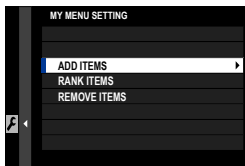

- 2 Press the focus stick (focus lever) up or down to highlight **ADD ITEMS** and press **MENU/OK**. Options that can be added to “my menu” are highlighted in blue.

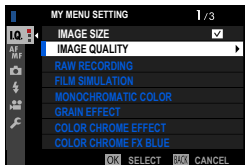

Items currently in “my menu” are indicated by check marks.

- 3 Choose a position for the item and press **MENU/OK**. The item will be added to “my menu”.

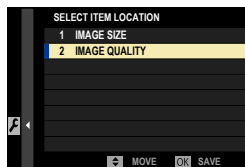

- 4 Press **MENU/OK** to return to the edit display.
- 5 Repeat Steps 3 and 4 until all the desired items have been added.

 “My menu” can contain up to 16 items.

## The Q (Quick Menu) Button

Press **Q** for quick access to selected options.

### The Quick Menu Display

At default settings, the quick menu contains the following items:

- Use **FUNCTION (Fn) SETTING** > **FUNCTION (Fn) SETTING** to choose the function performed by the **Q** (quick menu) button or assign its default function to other controls (248).
- To disable the **Q** (quick menu) button, select **NONE** for **FUNCTION (Fn) SETTING** > **Q BUTTON SETTING**.

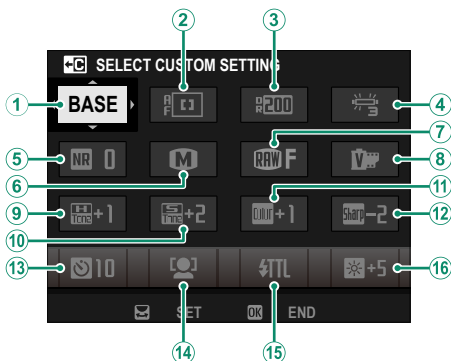

- |                         |                              |
|-------------------------|------------------------------|
| ① SELECT CUSTOM SETTING | ⑨ HIGHLIGHT TONE             |
| ② AF MODE               | ⑩ SHADOW TONE                |
| ③ DYNAMIC RANGE         | ⑪ COLOR                      |
| ④ WHITE BALANCE         | ⑫ SHARPNESS                  |
| ⑤ NOISE REDUCTION       | ⑬ SELF-TIMER                 |
| ⑥ IMAGE SIZE            | ⑭ FACE/EYE DETECTION SETTING |
| ⑦ IMAGE QUALITY         | ⑮ FLASH FUNCTION SETTING     |
| ⑧ FILM SIMULATION       | ⑯ EVF/LCD BRIGHTNESS         |

The quick menu shows the options currently selected for items ②–⑯, which can be changed as described on page 245.

## SELECT CUSTOM SETTING

The **Q** **IMAGE QUALITY SETTING > SELECT CUSTOM SETTING** item (item ①) shows the current custom settings bank:

- **BASE**: No custom settings bank selected.
- **C 1–C 7**: Select a bank to view the settings saved using the **Q** **IMAGE QUALITY SETTING > EDIT/SAVE CUSTOM SETTING** option.
- **BASE** **BASE** **C 1–C 7**: The current custom settings bank.

## Viewing and Changing Settings

- 1 Press **Q** to display the quick menu during shooting.

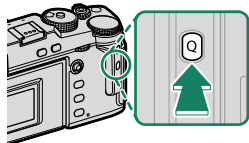

- 2 Use the focus stick (focus lever) to highlight items and rotate the rear command dial to change.

- Changes are not saved to the current settings bank.
- Settings that differ from those in the current settings bank (**C 1–C 7**) are shown in red.

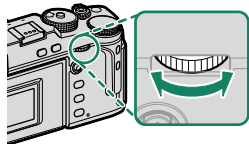
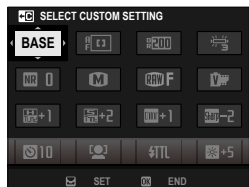

- 3 Press **Q** to exit when settings are complete.

 The quick menu can also be edited using touch controls.



## Editing the Quick Menu

To choose the items displayed in the quick menu:

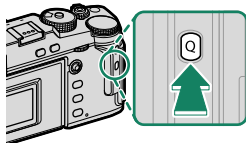

- 1 Press and hold the **Q** button during shooting.
- 2 The current quick menu will be displayed; use the focus stick (focus lever) to highlight the item you wish to change and press **MENU/OK**.



- 3 Highlight the item you wish to change and press **MENU/OK**. The following can be assigned to the quick menu.

- IMAGE SIZE
- IMAGE QUALITY
- FILM SIMULATION
- GRAIN EFFECT
- COLOR CHROME EFFECT
- COLOR CHROME FX BLUE
- DYNAMIC RANGE
- D RANGE PRIORITY
- WHITE BALANCE
- HIGHLIGHT TONE
- SHADOW TONE
- COLOR
- SHARPNESS
- CLARITY
- NOISE REDUCTION
- SELECT CUSTOM SETTING
- AF MODE (MOVIE AF MODE)
- AF-C CUSTOM SETTINGS
- FACE/EYE DETECTION SETTING
- MF ASSIST
- TOUCH SCREEN MODE
- SELF-TIMER
- PHOTOMETRY
- SHUTTER TYPE
- FLICKER REDUCTION
- FLASH FUNCTION SETTING
- FLASH COMPENSATION
- MOVIE MODE
- FULL HD HIGH SPEED REC
- INTERNAL/EXTERNAL MIC LEVEL ADJUSTMENT
- EVF/LCD BRIGHTNESS
- EVF/LCD COLOR
- NONE

-  • Select **NONE** to assign no option to the selected position.
- When **SELECT CUSTOM SETTING** is selected, current settings are shown in the quick menu by the label **BASE**.

-  The quick menu can also be edited using  **BUTTON/DIAL SETTING** > **EDIT/SAVE QUICK MENU**.

## The Fn (Function) Buttons

Assign a role to the function buttons for quick access to the selected feature.

- The functions assigned to **T-Fn1** through **T-Fn4** can be accessed by flicking the monitor.
- Touch-function gestures are disabled by default. To enable touch-function gestures, select **ON** for **▶ BUTTON/DIAL SETTING > TOUCH SCREEN SETTING >  TOUCH FUNCTION**.

The default assignments are:

### Touch-Function Gestures

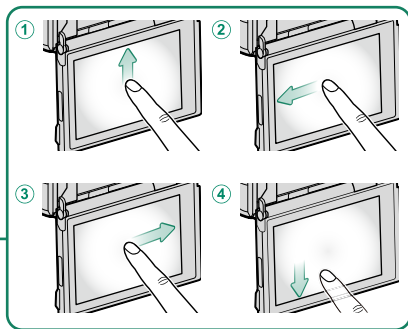
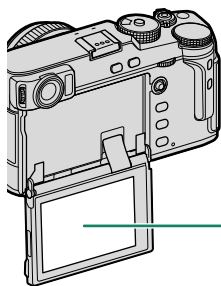

Function buttons	Default
① T-Fn1 (flick up)	HISTOGRAM
② T-Fn2 (flick left)	AF MODE
③ T-Fn3 (flick right)	WHITE BALANCE
④ T-Fn4 (flick down)	ELECTRONIC LEVEL

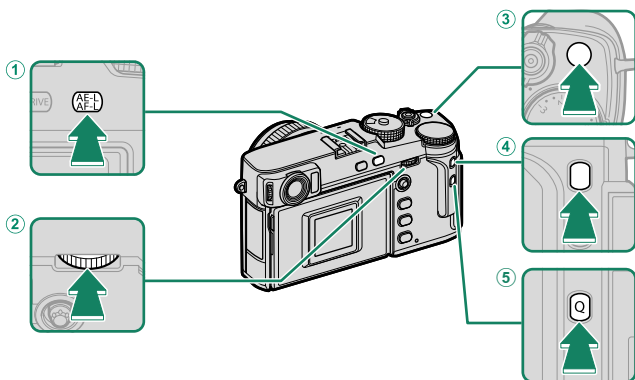
**Back-of-Camera Function Buttons**

Function buttons	Default
① AE-L/AF-L button	AE/AF LOCK
② Center of rear command dial	FOCUS CHECK
③ Fn1 button	PHOTOMETRY
④ Fn3 button	FILM SIMULATION
⑤ Q button	QUICK MENU

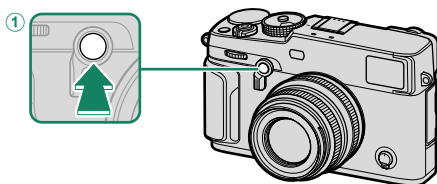
**Front-of-Camera Function Buttons**

Function buttons	Default
① Fn2 button	FRONT COMMAND DIAL SWITCH

## Assigning Roles to the Function Buttons

To assign roles to the buttons:

- 1 Press and hold the **DISP/BACK** button until a control selection menu is displayed.
- 2 Highlight the desired control and press **MENU/OK**.
- 3 Highlight any of the following options and press **MENU/OK** to assign it to the selected control.

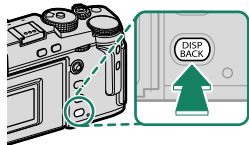

- **AE LOCK ONLY**, **AF LOCK ONLY**, **AE/AF LOCK**, **AF-ON**, and **AWB LOCK ONLY** cannot be assigned to the touch function buttons (**T-Fn1** through **T-Fn4**).
- Button assignments can also be selected using **FUNCTION (Fn) SETTING**.

## Roles That Can Be Assigned to the Function Buttons

### Choose from:

- IMAGE SIZE
- IMAGE QUALITY
- RAW
- FILM SIMULATION
- GRAIN EFFECT
- COLOR CHROME EFFECT
- COLOR CHROME FX BLUE
- DYNAMIC RANGE
- D RANGE PRIORITY
- WHITE BALANCE
- CLARITY
- SELECT CUSTOM SETTING
- FOCUS AREA
- FOCUS CHECK
- AF MODE
- AF-C CUSTOM SETTINGS
- FACE SELECT 
- FACE DETECTION ON/OFF \*
- AF RANGE LIMITER
- SPORTS FINDER MODE
- PRE-SHOT **ES** 
- SELF-TIMER
- AE BKT SETTING
- FOCUS BKT SETTING
- PHOTOMETRY
- SHUTTER TYPE
- FLICKER REDUCTION
- ISO AUTO SETTING
- BRIGHT FRAME BRIGHTNESS
- IS MODE
- WIRELESS COMMUNICATION
- FLASH FUNCTION SETTING
- TTL-LOCK
- MODELING FLASH
- FULL HD HIGH SPEED REC
- ZEBRA SETTING
- INTERNAL/EXTERNAL MIC LEVEL ADJUSTMENT
- MOVIE SILENT CONTROL
- EYE SENSOR SETTING
- PREVIEW DEPTH OF FIELD
- PREVIEW EXP/WB IN MANUAL MODE
- NATURAL LIVE VIEW
- HISTOGRAM
- ELECTRONIC LEVEL
- LARGE INDICATORS MODE
- FRONT COMMAND DIAL SWITCH
- AE LOCK ONLY
- AF LOCK ONLY
- AE/AF LOCK
- AF-ON
- AWB LOCK ONLY
- LOCK SETTING
- PERFORMANCE
- AUTO IMAGE TRANSFER
- SELECT PAIRING DESTINATION
- Bluetooth ON/OFF
- QUICK MENU
- PLAYBACK
- NONE (control disabled)

\* Selection via the function buttons is not available when the OVF is displayed.

## AF-ON

If **AF-ON** is selected, you can press the control instead of keeping the shutter button pressed halfway.

## MODELING FLASH

If **MODELING FLASH** is selected when a compatible shoe-mounted flash unit is attached, you can press the control to test-fire the flash and check for shadows and the like (modeling flash).

## TTL-LOCK

If **TTL-LOCK** is selected, you can press the control to lock flash output according to the option selected for **FLASH SETTING > TTL-LOCK MODE** (📖 150).

## FACE SELECT ⚙️

**FACE SELECT ⚙️** can be enabled or disabled by pressing the button to which **FACE SELECT ⚙️** is assigned.

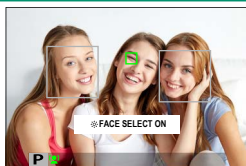

Enabling **FACE SELECT ⚙️** allows the focus stick (focus lever) to be used to select the face that will be used for focus. To switch from face-detection to manual focus-area selection (📖 72), press the center of the focus stick (focus lever). Press again to re-enable face detection.

# 10 Peripherals and Optional Accessories

## Lenses

The camera can be used with lenses for the FUJIFILM X-mount.

### Lens Parts

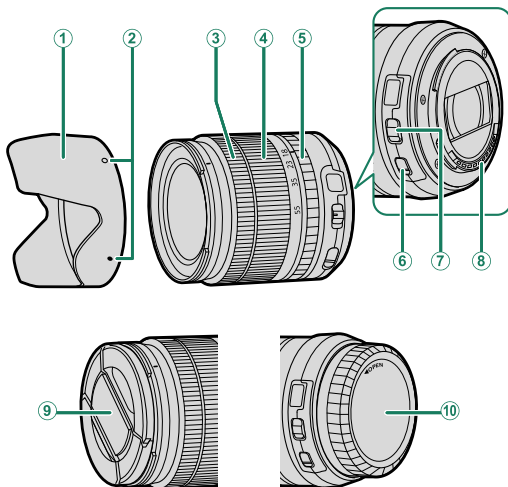

- ① Lens hood
- ② Mounting marks
- ③ Focus ring
- ④ Zoom ring
- ⑤ Aperture ring

- ⑥ O.I.S. switch
- ⑦ Aperture mode switch
- ⑧ Lens signal contacts
- ⑨ Front lens cap
- ⑩ Rear lens cap



## Removing Lens Caps

Remove lens caps as shown.

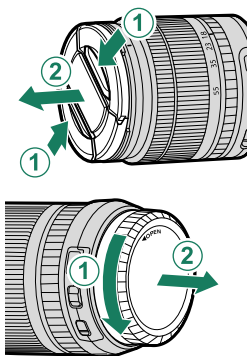

 Lens caps may differ from those shown.

## Attaching Lens Hoods

When attached, lens hoods reduce glare and protect the front lens element.

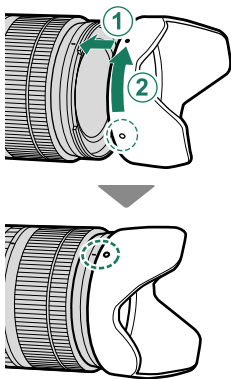

## Lenses with Aperture Rings

At settings other than **A**, you can adjust aperture by rotating the lens aperture ring (exposure modes **A** and **M**).

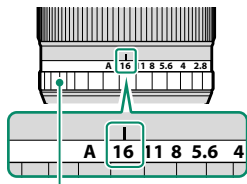

Aperture ring

When the aperture ring is set to **A**, rotate the command dials to adjust aperture (📖 219).

### The Aperture Mode Switch

If the lens has an aperture mode switch, aperture can be adjusted manually by sliding the switch to  and rotating the aperture ring.

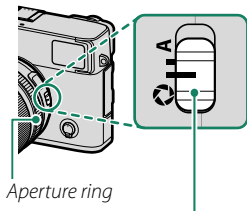

Aperture ring

Aperture mode switch

## Lenses with No Aperture Rings

The method used to adjust aperture can be selected using **FUNCTION/COMMAND DIAL SETTING > APERTURE SETTING**. When an option other than **AUTO** is selected, aperture can be adjusted using the front command dial.

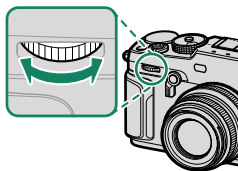

**NOTE** Aperture control defaults to the front command dial, but can be reassigned to the rear command dial using **FUNCTION/COMMAND DIAL SETTING > COMMAND DIAL SETTING**.

## Lenses with O.I.S. Switches

If the lens supports optical image stabilization (O.I.S.), the image stabilization mode can be chosen in the camera menu. To activate image stabilization, slide the O.I.S. switch to **ON**.

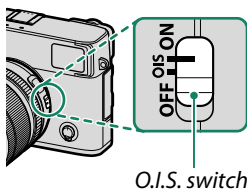

## Manual Focus Lenses

Slide the focus ring to the front for autofocus.

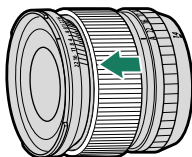

For manual focus, slide the focus ring to the back and rotate it while checking the results in the camera display. The focus distance and depth-of-field indicators can be used to assist manual focus.

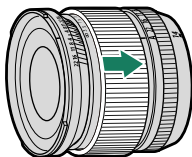

**!** Note that manual focus may not be available in all shooting modes.

### The Depth-of-Field Indicator

The depth-of-field indicator shows the approximate depth of field (the distance in front of and behind the focus point that appears to be in focus). The indicator is displayed in film format.

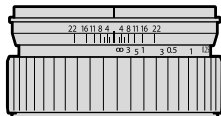

## Lens Care



- Use a blower to remove dust, then gently wipe with a soft, dry cloth. Any remaining stains can be removed by wiping gently with a piece of Fujifilm lens-cleaning paper to which a small amount of lens-cleaning fluid has been applied.
- Replace the front and rear caps when the lens is not in use.

## External Flash Units

Use optional external flash units for flash photography. Some units support high-speed sync (FP) and can be used at shutter speeds faster than the flash sync speed, while others can function as master flash units controlling remote units via optical wireless flash control.

 You may be unable to test-fire the flash in some circumstances, for example when a setup menu is displayed on the camera.

### Red-Eye Removal

Red-eye removal is available when an option other than **OFF** is selected for  **FLASH SETTING > RED EYE REMOVAL** and a **FACE DETECTION ON** option is selected for  **AF/MF SETTING > FACE/EYE DETECTION SETTING**. Red-eye removal minimizes “red-eye” caused when light from the flash is reflected from the subject’s retinas.

## Flash Settings

- 1 Connect the unit to the camera.
- 2 In shooting mode, select **FLASH FUNCTION SETTING** in the **FLASH SETTING** menu tab. The options available vary with the flash unit.

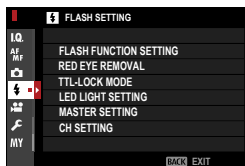

Menu	Description	
<b>SYNC TERMINAL</b>	Displayed when no compatible flash unit is connected or if the connected unit uses only the X-contact on the hot shoe.	260
<b>SHOE MOUNT FLASH</b>	Displayed when an optional flash unit is mounted on the hot shoe and turned on.	261
<b>MASTER (OPTICAL)</b>	Displayed if an optional flash unit functioning as a master flash for Fujifilm optical wireless remote flash control is connected and turned on.	264

 **SYNC TERMINAL** will be also displayed if an incompatible flash unit or no flash unit is connected.

- 3 Highlight items using the focus stick (focus lever) and rotate the rear command dial to change the highlighted setting.



- 4 Press **DISP/BACK** to put the changes into effect.

## SYNC TERMINAL

Displayed when no compatible flash unit is connected.

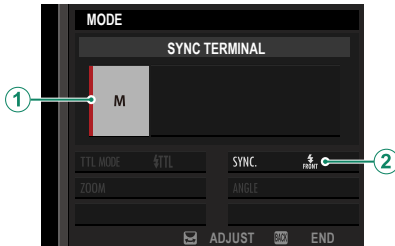

Setting	Description
① Flash control mode	Choose from the following options: <ul style="list-style-type: none"><li>• <b>M</b>: A trigger signal is transmitted via the hot shoe X contacts when a picture is taken. Choose a shutter speed slower than the sync speed; even slower speeds may be required if the unit uses long flashes or has a slow response time.</li><li>• <b>OFF (OFF)</b>: The trigger signal is disabled.</li></ul>
② Sync	Choose whether the flash is timed to fire immediately after the shutter opens ( <b>FRONT/1ST CURTAIN</b> ) or immediately before it closes ( <b>REAR/2ND CURTAIN</b> ). <b>1ST CURTAIN</b> is recommended in most circumstances.

### The Sync Terminal

Flash units requiring a sync cable connection cannot be used.







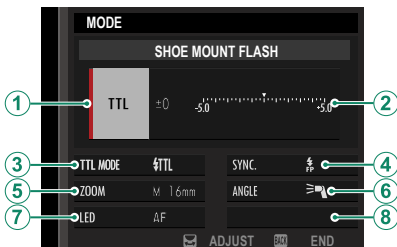

## SHOE MOUNT FLASH

The following options are available when an optional shoe-mounted flash unit is attached and turned on.



Setting	Description
① Flash control mode	<p>The flash control mode selected with the flash unit. This can in some cases be adjusted from the camera; the options available vary with the flash.</p> <ul style="list-style-type: none"> <li>• <b>TTL</b>: TTL mode. Adjust flash compensation (②).</li> <li>• <b>M</b>: The flash fires at the selected output regardless of subject brightness or camera settings. Output in some cases can be adjusted from the camera (②).</li> <li>• <b>MULTI</b>: Repeating flash. Compatible shoe-mounted flash units will fire multiple times with each shot.</li> <li>• <b>OFF (OFF)</b>: The flash does not fire. Some flash units can be turned off from the camera.</li> </ul>

Setting	Description
② Flash compensation/output	<p>The options available vary with flash control mode.</p> <ul style="list-style-type: none"> <li>• <b>TTL</b>: Adjust flash compensation (the full value may not be applied if the limits of the flash control system are exceeded). In the cases of the EF-X20, EF-20, EF-42, and EF-X500, the selected value is added to the value selected with the flash unit.</li> <li>• <b>M/MULTI</b>: Adjust flash output (compatible units only). Choose from values expressed as fractions of full power, from 1/4 (mode <b>M</b>) or 1/4 (<b>MULTI</b>) down to 1/512 in increments equivalent to 1/3 EV. The desired results may not be achieved at low values if they exceed the limits of the flash control system; take a test shot and check the results.</li> </ul>
③ Flash mode (TTL)	<p>Choose a flash mode for TTL flash control. The options available vary with the shooting mode (<b>P</b>, <b>S</b>, <b>A</b>, or <b>M</b>) selected.</p> <ul style="list-style-type: none"> <li>• <b>FLASH AUTO</b>: The flash fires only as required; flash level is adjusted according to subject brightness. A  icon displayed when the shutter button is pressed halfway indicates that the flash will fire when the photo is taken.</li> <li>• <b>STANDARD</b>: The flash fires with every shot if possible; flash level is adjusted according to subject brightness. The flash will not fire if not fully charged when the shutter is released.</li> <li>• <b>SLOW SYNC</b>: Combine the flash with slow shutter speeds when photographing portrait subjects against a backdrop of night scenery. The flash will not fire if not fully charged when the shutter is released.</li> </ul>
④ Sync	<p>Control flash timing.</p> <ul style="list-style-type: none"> <li>• <b>FRONT (1ST CURTAIN)</b>: The flash fires immediately after the shutter opens (generally the best choice).</li> <li>• <b>REAR (2ND CURTAIN)</b>: The flash fires immediately before the shutter closes.</li> <li>• <b>AUTO FP(HSS)</b>: High-speed sync (compatible units only). The camera automatically engages front-curtain high-speed sync at shutter speeds faster than the flash sync speed. Equivalent to <b>1ST CURTAIN</b> when <b>MULTI</b> is selected for flash control mode.</li> </ul>

Setting	Description
⑤ Zoom	The angle of illumination (flash coverage) for units that support flash zoom. Some units allow the adjustment to be made from the camera. If <b>AUTO</b> is selected, zoom will automatically be adjusted to match coverage to lens focal length.
⑥ Lighting	If the unit supports this feature, choose from: <ul style="list-style-type: none"> <li>•  (<b>FLASH POWER PRIORITY</b>): Gain range by slightly reducing coverage.</li> <li>•  (<b>STANDARD</b>): Match coverage to picture angle.</li> <li>•  (<b>EVEN COVERAGE PRIORITY</b>): Slightly increase coverage for more even lighting.</li> </ul>
⑦ LED light	Choose how the built-in LED light functions during still photography (compatible units only): as a catchlight (  / <b>CATCHLIGHT</b> ), as an AF-assist illuminator ( <b>AF/AF ASSIST</b> ), or as both a catchlight and an AF-assist illuminator (  / <b>AF ASSIST+CATCHLIGHT</b> ). Choose <b>OFF</b> to disable the LED during photography.
⑦ Number of flashes*	Choose the number of times the flash fires each time the shutter is released in <b>MULTI</b> mode.
⑧ Frequency*	Choose the frequency at which the flash fires in <b>MULTI</b> mode.

\* Full value may not be applied if limits of flash control system are exceeded.

## MASTER(OPTICAL)



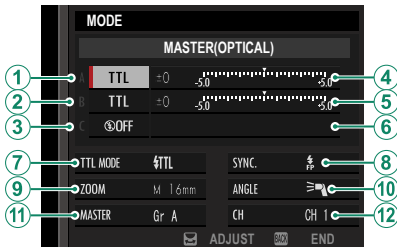

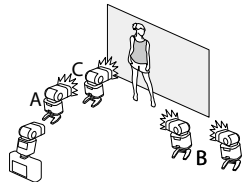

The options will be displayed if the unit is currently functioning as master flash for Fujifilm optical wireless remote flash control.





The master and remote units can be placed in up to three groups (A, B, and C) and flash mode and flash level adjusted separately for each group. Four channels are available for communication between the units; separate channels can be used for different flash systems or to prevent interference when multiple systems are operating in close proximity.



Setting	Description
① Flash control mode (group A)	<p>Choose flash control modes for groups A, B, and C. <b>TTL%</b> is available for groups A and B only.</p> <ul style="list-style-type: none"> <li>• <b>TTL</b>: The units in the group fire in TTL mode. Flash compensation can be adjusted separately for each group.</li> <li>• <b>TTL%</b>: If <b>TTL%</b> is selected for either group A or B, you can specify the output of the selected group as a percentage of the other and adjust overall flash compensation for both groups.</li> </ul>
② Flash control mode (group B)	<ul style="list-style-type: none"> <li>• <b>M</b>: In mode <b>M</b>, the units in the group fire at the selected output (expressed as a fraction of full power) regardless of subject brightness or camera settings.</li> </ul>
③ Flash control mode (group C)	<ul style="list-style-type: none"> <li>• <b>MULTI</b>: Choosing <b>MULTI</b> for any group sets all the units in all groups to repeating flash mode. All units will fire multiple times with each shot.</li> <li>• <b>OFF (OFF)</b>: If <b>OFF</b> is selected, the units in the group will not fire.</li> </ul>
④ Flash compensation/output (group A)	<p>Adjust flash level for the selected group according to option selected for flash control mode. Note that the full value may not be applied if the limits of the flash control system are exceeded.</p>
⑤ Flash compensation/output (group B)	<ul style="list-style-type: none"> <li>• <b>TTL</b>: Adjust flash compensation.</li> </ul>
⑥ Flash compensation/output (group C)	<ul style="list-style-type: none"> <li>• <b>M/MULTI</b>: Adjust flash output.</li> <li>• <b>TTL%</b>: Choose the balance between groups A and B and adjust overall flash compensation.</li> </ul>

Setting	Description
<p>7 Flash mode (TTL)</p>	<p>Choose a flash mode for TTL flash control. The options available vary with the shooting mode (<b>P</b>, <b>S</b>, <b>A</b>, or <b>M</b>) selected.</p> <ul style="list-style-type: none"> <li>  <b>(FLASH AUTO)</b>: The flash fires only as required; flash level is adjusted according to subject brightness. A  icon displayed when the shutter button is pressed halfway indicates that the flash will fire when the photo is taken.         </li> <li>  <b>(STANDARD)</b>: The flash fires with every shot if possible; flash level is adjusted according to subject brightness. The flash will not fire if not fully charged when the shutter is released.         </li> <li>  <b>(SLOW SYNC.)</b>: Combine the flash with slow shutter speeds when photographing portrait subjects against a backdrop of night scenery. The flash will not fire if not fully charged when the shutter is released.         </li> </ul>
<p>8 Sync</p>	<p>Control flash timing.</p> <ul style="list-style-type: none"> <li>  <b>(1ST CURTAIN)</b>: The flash fires immediately after the shutter opens (generally the best choice).         </li> <li>  <b>(2ND CURTAIN)</b>: The flash fires immediately before the shutter closes.         </li> <li>  <b>(AUTO FP(HSS))</b>: High-speed sync (compatible units only). The camera automatically engages front-curtain high-speed sync at shutter speeds faster than the flash sync speed. Equivalent to <b>1ST CURTAIN</b> when <b>MULTI</b> is selected for flash control mode.         </li> </ul>
<p>9 Zoom</p>	<p>The angle of illumination (flash coverage) for units that support flash zoom. Some units allow the adjustment to be made from the camera. If <b>AUTO</b> is selected, zoom will automatically be adjusted to match coverage to lens focal length.</p>

Setting	Description
⑩ Lighting	<p>If the unit supports this feature, choose from:</p> <ul style="list-style-type: none"> <li>•  (<b>FLASH POWER PRIORITY</b>): Gain range by slightly reducing coverage.</li> <li>•  (<b>STANDARD</b>): Match coverage to picture angle.</li> <li>•  (<b>EVEN COVERAGE PRIORITY</b>): Slightly increase coverage for more even lighting.</li> </ul>
⑪ Master	<p>Assign the master flash to group A (<b>Gr A</b>), B (<b>Gr B</b>), or C (<b>Gr C</b>). If <b>OFF</b> is selected, output from the master flash will be held to a level that does not affect the final picture. Available only if the unit is mounted on the camera hot shoe as a master flash for Fujifilm optical wireless remote flash control in <b>TTL</b>, <b>TTL%</b>, or <b>M</b> mode.</p>
⑪ Number of flashes	<p>Choose the number of times the flash fires each time the shutter is released in <b>MULTI</b> mode.</p>
⑫ Channel	<p>Choose the channel used by the master flash for communication with the remote flash units. Separate channels can be used for different flash systems or to prevent interference when multiple systems are operating in close proximity.</p>
⑫ Frequency	<p>Choose the frequency at which the flash fires in <b>MULTI</b> mode.</p>





# 11 Connections

## Wireless Connections (Bluetooth®, Wireless LAN/Wi-Fi)

Access wireless networks and connect to computers, smartphones, or tablets. For more information, visit:

<http://fujifilm-dsc.com/wifi/>

### Smartphones and Tablets: FUJIFILM Camera Remote

Connect to the camera via Bluetooth or wireless LAN.

 To establish a wireless connection to the camera, you will need to install the latest version of the FUJIFILM Camera Remote app on your smartphone or tablet.

#### FUJIFILM Camera Remote

Once a connection has been established, you can use FUJIFILM Camera Remote to:

- Control the camera and take pictures remotely
- Receive pictures uploaded from the camera
- Browse the pictures on the camera and download selected pictures
- Upload location data to the camera
- Release the camera shutter
- Update camera firmware

For downloads and other information, visit:

[http://app.fujifilm-dsc.com/en/camera\\_remote/](http://app.fujifilm-dsc.com/en/camera_remote/)

## SmartPhones and Tablets: Bluetooth® Pairing

Use **CONNECTION SETTING** > **Bluetooth SETTINGS** > **PAIRING REGISTRATION** to pair the camera with smartphones or tablets. Pairing offers a simple method for downloading photos from the camera.



-  Photos are downloaded via a wireless connection.
- Once pairing is complete, you will be able to synchronize the camera clock and location data with the smartphone or tablet (☎ 231).
- You can choose a connection from up to 7 paired smartphones or tablets.

## Smartphones and Tablets: Wireless LAN

Use the **WIRELESS COMMUNICATION** options in **SHOOTING SETTING** or the playback menu to connect to a smartphone or tablet via a Wireless LAN.



## Tethered Shooting: Capture One Pro Fujifilm/ Adobe® Photoshop® Lightroom® Classic CC + FUJIFILM Tether Shooting Plug-in/FUJIFILM X Acquire

- Before proceeding, select **WIRELESS TETHER SHOOTING FIXED** for **CONNECTION SETTING > PC CONNECTION MODE** in the camera menus.
- Tethered shooting can be performed using software such as Adobe® Photoshop® Lightroom® Classic CC and FUJIFILM X Acquire. If you use Adobe® Photoshop® Lightroom® Classic CC, download FUJIFILM Tether Shooting Plug-in from the Adobe Exchange website. FUJIFILM Tether Shooting Plug-in is available free of charge.

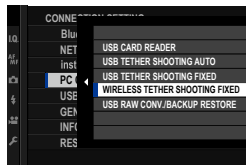

- For more information, visit the following website:  
<http://app.fujifilm-dsc.com/en/#tether>
- For more information on FUJIFILM X Acquire and FUJIFILM Tether Shooting Plug-in, see "Software for Use with Your Camera" (📖 289).

## Connecting via USB

The camera can be connected to computers and smartphones via USB.

### Connecting to Computers

Before downloading pictures or taking pictures remotely, connect the camera to a computer and check that it functions normally.

- 1 Turn the computer on.
- 2 Adjust settings according to whether you will be using the camera for tethered shooting (📖 276), copying pictures to a computer (📖 277), save RAW pictures in other formats (📖 278), or Saving and Loading Camera Settings (📖 278).
- 3 Turn the camera off.
- 4 Connect a USB cable.

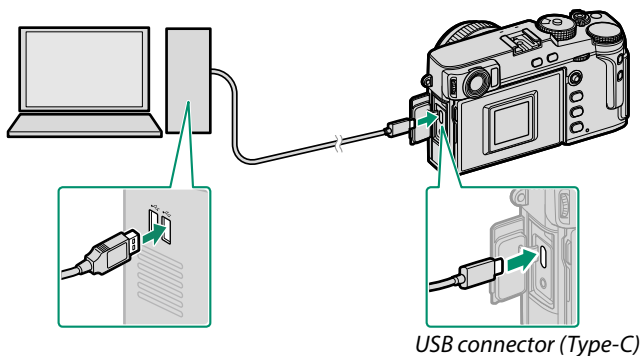

! The USB cable must be no more than 1.5 m (4.9 ft.) long and be suitable for data transfer.

5 Turn the camera on.

6 Copy pictures to your computer.

- **Tethered shooting:** During tethered shooting, you can copy pictures using tethered shooting software such as the Capture One Pro Fujifilm/Adobe® Photoshop® Lightroom® Classic CC + FUJIFILM Tether Shooting Plug-in/FUJIFILM X Acquire.
- **Image transfer:** Use applications provided with your operating system.
- **RAW conversion:** Process RAW images using FUJIFILM X RAW STUDIO. The power of the camera's image processing engine is used for rapid processing.
- **Saving and loading camera settings:** Use FUJIFILM X Acquire to save or load camera settings. Save your preferred settings to a file in a single operation and copy them to multiple cameras.

- ❗ • Turn the camera off before disconnecting the USB cable.
- When connecting USB cables, be sure the connectors are fully inserted in the correct orientation. Connect the camera directly to the computer; do not use a USB hub or keyboard.
- Loss of power during transfer could result in loss of data or damage to the memory card. Insert a fresh or fully-charged battery before connecting the camera.
- If a memory card containing a large number of images is inserted, there may be a delay before the software starts and you may be unable to import or save images. Use a memory card reader to transfer pictures.
- Make sure that the indicator lamp is off or lit green before turning the camera off.
- Do not disconnect the USB cable while transfer is in progress. Failure to observe this precaution could result in loss of data or damage to the memory card.
- Disconnect the camera before inserting or removing memory cards.
- In some cases, it may not be possible to access pictures saved to a network server using the software in the same way as on a stand-alone computer.
- Do not immediately remove the camera from the system or disconnect the USB cable once the message stating that copying is in progress clears from the computer display. If the number of images copied is very large, data transfer may continue after the message has ceased to be displayed.
- The user bears all applicable fees charged by the phone company or Internet service provider when using services that require an Internet connection.

## Tethered Shooting: Capture One Pro Fujifilm/ Adobe® Photoshop® Lightroom® Classic CC + FUJIFILM Tether Shooting Plug-in/FUJIFILM X Acquire

- Before proceeding, select **USB TETHER SHOOTING AUTO** for **CONNECTION SETTING > PC CONNECTION MODE** in the camera menus.
- Capture One Pro Fujifilm, Adobe® Photoshop® Lightroom® Classic CC + FUJIFILM Tether Shooting Plug-in, and FUJIFILM X Acquire can be used for tethered shooting.

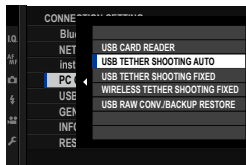

- Choose **USB TETHER SHOOTING FIXED** if the camera will be used solely for tethered shooting. Note that if the USB cable is disconnected, the camera will continue to function in tethered mode and pictures will not be saved to the camera memory card.
- For more information, visit the following website:  
<http://app.fujifilm-dsc.com/en/#tether>
- For more information on Capture One Pro Fujifilm, Adobe® Photoshop® Lightroom® Classic CC + FUJIFILM Tether Shooting Plug-in, and FUJIFILM X Acquire, see “Software for Use with Your Camera” (📖 289).



## Copying Pictures to a Computer

- Before copying pictures to a computer, select **USB CARD READER** for **CONNECTION SETTING > PC CONNECTION MODE**.
- The software that can be used to copy pictures varies with your computer operating system.

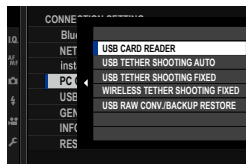

### Mac OS X/macOS

Pictures can be copied to your computer using Image Capture (supplied with your computer) or other software.

 Use a card reader to copy files over 4 GB in size.

### Windows

Pictures can be copied to your computer using applications supplied with the operating system.

## Converting RAW Images: FUJIFILM X RAW STUDIO

- Before proceeding, select **USB RAW CONV./BACKUP RESTORE** for **CONNECTION SETTING > PC CONNECTION MODE** in the camera menus.
- FUJIFILM X RAW STUDIO can be used to convert RAW images to JPEG or TIFF images.

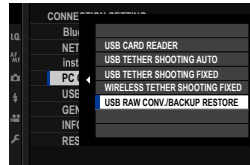

 For more information on FUJIFILM X RAW STUDIO, see “Software for Use with Your Camera” (p. 289).

## Backing up and Restoring Camera Settings (FUJIFILM X Acquire)

- Before proceeding, select **USB RAW CONV./BACKUP RESTORE** for **CONNECTION SETTING > PC CONNECTION MODE** in the camera menus.
- FUJIFILM X Acquire can be used to backup and restore camera settings.

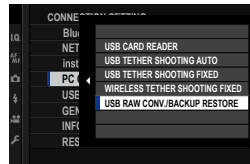

 For more information on FUJIFILM X Acquire, see “Software for Use with Your Camera” (p. 289).

## Connecting to Smartphones

To copy pictures to a smartphone, select **OFF** for **CONNECTION SETTING > USB POWER SUPPLY SETTING** and connect the camera to the phone using a USB cable.

### For Customers Using Android Devices

How you will connect the camera depends on the type of USB connector with which your smartphone is equipped.

#### Type-C

Ready a cable equipped with connectors matching the USB (Type-C) connector on the camera.

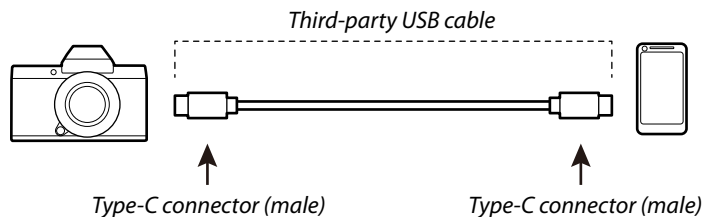

#### Micro-B

Use a USB on-the-go (OTG) cable.

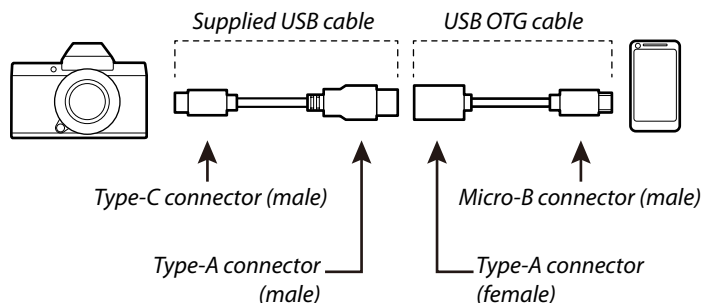

- ❗ • The smartphone must support USB OTG.
- The desired results cannot be achieved with a USB Type-C-to-Micro-B cable. Use an OTG cable.

---

**1** Set the camera's  **CONNECTION SETTING > USB POWER SUPPLY SETTING** to **OFF**.

**2** Connect the camera and smartphone using a USB cable.

 If the smartphone asks for permission for an application other than the "Camera Importer" to access the camera, tap "Cancel" and move on to the next step.

**3** On your smartphone, tap the notification "Connected to USB PTP".

**4** From the recommended applications, select "Camera Importer".

The app will automatically start and allow you to import photos and movies to your smartphone.

 If the message "There is no MTP device connected" appears on the app, please try again from step 2.

## For Customers Using iOS

An Apple Lightning to USB Camera Adapter is required.

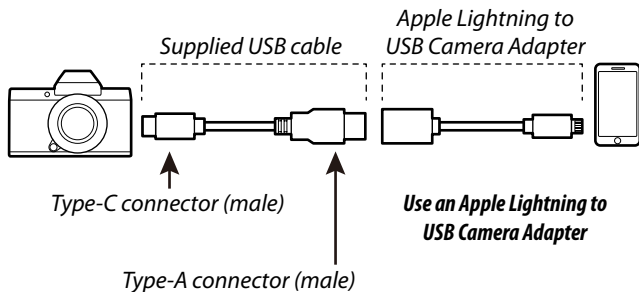

- 1 Set the camera's **CONNECTION SETTING > USB POWER SUPPLY SETTING** to **OFF**.
- 2 Connect the camera and smartphone using a USB cable. The "Photos" app will automatically start and allow you to import photos and movies to your smartphone.

**!** The desired results cannot be achieved with a USB Type-C-to-Lightning cable. Use a camera adapter.

## instax SHARE Printers

Print pictures from your digital camera to instax SHARE printers.

### Establishing a Connection

Select **CONNECTION SETTING** > **instax PRINTER CONNECTION SETTING** and enter the instax SHARE printer name (SSID) and password.

#### The Printer Name (SSID) and Password

The printer name (SSID) can be found on the bottom of the printer; the default password is "1111". If you have already chosen a different password to print from a smartphone, enter that password instead.

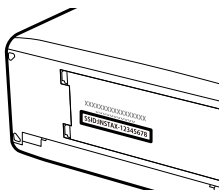

## Printing Pictures

- 1 Turn the printer on.
- 2 Select **PLAY BACK MENU > instax PRINTER PRINT**. The camera will connect to the printer.



- 3 Use the focus stick (focus lever) to display the picture you want to print, then press **MENU/OK**.



- Pictures taken with other cameras cannot be printed.
- The area printed is smaller than the area visible in the LCD monitor.
- The displays may vary depending on the printer connected.

- 4 The picture will be sent to the printer and printing will start.





# 12

## Technical Notes

## Accessories from Fujifilm

The following optional accessories are available from Fujifilm. For the latest information on the accessories available in your region, check with your local Fujifilm representative or visit [http://www.fujifilm.com/products/digital\\_cameras/index.html](http://www.fujifilm.com/products/digital_cameras/index.html).

### Rechargeable Li-ion batteries

**NP-W126S:** Additional high-capacity NP-W126S rechargeable batteries can be purchased as required.

### Battery chargers

**BC-W126S:** Replacement battery chargers can be purchased as required. At +20°C/+68°F, the BC-W126S charges an NP-W126S in about 150 minutes.

### DC couplers

**CP-W126:** For extended shooting or playback or when using the camera with a computer, use the CP-W126 to connect the camera to the AC-9V power adapter.

 A frame advance rate of 11 fps is not supported during burst shooting with the CP-W126.

### AC power adapters

**AC-9V** (requires CP-W126 DC coupler): Use this 100–240V, 50/60 Hz AC power adapter for extended shooting and playback or when copying pictures to a computer.

### Remote releases

**RR-100:** Use to reduce camera shake or keep the shutter open during a time exposure (ø2.5 mm).

### Stereo microphones

**MIC-ST1:** An external microphone for movie recording.

### FUJINON lenses

**XF-/XC-series lenses:** Interchangeable lenses for use exclusively with the FUJIFILM X-mount.

**FUJINON MKX-series lenses:** Cinema lenses for the FUJIFILM X-mount.

**Macro extension tubes**

**MCEX-11/16:** Attach between the camera and the lens to shoot at high reproduction ratios.

**Teleconverters**

**XF1.4X TC WR:** Increases the focal length of the compatible lenses by about 1.4x.

**XF2X TC WR:** Increases the focal length of the compatible lenses by about 2.0x.

**Mount adapters**

**FUJIFILM M MOUNT ADAPTER:** Allows the camera to be used with a wide selection of M-mount lenses.

**Body caps**

**BCP-001:** Cover the camera lens mount when no lens is attached.

**Shoe-mounted flash units**

**EF-X500:** In addition to manual and TTL flash control, this clip-on flash unit has a Guide Number of 50/164 (ISO 100, m/ft.) and supports FP (high-speed sync), allowing it to be used at shutter speeds that exceed the flash sync speed. Featuring support for the optional EF-BP1 battery pack and Fujifilm optical wireless flash control, it can be used as a master or remote flash unit for remote wireless flash photography.

**EF-BP1:** A battery pack for shoe-mounted flash units. Takes up to 8 AA batteries.

**EF-42:** This clip-on flash unit has a Guide Number of 42/137 (ISO 100, m/ft.) and supports manual and TTL flash control.

**EF-X20:** This clip-on flash unit has a Guide Number of 20/65 (ISO 100, m/ft.) and supports manual and TTL flash control.

**EF-20:** This clip-on flash unit has a Guide Number of 20/65 (ISO 100, m/ft.) and supports TTL flash control (manual flash control is not supported).

**Hand grips**

**MHG-XPR03:** Features an improved grip. Batteries and memory cards can be removed with the grip in place.

**Leather cases**

**BLC-XPRO3:** This case combines practicality with the luxury of leather and comes with a shoulder strap made of the same material, as well as a cloth that can be used to wrap the camera before putting it in the case and on other occasions. Pictures can be taken and batteries inserted or removed with the camera still in its case.

**Grip belts**

**GB-001:** Improves grip. Combine with a hand grip for more secure handling.

**instax SHARE printers**

**SP-1/SP-2/SP-3:** Connect via wireless LAN to print pictures on instax film.

## Software for Use with Your Camera

The camera can be used with the following software.

### FUJIFILM Camera Remote

Establish a wireless connection between your camera and a smartphone or tablet (☰ 270).

[http://app.fujifilm-dsc.com/en/camera\\_remote/](http://app.fujifilm-dsc.com/en/camera_remote/)

### Capture One Express Fujifilm

Capture One Express Fujifilm is image edit software from Phase One A/S. View RAW pictures on your computer and convert them into other formats. Capture One Express Fujifilm is available free of charge from Phase One.

<https://www.phaseone.com/fujifilm/>

### RAW FILE CONVERTER EX

RAW FILE CONVERTER EX is RAW conversion software from Ichikawa Soft Laboratory Co., Ltd. View RAW pictures on your computer and convert them into other formats. RAW FILE CONVERTER EX is available free of charge from the Fujifilm website.

<http://fujifilm-dsc.com/rfc/>

### Capture One Pro Fujifilm

Capture One Pro Fujifilm is workflow software from Phase One A/S. Capture One Pro Fujifilm supports tethered shooting and the conversion of RAW pictures into other formats.

<https://www.phaseone.com/fujifilm/>

## Adobe® Photoshop® Lightroom® Classic CC + FUJIFILM Tether Shooting Plug-in

Plug-ins for Adobe® Photoshop® Lightroom® Classic CC.

- *FUJIFILM Tether Shooting Plug-in PRO*  
<http://fujifilm-x.com/x-stories/fujifilm-tether-plug-in-pro-features/>
- *FUJIFILM Tether Shooting Plug-in*  
[http://www.fujifilm.com/products/digital\\_cameras/accessories/others/#soft](http://www.fujifilm.com/products/digital_cameras/accessories/others/#soft)

## FUJIFILM X Acquire

This application for Windows and macOS lets you connect to the camera via USB or Wi-Fi and automatically download photos to a specified folder as they are taken, or backup and restore the camera via USB.

<http://fujifilm-x.com/x-stories/fujifilm-x-acquire-features-users-guide/>

 Auto download (tethered shooting) is not supported with some cameras.

## FUJIFILM X RAW STUDIO

When the camera is connected to a computer via USB, FUJIFILM X RAW STUDIO can use the camera's unique image processing engine to rapidly convert RAW files to create high-quality images in other formats.

<http://fujifilm-x.com/x-stories/fujifilm-x-raw-studio-features-users-guide/>

# For Your Safety

## IMPORTANT SAFETY INSTRUCTIONS

- **Read Instructions:** All the safety and operating instructions should be read before the appliance is operated.
- **Retain Instructions:** The safety and operating instructions should be retained for future reference.
- **Heed Warnings:** All warnings on the appliance and in the operating instructions should be adhered to.
- **Follow Instructions:** All operating and use instructions should be followed.

### Installation

**Power Sources:** This video product should be operated only from the type of power source indicated on the marking label. If you are not sure of the type of power supply to your home, consult your appliance dealer or local power company. For video products intended to operate from battery power, or other sources, refer to the operating instructions.

**Grounding or Polarization:** This video product is equipped with a polarized alternating-current line plug (a plug having one blade wider than the other). This plug will fit into the power outlet only one way. This is a safety feature. If you are unable to insert the plug fully into the outlet, try reversing the plug. If the plug should still fail to fit, contact your electrician to replace your obsolete outlet. Do not defeat the safety purpose of the polarized plug.

**Alternate Warnings:** This video product is equipped with a three-wire grounding-type plug, a plug having a third (grounding) pin. This plug will only fit into a grounding-type power outlet. This is a safety feature. If you are unable to insert the plug into the outlet, contact your electrician to replace your obsolete outlet. Do not defeat the safety purpose of the grounding type plug.

**Overloading:** Do not overload wall outlets and extension cords as this can result in a risk of fire or electric shock.

**Ventilation:** Slots and openings in the cabinet are provided for ventilation, to ensure reliable operation of the video product and to protect it from overheating, and these openings must not be blocked or covered. The openings should never be blocked by placing the video product on a bed, sofa, rug, or other similar surface.

This video product should not be placed in a built-in installation such as a bookcase or rack unless proper ventilation is provided or the manufacturer's instructions have been adhered to. This video product should never be placed near or over a radiator or heat register.

**Attachments:** Do not use attachments not recommended by the video product manufacturer as they may cause hazards.

**Water and Moisture:** Do not use this video product near water—for example, near a bath tub, wash bowl, kitchen sink, or laundry tub, in a wet basement, or near a swimming pool, and the like.

**Power-Cord Protection:** Power-supply cords should be routed so that they are not likely to be walked on or pinched by items placed upon or against them, paying particular attention to cords at plugs, convenience receptacles, and the point where they exit from the appliance.

**Accessories:** Do not place this video product on an unstable cart, stand, tripod, bracket, or table. The video product may fall, causing serious injury to a child or adult, and serious damage to the appliance. Use only with a cart, stand, tripod, bracket, or table recommended by the manufacturer, or sold with the video product. Any mounting of the appliance should follow the manufacturer's instructions, and should use a mounting accessory recommended by the manufacturer.

An appliance and cart combination should be moved with care. Quick stops, excessive force, and uneven surfaces may cause the appliance and cart combination to overturn.



### Antennas

**Outdoor Antenna Grounding:** If an outside antenna or cable system is connected to the video product, be sure the antenna or cable system is grounded so as to provide some protection against voltage surges and built-up static charges. Section 810 of the National Electrical Code, ANSI/NFPA No. 70, provides information with respect to proper grounding of the mast and supporting structure, grounding of the lead-in wire to an antenna discharge unit, size of grounding conductors, location of antenna discharge unit, connection to grounding electrodes, and requirements for the grounding electrode.

#### EXAMPLE OF ANTENNA GROUNDING AS PER NATIONAL ELECTRICAL CODE

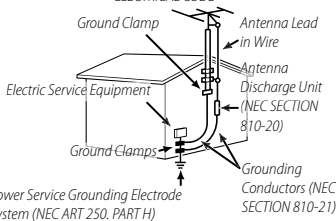

**Power Lines:** An outside antenna system should not be located in the vicinity of overhead power lines or other electric light or power circuits, or where it can fall into such power lines or circuits. When installing an outside antenna system, extreme care should be taken to keep from touching such power lines or circuits as contact with them might be fatal.

#### Use

**Cleaning:** Unplug this video product from the wall outlet before cleaning. Do not use liquid cleaners or aerosol cleaners. Use a damp cloth for cleaning.

**Object and Liquid Entry:** Never push objects of any kind into this video product through openings as they may touch dangerous voltage points or short out parts that could result in a fire or electric shock. Never spill liquid of any kind on the video product.

**Lightning:** For added protection for this video product receiver during a lightning storm, or when it is left unattended and unused for long periods of time, unplug it from the wall outlet and disconnect the antenna or cable system. This will prevent damage to the video product due to lightning and power-line surges.

#### Service

**Servicing:** Do not attempt to service this video product yourself as opening or removing covers may expose you to dangerous voltage or other hazards. Refer all servicing to qualified service personnel.

**Damage Requiring Service:** Unplug this video product from the wall outlet and refer servicing to qualified service personnel under the following conditions:

- When the power-supply cord or plug is damaged
- If liquid has been spilled, or objects have fallen into the video product.
- If the video product has been exposed to rain or water.
- If the video product has been dropped or the cabinet has been damaged.

If the video product does not operate normally follow the operating instructions. Adjust only those controls that are covered by the operating instructions as an improper adjustment of other controls may result in damage and will often require extensive work by a qualified technician to restore the video product to its normal operation.

When the video product exhibits a distinct change in performance — this indicates a need for service.

**Replacement Parts:** When replacement parts are required, be sure the service technician has used replacement parts specified by the manufacturer or have the same characteristics as the original part. Unauthorized substitutions may result in fire, electric shock or other hazards.

**Safety Check:** Upon completion of any service or repairs to this video product, ask the service technician to perform safety checks to determine that the video product is in proper operating condition.



## Be sure to read these notes before use

### Safety Notes



- Make sure that you use your camera correctly. Read these safety notes and your *Owner's Manual* carefully before use.
- After reading these safety notes, store them in a safe place.

### About the Icons



The icons shown below are used in this document to indicate the severity of the injury or damage that can result if the information indicated by the icon is ignored and the product is used incorrectly as a result.

	<b>WARNING</b>	This icon indicates that death or serious injury can result if the information is ignored.
	<b>CAUTION</b>	This icon indicates that personal injury or material damage can result if the information is ignored.

The icons shown below are used to indicate the nature of the instructions which are to be observed.

	Triangular icons tell you that this information requires attention ("Important").
	Circular icons with a diagonal bar tell you that the action indicated is prohibited ("Prohibited").
	Filled circles with an exclamation mark indicate an action that must be performed ("Required").

The symbols on the product (including the accessories) represent the following:

	AC
	DC
	Class II equipment (The construction of the product is double-insulated.)

### WARNING















Unplug from power socket













**If a problem arises, turn the camera off, remove the battery, disconnect the USB cable, and unplug the AC power adapter.** Continued use of the camera when it is emitting smoke, is emitting any unusual odor, or is in any other abnormal state can cause a fire or electric shock. Contact your Fujifilm dealer.



**Do not allow water or foreign objects to enter the camera or connecting cables.** Do not use the camera or connecting cables following ingress of fresh or salt water, milk, beverages, detergents, or other liquids. Should liquid find its way into the camera or connecting cables, turn the camera off, remove the battery, disconnect the USB cable, and disconnect and unplug the AC adapter. Continued use of the camera can cause a fire or electric shock. Contact your Fujifilm dealer.





 <b>WARNING</b>	
	<b>Do not use the camera in the bathroom or shower.</b> This can cause a fire or electric shock.
	<b>Never attempt to change or take apart the camera (never open the case).</b> Failure to observe this precaution can cause fire or electric shock.
	<b>Should the case break open as the result of a fall or other accident, do not touch the exposed parts.</b> Failure to observe this precaution could result in electric shock or in injury from touching the damaged parts. Remove the battery immediately, taking care to avoid injury or electric shock, and take the product to the point of purchase for consultation.
	<b>Do not change, heat or unduly twist or pull the connection cord and do not place heavy objects on the connection cord.</b> These actions could damage the cord and cause a fire or electric shock. If the cord is damaged, contact your Fujifilm dealer. Do not use cables with bent connectors.
	<b>Do not place the camera on an unstable surface.</b> This can cause the camera to fall or tip over and cause injury.
	<b>Never attempt to take pictures while in motion.</b> Do not use the camera while walking or driving. This can result in you falling down or being involved in a traffic accident.
	<b>Do not touch any metal parts of the camera during a thunderstorm.</b> This can cause an electric shock due to induced current from the lightning discharge.
	<b>Do not use the battery except as specified.</b> Load the battery as shown by the indicator.
	<b>Do not disassemble, modify, or heat batteries. Do not drop, strike, or throw batteries or otherwise subject them to strong impacts. Do not use batteries that show signs of leaking, deformation, discoloration, or other abnormalities. Use only designated chargers to recharge rechargeable batteries and do not attempt to recharge non-rechargeable Li-ion or alkaline batteries. Do not short batteries or store them with metallic objects.</b> Failure to observe these precautions could result in the batteries overheating, igniting, rupturing, or leaking, causing fire, burns, or other injury.
	<b>Use only batteries or AC power adapters specified for use with this camera. Do not use voltages other than the power supply voltage shown.</b> The use of other power sources can cause a fire.
	<b>If the battery leaks and fluid gets in contact with your eyes, skin or clothing, flush the affected area with clean water and seek medical attention or call an emergency number right away.</b>

 <b>WARNING</b>	
	<b>Do not use the charger to charge batteries other than those specified here.</b> The supplied charger is for use only with batteries of the type supplied with the camera. Using the charger to charge conventional batteries or other types of rechargeable batteries can cause the battery to leak, overheat or burst.
	<b>Using a flash too close to a person's eyes may cause visual impairment.</b> Take particular care when photographing infants and young children.
	<b>Do not remain in prolonged contact with hot surfaces.</b> Failure to observe this precaution could result in low-temperature burns, particularly at high ambient temperatures or with users who suffer from poor circulation or reduced sensation, in which case use of a tripod or similar precautions are recommended.
	<b>Do not leave one part of the body in contact with the product for prolonged periods while the product is on.</b> Failure to observe this precaution could result in low-temperature burns, particularly during prolonged use, at high ambient temperatures, or with users who suffer from poor circulation or reduced sensation, in which case use of a tripod or similar precautions are recommended.
	<b>Do not use in the presence of flammable objects, explosive gases, or dust.</b>
	<b>When carrying the battery, install it in a digital camera or keep it in the hard case. When storing the battery, keep it in the hard case. When discarding, cover the battery terminals with insulation tape.</b> Contact with other metallic objects or batteries could cause the battery to ignite or burst.
	<b>Keep memory cards, hot shoes, and other small parts out of the reach of small children.</b> Children may swallow small parts; keep out of reach of children. Should a child swallow a small part, seek medical attention or call emergency.
	<b>Keep out of reach of small children.</b> Among the elements that could cause injury are the strap, which could become entangled about a child's neck, causing strangulation, and the flash, which could cause visual impairment.
	<b>Follow the directions of airline and hospital personnel.</b> This product generates radio-frequency emissions that could interfere with navigational or medical equipment.
 <b>CAUTION</b>	
	<b>Do not use this camera in locations affected by oil fumes, steam, humidity or dust.</b> This can cause a fire or electric shock.
	<b>Do not leave this camera in places subject to extremely high temperatures.</b> Do not leave the camera in locations such as a sealed vehicle or in direct sunlight. This can cause a fire.

**CAUTION**

 **Do not place heavy objects on the camera.** This can cause the heavy object to tip over or fall and cause injury.

 **Do not move the camera while the AC power adapter is still connected.** Do not pull on the connection cord to disconnect the AC power adapter. This can damage the power cord or cables and cause a fire or electric shock.

 **Do not cover or wrap the camera or the AC power adapter in a cloth or blanket.** This can cause heat to build up and distort the casing or cause a fire.

 **Do not use the plug if it is damaged or if it does not fit securely into the outlet.** Failure to observe this precaution could result in fire or electric shock.

 **When you are cleaning the camera or you do not plan to use the camera for an extended period, remove the battery and disconnect and unplug the AC power adapter.** Failure to do so can cause a fire or electric shock.

**CAUTION**

 **When charging ends, unplug the charger from the power socket.** Leaving the charger plugged into the power socket can cause a fire.

 **When a memory card is removed, the card could come out of the slot too quickly. Use your finger to hold it and gently release the card.** Injury could result to those struck by the ejected card.

 **Request regular internal testing and cleaning for your camera.** Build-up of dust in your camera can cause a fire or electric shock. Contact your Fujifilm dealer to request internal cleaning every two years. Please note that this service is not free of charge.

 **Danger of explosion if battery is incorrectly replaced. Replace only with the same or equivalent type.**

 **Batteries (battery pack or batteries installed) shall not be exposed to excessive heat such as sunshine, fire or the like.**

**The Battery and Power Supply**

**Note:** Check the type of battery used in your camera and read the appropriate sections.

 **WARNING:** Battery shall not be exposed to excessive heat such as sunshine, fire or the like.

The following describes the proper use of batteries and how to prolong their life. Incorrect use can shorten battery life or cause leakage, overheating, fire, or explosion.

**Li-ion Batteries**

Read this section if your camera uses a rechargeable Li-ion battery.

The battery is not charged at shipment. Charge the battery before use. Keep the battery in its case when not in use.

**Notes on the Battery**

The battery gradually loses its charge when not in use. Charge the battery one or two days before use.

Battery life can be extended by turning the camera off when not in use.

Battery capacity decreases at low temperatures; a depleted battery may not function when cold. Keep a fully charged spare battery in a warm place and exchange as necessary, or keep the battery in your pocket or other warm place and insert it in the camera only when shooting. Do not place the battery in direct contact with hand warmers or other heating devices.

**Charging the Battery**

The battery can also be charged using an optional BC-W1265 battery charger. Charging times will increase at ambient temperatures below +10°C (+50°F) or above +35°C (+95°F). Do not attempt to charge the battery at temperatures above +40°C (+104°F); at temperatures below +5°C (+41°F), the battery will not charge.

Do not attempt to recharge a fully charged battery. The battery does not however need to be fully discharged before charging.

The battery may be warm to the touch immediately after charging or use. This is normal.

**Battery Life**

At normal temperatures, the battery can be recharged about 300 times. A noticeable decrease in the length of time the battery will hold a charge indicates that it has reached the end of its service life and should be replaced.

**Storage**

Performance may be impaired if the battery is left unused for extended periods when fully charged. Run the battery flat before storing it.

If the camera will not be used for an extended period, remove the battery and store it in a dry place with an ambient temperature of from +15°C to +25°C (+59°F to +77°F). Do not store in locations exposed to extremes of temperature.

**Cautions: Handling the Battery**

- Do not transport or store with metal objects such as necklaces or hairpins.
- Do not expose to flame or heat.
- Do not disassemble or modify.
- Use with designated chargers only.
- Dispose of used batteries promptly.
- Do not drop or subject to strong physical shocks.
- Do not expose to water.
- Keep the terminals clean.
- The battery and camera body may become warm to the touch after extended use. This is normal.

**Caution: Disposal**

Dispose of used batteries in accord with local regulations. Attention should be drawn to the environmental aspects of battery disposal. Use the apparatus under moderate climate.

**AC Power Adapters**

Use only Fujifilm AC power adapters designated for use with this camera. Other adapters could damage the camera.

- The AC power adapter is for indoor use only.
- Be sure the DC plug is securely connected to the camera.
- Turn the camera off before disconnecting the adapter. Disconnect the adapter by the plug, not the cable.
- Do not use with other devices.

- Do not disassemble.
- Do not expose to high heat and humidity.
- Do not subject to strong physical shocks.
- The adapter may hum or become hot to the touch during use. This is normal.
- If the adapter causes radio interference, reorient or relocate the receiving antenna.

**Using the Camera**

- Do not aim the camera at extremely bright light sources, including artificial light sources or natural light sources such as the sun in a cloudless sky. Failure to observe this precaution could damage the camera image sensor.
- Strong sunlight focused through the viewfinder may damage the panel of electronic viewfinder (EVF). Do not aim the electronic viewfinder at the sun.

always lit or that do not light. This is not a malfunction, and images recorded with the product are unaffected.

**Trademark Information**

Digital Split Image is a trademark or registered trademark of FUJIFILM Corporation. Digital Micro Prism is a trademark or registered trademark of FUJIFILM Corporation. The typefaces included herein are solely developed by DynaComware Taiwan Inc. Apple, iPhone, iPad, Mac, OS X, macOS and Lightning are registered trademarks of Apple Inc. in the U.S.A. and other countries. Windows is a registered trademark of Microsoft Corporation in the U.S.A. and other countries. Android is a trademark or registered trademark of Google LLC. Adobe, the Adobe logo, Photoshop, and Lightroom are trademarks or registered trademarks of Adobe Systems Incorporated in the U.S.A. and other countries. Wi-Fi® and Wi-Fi Protected Setup® are registered trademarks of the Wi-Fi Alliance. The Bluetooth® word mark and logos are registered trademarks owned by the Bluetooth SIG, Inc., and any use of such marks by Fujifilm is under license. The SDHC and SDXC logos are trademarks of SD-3C, LLC. All other trade names mentioned in this manual are the trademarks or registered trademarks of their respective owners.

**Take Test Shots**

Before taking photographs on important occasions (such as at weddings or before taking the camera on a trip), take a test shot and view the results to ensure that the camera is functioning normally. FUJIFILM Corporation cannot accept liability for damages or lost profits incurred as a result of product malfunction.

**Notes on Copyright**

Unless intended solely for personal use, images recorded using your digital camera system cannot be used in ways that infringe copyright laws without the consent of the owner. Note that some restrictions apply to the photographing of stage performances, entertainments, and exhibits, even when intended purely for personal use. Users are also asked to note that the transfer of memory cards containing images or data protected under copyright laws is only permissible within the restrictions imposed by those copyright laws.

**Electrical Interference**

This camera may interfere with hospital or aviation equipment. Consult with hospital or airline staff before using the camera in a hospital or on an aircraft.

**Handling**

To ensure that images are recorded correctly, do not subject the camera to impact or physical shocks while images are being recorded.

**Color Television Systems**

NTSC (National Television System Committee) is a color television telecasting specification adopted mainly in the U.S.A., Canada, and Japan. PAL (Phase Alternation by Line) is a color television system adopted mainly in European countries and China.

**Liquid Crystal**

In the event that the display is damaged, care should be taken to avoid contact with liquid crystal. Take the urgent action indicated should any of the following situations arise:

**Exif Print (Exif Version 2.3)**

Exif Print is a newly revised digital camera file format in which information stored with photographs is used for optimal color reproduction during printing.

- **If liquid crystal comes in contact with your skin**, clean the area with a cloth and then wash thoroughly with soap and running water.
- **If liquid crystal enters your eyes**, flush the affected eye with clean water for at least 15 minutes and then seek medical assistance.
- **If liquid crystal is swallowed**, rinse your mouth thoroughly with water. Drink large quantities of water and induce vomiting, then seek medical assistance.

Although the display is manufactured using extremely high-precision technology, it may contain pixels that are

**IMPORTANT NOTICE: Read Before Using the Software**

Direct or indirect export, in whole or in part, of licensed software without the permission of the applicable governing bodies is prohibited.

**Lenses and Other Accessories**

- Use a screw 4.5 mm or shorter when attaching a tripod.
- Fujifilm will not be held liable for performance issues or damage caused by the use of third-party accessories.

## NOTICES

To prevent fire or shock hazard, do not expose the unit to rain or moisture.

Please read the "Safety Notes" and make sure you understand them before using the camera.

Perchlorate Material—special handling may apply. See:  
<http://www.dtsc.ca.gov/hazardouswaste/perchlorate>

For Customers in the U.S.A.

### Tested To Comply With FCC Standards FOR HOME OR OFFICE USE



Contains IC : 10293A-WMBNBM26A

Contains FCC ID : COF-WMBNBM26A

**FCC Statement:** This device complies with Part 15 of the FCC Rules. Operation is subject to the following two conditions: (1) This device may not cause harmful interference, and (2) this device must accept any interference received, including interference that may cause undesired operation.

**CAUTION:** This equipment has been tested and found to comply with the limits for a Class B digital device, pursuant to Part 15 of the FCC Rules. These limits are designed to provide reasonable protection against harmful interference in a residential installation. This equipment generates, uses, and can radiate radio frequency energy and, if not installed and used in accordance with the instructions, may cause harmful interference to radio communications. However, there is no guarantee that interference will not occur in a particular installation. If this equipment does cause harmful interference to radio or television reception, which can be determined by turning the equipment off and on, the user is encouraged to try to correct the interference by one or more of the following measures:

- Reorient or relocate the receiving antenna.
- Increase the separation between the equipment and receiver.
- Connect the equipment into an outlet on a circuit different from that to which the receiver is connected.
- Consult the dealer or an experienced radio/TV technician for help.

**FCC Caution:** Any changes or modifications not expressly approved by the party responsible for compliance could void the user's authority to operate this equipment.

This transmitter must not be co-located or operating in conjunction with any other antenna or transmitter.

**Radiation Exposure Statement:** This device meets the government's requirements for exposure to radio waves. This device is designed and manufactured not to exceed the emission limits for exposure to radio frequency (RF) energy set by the Federal Communications Commission of the U.S. Government.

The exposure standard for wireless device employs a unit of measurement known as the Specific Absorption Rate, or SAR. The SAR limit set by the FCC is 1.6W/kg. Tests for SAR are conducted using standard operating positions accepted by the FCC with the device transmitting at its highest certified power level in all tested frequency bands.

**Notes on the Grant:** To comply with Part 15 of the FCC Rules, this product must be used with a Fujifilm-specified ferrite-core A/V cable, USB cable, and DC supply cord.



A lithium ion battery that is recyclable powers the product you have purchased. Please call 1-800-8-BATTERY for information on how to recycle this battery.



California Code of Regulations, Title 20, Division 2, Chapter 4, Article 4, Appliance Efficiency Regulations, Sections 1601 through 1609

**For Customers in Canada****CAN ICES-3 (B)/NMB-3(B)**

**CAUTION:** This Class B digital apparatus complies with Canadian ICES-003.

**Industry Canada statement:** This device complies with Industry Canada's licence-exempt RSSs. Operation is subject to the following two conditions: (1) This device may not cause interference; and (2) This device must accept any interference, including interference that may cause undesired operation of the device.

This device and its antenna(s) must not be co-located or operating in conjunction with any other antenna or transmitter, except tested built-in radios. The County Code Selection feature is disabled for products marketed in the US/ Canada.

**Radiation Exposure Statement:** The available scientific evidence does not show that any health problems are associated with using low power wireless devices. There is no proof, however, that these low power wireless devices are absolutely safe. Low power Wireless devices emit low levels of radio frequency energy (RF) in the microwave range while being used. Whereas high levels of RF can produce health effects (by heating tissue), exposure of low-level RF that does not produce heating effects causes no known adverse health effects. Many studies of low-level RF exposures have not found any biological effects. Some studies have suggested that some biological effects might occur, but such findings have not been confirmed by additional research. X-Pro3 has been tested and found to comply with IC radiation exposure limits set forth for an uncontrolled environment and meets RSS-102 of the IC radio frequency (RF) Exposure rules.

**Disposal of Electrical and Electronic Equipment in Private Households****In the European Union, Norway, Iceland and Liechtenstein:**

This symbol on the product, or in the manual and in the warranty, and/or on its packaging indicates that this product shall not be treated as household waste. Instead it should be taken to an applicable collection point for the recycling of electrical and electronic equipment.

By ensuring this product is disposed of correctly, you will help prevent potential negative consequences to the environment and human health, which could otherwise be caused by inappropriate waste handling of this product.

This symbol on the batteries or accumulators indicates that those batteries shall not be treated as household waste.

If your equipment contains easy removable batteries or accumulators please dispose these separately according to your local requirements.

The recycling of materials will help to conserve natural resources. For more detailed information about recycling this product, please contact your local city office, your household waste disposal service or the shop where you purchased the product.

**In Countries Outside the European Union, Norway, Iceland and Liechtenstein:**

If you wish to discard this product, including the batteries or accumulators, please contact your local authorities and ask for the correct way of disposal.

**In Japan:** This symbol on the batteries indicates that they are to be disposed of separately.



## Wireless Network and Bluetooth Devices: Cautions

This product complies with the following EU Directives:

- RoHS Directive 2011/65/EU
- RE Directive 2014/53/EU

Hereby, FUJIFILM Corporation declares that the radio equipment type FF190002 is in compliance with Directive 2014/53/EU.

The full text of the EU declaration of conformity is available at the following internet address: [http://www.fujifilm.com/products/digital\\_cameras/x/fujifilm\\_x\\_pro3/pdf/index/fujifilm\\_x\\_pro3\\_cod.pdf](http://www.fujifilm.com/products/digital_cameras/x/fujifilm_x_pro3/pdf/index/fujifilm_x_pro3_cod.pdf)

This compliance is indicated by the following conformity marking placed on the product:



This marking is valid for non-Telecom products and EU harmonized Telecom products (e.g. Bluetooth®).

**IMPORTANT:** Read the following notices before using the camera's built-in wireless transmitter.

Ⓢ This product, which contains encryption function developed in the United States, is controlled by the United States Export Administration Regulations and may not be exported or re-exported to any country to which the United States embargoes goods.

- **Use only a wireless network or Bluetooth device.** Fujifilm does not accept liability for damages resulting from unauthorized use. Do not use in applications requiring a high degree of reliability, for example in medical devices or other systems that may directly or indirectly impact human life. When using the device in computer and other systems that demand a greater degree of reliability than offered by wireless network or Bluetooth devices, be sure to take all necessary precautions to ensure safety and prevent malfunction.
- **Use only in the country in which the device was purchased.** This device conforms to regulations governing wireless network and Bluetooth devices in the country in which it was purchased. Observe all location regulations when using the device. Fujifilm does not accept liability for problems arising from use in other jurisdictions.
- **Do not use the device in locations subject to magnetic fields, static electricity, or radio interference.** Do not use the transmitter in the vicinity of microwave ovens or in other locations subject to magnetic fields, static electricity, or radio interference that may prevent reception of wireless signals. Mutual interference may occur when the transmitter is used in the vicinity of other wireless devices operating in the 2.4 GHz band.
- **The wireless transmitter operates in the 2.4 GHz band using DSSS, OFDM and GFSK modulation.**

- **Security.** Wireless network and Bluetooth devices transmit data via radio and consequently their use requires greater attention to security than applies in the case of wired networks.

- Do not connect to unknown networks or networks to which you do not have access rights, even if they are displayed on your device, as such access may be considered unauthorized. Connect only to networks to which you have access rights.
- Be aware that wireless transmissions may be vulnerable to interception by third parties.

- **The following may be punishable by law:**

- Disassembly or modification of this device
- Removal of device certification labels

- **This device operates on the same frequency as commercial, educational, and medical devices and wireless transmitters.**

It also operates on the same frequency as licensed transmitters and special unlicensed low-voltage transmitters used in RFID tracking systems for assembly lines and in other similar applications.

- **To prevent interference with the above devices, observe the following precautions.**

Confirm that the RFID transmitter is not in operation before using this device. Should you observe that the device causes interference in licensed transmitters used for RFID tracking, immediately stop using the affected frequency or move the device to another location. If you notice that this device causes interference in low-voltage RFID tracing systems, contact a Fujifilm representative.

- **Do not use this device on board an aircraft.** Note that Bluetooth may remain on even when the camera is off. Bluetooth can be disabled by selecting **OFF** for **CONNECTION SETTING > Bluetooth SETTINGS > Bluetooth ON/OFF**.

- **Maximum radio-frequency power (EIRP):**

WLAN: 11.70 dBm

Bluetooth: 3.06 dBm



## Be sure to read these notes before using the lens

## Safety Notes



- Make sure that you use the lens correctly. Read these safety notes and the camera *Owner's Manual* carefully before use.
- After reading these safety notes, store them in a safe place.

## About the Icons

The icons shown below are used in this document to indicate the severity of the injury or damage that can result if the information indicated by the icon is ignored and the product is used incorrectly as a result.

	<b>WARNING</b> This icon indicates that death or serious injury can result if the information is ignored.
	<b>CAUTION</b> This icon indicates that personal injury or material damage can result if the information is ignored.

The icons shown below are used to indicate the nature of the instructions which are to be observed.

	Triangular icons tell you that this information requires attention ("Important").
	Circular icons with a diagonal bar tell you that the action indicated is prohibited ("Prohibited").
	Filled circles with an exclamation mark indicate an action that must be performed ("Required").

 **WARNING**

	<b>Do not immerse in or expose to water.</b> Failure to observe this precaution can cause a fire or electric shock.
	<b>Do not disassemble (do not open the case).</b> Failure to observe this precaution can cause fire, electric shock, or injury due to product malfunction.
	<b>Should the case break open as the result of a fall or other accident, do not touch the exposed parts.</b> Failure to observe this precaution could result in electric shock or in injury from touching the damaged parts. Remove the battery immediately, taking care to avoid injury or electric shock, and take the product to the point of purchase for consultation.
	<b>Do not place on unstable surfaces.</b> The product may fall, causing injury.
	<b>Do not view the sun through the lens or camera viewfinders.</b> Failure to observe this precaution can cause permanent visual impairment.

 **CAUTION**

	<b>Do not use or store in locations that are exposed to steam, or smoke or are very humid or extremely dusty.</b> Failure to observe this precaution can cause fire or electric shock.
	<b>Do not leave in direct sunlight or in locations subject to very high temperatures, such as in a closed vehicle on a sunny day.</b> Failure to observe this precaution can cause fire.
	<b>Keep out of the reach of small children.</b> This product could cause injury in the hands of a child.
	<b>Do not handle with wet hands.</b> Failure to observe this precaution can cause electric shock.
	<b>Keep the sun out of the frame when shooting backlit subjects.</b> Sunlight focused into the camera when the sun is in or close to the frame can cause fire or burns.
	<b>When the product is not in use, replace the lens caps and store out of direct sunlight.</b> Sunlight focused by the lens can cause fire or burns.
	<b>Do not carry the camera or lens while they are attached to a tripod.</b> The product can fall or strike other objects, causing injury.

## Product Care

---

To ensure continued enjoyment of the product, observe the following precautions.

---

**Camera body:** Use a soft, dry cloth to clean the camera body after each use. Do not use alcohol, thinner, or other volatile chemicals, which could discolor or deform the leather on the camera body. Any liquid on the camera should be removed immediately with a soft, dry cloth. Use a blower to remove dust from the monitor, taking care to avoid scratches, and then gently wipe with a soft, dry cloth. Any remaining stains can be removed by wiping gently with a piece of Fujifilm lens-cleaning paper to which a small amount of lens-cleaning fluid has been applied. To prevent dust entering the camera, replace the body cap when no lens is in place.

**Image sensor:** Multiple photographs marred by spots or blotches in identical locations may indicate the presence of dust on the image sensor. Clean the sensor using  **USER SETTING > SENSOR CLEANING.**



## Cleaning the Image Sensor

Dust that cannot be removed using **USER SETTING > SENSOR CLEANING** can be removed manually as described below.

**!** Note that there will be a charge to repair or replace the image sensor if it is damaged during cleaning.

- 1 Use a blower (not a brush) to remove dust from the sensor.

**!** Do not use a brush or blower brush. Failure to observe this precaution could damage the sensor.

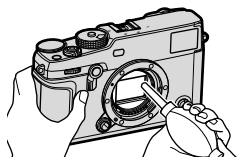

- 2 Check whether the dust has been successfully removed. Repeat Steps 1 and 2 as necessary.
- 3 Replace the body cap or lens.

## Firmware Updates

Updates to product firmware may result in changes not described in the manual. For more information, visit: [http://www.fujifilm.com/support/digital\\_cameras/software](http://www.fujifilm.com/support/digital_cameras/software)

### Checking the Firmware Version

 The camera will only display the firmware version if a memory card is inserted.

- 1 Turn the camera off and check that a memory card is inserted.
- 2 Turn the camera on while pressing the **DISP/BACK** button. The current firmware version will be displayed; check the firmware version.
- 3 Turn the camera off.

 To view the firmware version or update firmware for optional accessories such as interchangeable lenses, shoe-mounted flash units, and mount adapters, mount the accessories on the camera.

## Troubleshooting

Consult the table below should you encounter problems using your camera. If you don't find the solution here, contact your local Fujifilm distributor.

### Power and Battery

Problem	Solution
The camera does not turn on.	<ul style="list-style-type: none"><li>• <b>The battery is exhausted:</b> Charge the battery or insert a fully-charged spare battery (📖 36).</li><li>• <b>The battery is inserted incorrectly:</b> Reinsert in the correct orientation (📖 31).</li><li>• <b>The battery-chamber cover is not latched:</b> Latch the battery-chamber cover (📖 31).</li></ul>
The monitor does not turn on.	The monitor may not turn on if the camera is turned off and then on again very quickly. Keep the shutter button pressed halfway until the monitor activates.
The battery runs down quickly.	<ul style="list-style-type: none"><li>• <b>The battery is cold:</b> Warm the battery by placing it in a pocket or other warm place and reinsert it in the camera immediately before taking a picture.</li><li>• <b>There is dirt on the battery terminals:</b> Clean the terminals with a soft, dry cloth.</li><li>• <b>ON is selected for  AF/MF SETTING &gt; PRE-AF:</b> Turn PRE-AF off (📖 121).</li><li>• <b>The battery has been charged many times:</b> The battery has reached the end of its charging life. Purchase a new battery.</li></ul>
The camera turns off suddenly.	<b>The battery is exhausted:</b> Charge the battery or insert a fully-charged spare battery (📖 36).

Problem	Solution
Charging does not start (USB).	<ul style="list-style-type: none"> <li>• Insert the camera battery (📖 31).</li> <li>• Reinsert the camera battery in the correct orientation (📖 31).</li> <li>• Confirm that the camera is connected to the computer (📖 36).</li> <li>• If the computer is off or in sleep mode, turn on or wake the computer and disconnect and reconnect the USB cable (📖 36).</li> </ul>
Charging does not start (battery charger).	<ul style="list-style-type: none"> <li>• Insert the battery.</li> <li>• Reinsert the battery in the correct orientation.</li> <li>• Make sure that the charger is correctly plugged in.</li> <li>• Ensure that the plug adapter is correctly connected to the charger.</li> </ul>
Charging is slow.	Charge the battery at room temperature.
The indicator lamp blinks, but the battery does not charge.	<ul style="list-style-type: none"> <li>• <b>There is dirt on the battery terminals:</b> Clean the terminals with a soft, dry cloth (📖 31).</li> <li>• <b>The battery has been charged many times:</b> The battery has reached the end of its charging life. Purchase a new battery. If the battery still fails to charge, contact your Fujifilm dealer (📖 286).</li> </ul>
The external power source icon is not displayed.	Confirm that <b>ON</b> is selected for <b>USB POWER SUPPLY SETTING</b> (📖 236).

## Menus and Displays

Problem	Solution
Display is not in English.	Select <b>ENGLISH</b> for <b>USER SETTING</b> >  <b>言語/LANG.</b> (📖 42, 196).

## Shooting

Problem	Solution
<p>No picture is taken when the shutter button is pressed.</p>	<ul style="list-style-type: none"> <li>• <b>The memory card is full:</b> Insert a new memory card or delete pictures (📖 33, 176).</li> <li>• <b>The memory card is not formatted:</b> Format the memory card in the camera (📖 194).</li> <li>• <b>There is dirt on the memory card contacts:</b> Clean the contacts with a soft, dry cloth.</li> <li>• <b>The memory card is damaged:</b> Insert a new memory card (📖 33).</li> <li>• <b>The battery is exhausted:</b> Charge the battery or insert a fully-charged spare battery (📖 36).</li> <li>• <b>The camera has turned off automatically:</b> Turn the camera on (📖 38).</li> <li>• <b>You are using a third-party mount adapter:</b> Select <b>ON</b> for <b>SHOOT WITHOUT LENS</b> (📖 221).</li> </ul>
<p>Mottling (“noise”) appears in the monitor or viewfinder when the shutter button is pressed halfway.</p>	<p>Gain is increased to aid composition when the subject is poorly lit and aperture is stopped down, which may result in noticeable mottling when images are previewed in the displays. Images taken with the camera are unaffected.</p>
<p>The camera does not focus.</p>	<p><b>The subject is not suited to autofocus:</b> Use focus lock or manual focus (📖 84).</p>

Problem	Solution
<b>No face is detected.</b>	<ul style="list-style-type: none"> <li>• <b>The subject's face is obscured by sunglasses, a hat, long hair, or other objects:</b> Remove the obstructions (📖 122).</li> <li>• <b>The subject's face occupies only a small area of the frame:</b> Change the composition so that the subject's face occupies a larger area of the frame (📖 122).</li> <li>• <b>The subject's face is turned away from the camera:</b> Ask the subject to face the camera (📖 122).</li> <li>• <b>The camera is tilted:</b> Keep the camera level.</li> <li>• <b>The subject's face is poorly lit:</b> Shoot in bright light.</li> </ul>
<b>The flash does not fire.</b>	<ul style="list-style-type: none"> <li>• <b>The flash is disabled:</b> Adjust settings (📖 149).</li> <li>• <b>The battery is exhausted:</b> Charge the battery or insert a fully-charged spare battery (📖 36).</li> <li>• <b>The camera is in bracketing or continuous mode:</b> Select single frame mode (📖 8).</li> </ul>
<b>The flash does not fully light the subject.</b>	<ul style="list-style-type: none"> <li>• <b>The subject is not in range of the flash:</b> Position the subject in range of the flash.</li> <li>• <b>The flash window is obstructed:</b> Hold the camera correctly.</li> <li>• <b>Shutter speed is faster than the sync speed:</b> Choose a slower shutter speed (📖 60, 65, 320).</li> </ul>

Problem	Solution
Pictures are blurred.	<ul style="list-style-type: none"> <li>• <b>The lens is dirty:</b> Clean the lens.</li> <li>• <b>The lens is blocked:</b> Keep objects away from the lens (📖 45).</li> <li>• <b>!AF is displayed during shooting and the focus frame is displayed in red:</b> Check focus before shooting (📖 45).</li> </ul>
Pictures are mottled.	<ul style="list-style-type: none"> <li>• <b>Shutter speed is slow and the ambient temperature is high:</b> This is normal and does not indicate a malfunction.* Use pixel mapping (📖 111). * X-rays, cosmic rays, and other forms of radiation interacting with the image sensor may cause bright spots of various colors such as white, red, and blue. Pixel mapping helps reduce the occurrence of such bright spots.</li> <li>• <b>The camera has been used continuously at high temperatures:</b> Turn the camera off and wait for it to cool down (📖 38, 315).</li> <li>• <b>A temperature warning is displayed:</b> Turn the camera off and wait for it to cool down (📖 38, 315).</li> </ul>

## Playback

Problem	Solution
Pictures are grainy.	The pictures were taken with a different make or model of camera.
Playback zoom is unavailable.	The pictures were created using <b>RESIZE</b> or with a different make or model of camera.
No sound in movie playback.	<ul style="list-style-type: none"><li>• <b>Playback volume is too low:</b> Adjust playback volume (📖 200).</li><li>• <b>The microphone was obstructed:</b> Hold the camera correctly during recording.</li><li>• <b>The speaker is obstructed:</b> Hold the camera correctly during playback.</li></ul>
Selected pictures are not deleted.	Some of the pictures selected for deletion are protected.
Pictures remain after ERASE > ALL FRAMES is selected.	Remove protection using the device with which it was originally applied (📖 180).
File numbering is unexpectedly reset.	The battery-chamber cover was opened while the camera was on. Turn the camera off before opening the battery-chamber cover (📖 227).



## Connections

Problem	Solution
The computer does not recognize the camera.	Be sure the camera and computer are correctly connected (📖 273).
FUJIFILM X RAW STUDIO or FUJIFILM X Acquire fails to correctly detect the camera.	Check the option selected for <b>PC CONNECTION MODE</b> on the camera. Select <b>USB RAW CONV./BACKUP RESTORE</b> before connecting the USB cable (📖 278).
Cannot connect to iPhones or iPads.	<b>ON</b> is selected for <b>USB POWER SUPPLY SETTING</b> . Select <b>OFF</b> when the camera is connected via a Lightning connection to a device that do not supply power (📖 236).
Cannot connect to smartphone.	<b>Confirm that the camera is correctly connected:</b> The procedure for connecting the camera varies with the type of connector with which the smartphone is equipped (📖 279).

## Wireless Transfer

For additional information on troubleshooting wireless connections, visit:

<http://digital-cameras.support.fujifilm.com/app?pid=x>



Problem	Solution
Cannot connect to smartphone. The camera is slow to connect or upload pictures to the smartphone. Upload fails or is interrupted.	<ul style="list-style-type: none"><li>• <b>The smartphone is too far away:</b> Move the devices closer (📖 270).</li><li>• <b>Nearby devices are causing radio interference:</b> Move the camera and smartphone away from microwave ovens or cordless phones (📖 270).</li></ul>
Cannot upload images.	<ul style="list-style-type: none"><li>• <b>The smartphone is connected to another device:</b> The smartphone and camera can connect to only one device at a time. End the connection and try again (📖 270).</li><li>• <b>There are several smartphones in the vicinity:</b> Try connecting again. The presence of multiple smartphones can make connection difficult (📖 270).</li><li>• <b>The image was created on another device:</b> The camera may not be able to upload images created on other devices.</li><li>• <b>The image is a movie:</b> Although you can select movies for upload when viewing the contents of camera memory on your smartphone, upload will take some time. For information on viewing the pictures on the camera, visit: <a href="http://app.fujifilm-dsc.com/en/camera_remote/">http://app.fujifilm-dsc.com/en/camera_remote/</a></li></ul>
Smartphone will not display pictures.	Select <b>ON</b> for <b>GENERAL SETTINGS &gt; RESIZE IMAGE FOR SMARTPHONE</b>  . Selecting <b>OFF</b> increases upload times for larger images; in addition, some phones may not display images over a certain size (📖 237).

## Miscellaneous

Problem	Solution
The camera is unresponsive.	<ul style="list-style-type: none"> <li>• <b>Temporary camera malfunction:</b> Remove and reinsert the battery (📖 31).</li> <li>• <b>The battery is exhausted:</b> Charge the battery or insert a fully-charged spare battery (📖 36).</li> <li>• <b>The camera is connected to a wireless LAN:</b> End the connection.</li> <li>• <b>The controls are locked:</b> Press and hold the <b>MENU/OK</b> button to unlock the controls (📖 13, 15).</li> </ul>
The camera does not function as expected.	Remove and reinsert the battery (📖 31). If the problem persists, contact your Fujifilm dealer.
Motion in the viewfinder or monitor appears jerky rather than smooth.	When <b>NORMAL</b> is selected for <b>PERFORMANCE</b> , the frame rate will drop if no operations are performed for a set period. The normal frame rate will be restored after you operate camera controls (📖 226).
No sound.	Adjust the volume (📖 199).
Pressing the <b>Q</b> button does not display the quick menu.	<b>TTL-LOCK is active:</b> End TTL-LOCK (📖 150).







## Warning Messages and Displays

The following warnings appear in the display.

Warning	Description
 (red)	Low battery. Charge the battery or insert a fully-charged spare battery.
 (blinks red)	Battery exhausted. Charge the battery or insert a fully-charged spare battery.
<b>!AF</b> (displayed in red with red focus frame)	The camera cannot focus. Use focus lock to focus on another subject at the same distance, then recompose the picture.
Aperture or shutter speed displayed in red	The subject is too bright or too dark and the picture will be over- or under-exposed. Use the flash for additional lighting when taking photographs of poorly-lit subject.
<b>FOCUS ERROR</b>	Camera malfunction. Turn the camera off and then on again. If the message persists, contact a Fujifilm dealer.
<b>LENS CONTROL ERROR</b>	
<b>TURN OFF THE CAMERA AND TURN ON AGAIN</b>	
<b>NO CARD</b>	The shutter can only be released when a memory card is inserted. Insert a memory card.
<b>CARD NOT INITIALIZED</b>	<ul style="list-style-type: none"><li>• <b>The memory card is not formatted or the memory card has been formatted in a computer or other device:</b> Format the memory card using  <b>USER SETTING &gt; FORMAT</b>.</li><li>• <b>The memory card contacts require cleaning:</b> Clean the contacts with a soft, dry cloth. If the message is repeated, format the card. If the message persists, replace the card.</li><li>• <b>Camera malfunction:</b> Contact a Fujifilm dealer.</li></ul>



Warning	Description
<b>LENS ERROR</b>	Turn the camera off, remove the lens, and clean the mounting surfaces, then replace the lens and turn the camera on. If the problem persists, contact a Fujifilm dealer.
<b>CARD ERROR</b>	<ul style="list-style-type: none"> <li>• <b>The memory card is not formatted for use in the camera:</b> Format the card.</li> <li>• <b>The memory card contacts require cleaning or the memory card is damaged:</b> Clean the contacts with a soft, dry cloth. If the message is repeated, format the card. If the message persists, replace the card.</li> <li>• <b>Incompatible memory card:</b> Use a compatible card.</li> <li>• <b>Camera malfunction:</b> Contact a Fujifilm dealer.</li> </ul>
<b>PROTECTED CARD</b>	The memory card is locked. Unlock the card.
<b>BUSY</b>	The memory card is incorrectly formatted. Use the camera to format the card.
<b> MEMORY FULL</b>	The memory card is full and pictures cannot be recorded. Delete pictures or insert a memory card with more free space.

Warning	Description
<b>WRITE ERROR</b>	<ul style="list-style-type: none"> <li>• <b>Memory card error or connection error:</b> Reinsert the card or turn the camera off and then on again. If the message persists, contact a Fujifilm dealer.</li> <li>• <b>Not enough memory remaining to record additional pictures:</b> Delete pictures or insert a memory card with more free space.</li> <li>• <b>The memory card is not formatted:</b> Format the memory card.</li> </ul>
<b>FRAME NO. FULL</b>	<p>The camera has run out of frame numbers (current frame number is 999-9999). Insert a formatted memory card and select <b>RENEW</b> for <b>SAVE DATA SET-UP &gt; FRAME NO.</b>. Take a picture to reset frame numbering to 100-0001, then select <b>CONTINUOUS</b> for <b>FRAME NO.</b></p>
<b>READ ERROR</b>	<ul style="list-style-type: none"> <li>• <b>The file is corrupt or was not created with the camera:</b> The file cannot be viewed.</li> <li>• <b>The memory card contacts require cleaning:</b> Clean the contacts with a soft, dry cloth. If the message is repeated, format the card. If the message persists, replace the card.</li> <li>• <b>Camera malfunction:</b> Contact a Fujifilm dealer.</li> </ul>
<b>PROTECTED FRAME</b>	<p>An attempt was made to delete or rotate a protected picture. Remove protection and try again.</p>

Warning	Description
<b>CAN NOT CROP</b>	The picture is damaged or was not created with the camera.
<b>DPOF FILE ERROR</b>	Print orders can contain no more than 999 pictures. Copy any additional pictures you wish to print to another memory card and create a second print order.
<b>CAN NOT SET DPOF</b>	The picture cannot be printed using DPOF.
 <b>CAN NOT SET DPOF</b>	Movies cannot be printed using DPOF.
<b>CAN NOT ROTATE</b>	The selected picture cannot be rotated.
 <b>CAN NOT ROTATE</b>	Movies cannot be rotated.
 <b>CANNOT EXECUTE</b>	Red-eye removal cannot be applied to movies.
 <b>CANNOT EXECUTE</b>	Red-eye removal cannot be applied to pictures created with other devices.
 (yellow)	Turn the camera off and wait for it to cool. Mottling may increase in pictures taken when this warning is displayed.
 (red)	Turn the camera off and wait for it to cool. While this warning is displayed, movie recording may not be available, mottling may increase, and performance, including frame advance rate and display quality, may drop.

## Memory Card Capacity

The following table shows the recording time or number of pictures available at different image sizes. All figures are approximate; file size varies with the scene recorded, producing wide variations in the number of files that can be stored. The number of exposures or length remaining may not diminish at an even rate.

		Capacity	8 GB		16 GB	
			FINE	NORMAL	FINE	NORMAL
Photos	 3:2		490	740	1020	1530
	RAW (UNCOMPRESSED)		130		270	
	RAW (LOSSLESS COMPRESSED)		240		500	
Movies 1,2	 2160		9 minutes		20 minutes	
	 1080		9 minutes		20 minutes	

1 Use a UHS speed class 3 card or better.

2 Assumes default bit rate.

 If the memory card has a capacity of over 32 GB, movies will be recorded in single files, regardless of size. If the card has a capacity of 32 GB or less, movies over 4 GB in size will be recorded uninterrupted across multiple files.



## Specifications

System															
<b>Model</b>	FUJIFILM X-Pro3														
<b>Product Number</b>	FF190002														
<b>Effective pixels</b>	Approx. 26.1 million														
<b>Image sensor</b>	23.5 mm × 15.6 mm (APS-C), X-Trans CMOS sensor with primary color filter														
<b>Storage media</b>	Fujifilm-recommended SD/SDHC/SDXC memory cards														
<b>Memory card slots</b>	Two SD memory card slots (UHS-II compliant)														
<b>File system</b>	Compliant with Design Rule for Camera File System (DCF2.0), Exif 2.3, and Digital Print Order Format (DPOF)														
<b>File format</b>	<ul style="list-style-type: none"> <li>• <b>Still pictures:</b> Exif 2.3 JPEG (compressed); RAW (original RAF format, uncompressed or compressed using a lossless algorithm; special purpose software required); RAW+JPEG available; TIFF (RGB)</li> <li>• <b>Movies:</b> H.264 standard with stereo sound (MOV)</li> <li>• <b>Audio (voice memos):</b> Stereo sound (WAV)</li> </ul>														
<b>Image size</b>	<table border="0"> <tr> <td><b>L 3:2</b> (6240 × 4160)</td> <td><b>L 1:1</b> (4160 × 4160)</td> </tr> <tr> <td><b>L 16:9</b> (6240 × 3512)</td> <td></td> </tr> <tr> <td><b>M 3:2</b> (4416 × 2944)</td> <td><b>M 1:1</b> (2944 × 2944)</td> </tr> <tr> <td><b>M 16:9</b> (4416 × 2488)</td> <td></td> </tr> <tr> <td><b>S 3:2</b> (3120 × 2080)</td> <td><b>S 1:1</b> (2080 × 2080)</td> </tr> <tr> <td><b>S 16:9</b> (3120 × 1760)</td> <td></td> </tr> <tr> <td><b>RAW</b> (6240 × 4160)</td> <td><b>TIFF</b> (6240 × 4160)</td> </tr> </table>	<b>L 3:2</b> (6240 × 4160)	<b>L 1:1</b> (4160 × 4160)	<b>L 16:9</b> (6240 × 3512)		<b>M 3:2</b> (4416 × 2944)	<b>M 1:1</b> (2944 × 2944)	<b>M 16:9</b> (4416 × 2488)		<b>S 3:2</b> (3120 × 2080)	<b>S 1:1</b> (2080 × 2080)	<b>S 16:9</b> (3120 × 1760)		<b>RAW</b> (6240 × 4160)	<b>TIFF</b> (6240 × 4160)
<b>L 3:2</b> (6240 × 4160)	<b>L 1:1</b> (4160 × 4160)														
<b>L 16:9</b> (6240 × 3512)															
<b>M 3:2</b> (4416 × 2944)	<b>M 1:1</b> (2944 × 2944)														
<b>M 16:9</b> (4416 × 2488)															
<b>S 3:2</b> (3120 × 2080)	<b>S 1:1</b> (2080 × 2080)														
<b>S 16:9</b> (3120 × 1760)															
<b>RAW</b> (6240 × 4160)	<b>TIFF</b> (6240 × 4160)														
<b>Lens mount</b>	FUJIFILM X mount														
<b>Sensitivity</b>	<ul style="list-style-type: none"> <li>• <b>Still pictures:</b> Standard output sensitivity equivalent to ISO 160–12800 in increments of 1/3 EV; AUTO; extended output sensitivity equivalent to ISO 80, 100, 125, 25600, or 51200</li> <li>• <b>Movies:</b> Standard output sensitivity equivalent to ISO 160–12800 in increments of 1/3 EV; AUTO; extended output sensitivity equivalent to ISO 25600</li> </ul>														
<b>Metering</b>	256-segment through-the-lens (TTL) metering; MULTI, SPOT, AVERAGE, CENTER WEIGHTED														
<b>Exposure control</b>	Programmed AE (with program shift); shutter-priority AE; aperture-priority AE; manual exposure														

## System

**Exposure compensation** • **Still pictures:** -5 EV to +5 EV in increments of  $\frac{1}{3}$  EV

- **Movies:** -2 EV to +2 EV in increments of  $\frac{1}{3}$  EV

## Shutter speed

- **MECHANICAL SHUTTER**

- **Mode P:** 4 s to  $\frac{1}{8000}$  s
- **Mode A:** 30 s to  $\frac{1}{8000}$  s
- **Modes S and M:** 15 min. to  $\frac{1}{8000}$  s
- **Bulb:** Max. 60 min.

- **ELECTRONIC SHUTTER**

- **Mode P:** 4 s to  $\frac{1}{32000}$  s
- **Mode A:** 30 s to  $\frac{1}{32000}$  s
- **Modes S and M:** 15 min. to  $\frac{1}{32000}$  s
- **Bulb:** Fixed at 1 s

- **E-FRONT CURTAIN SHUTTER, E-FRONT + MECHANICAL**

- **Mode P:** 4 s to  $\frac{1}{8000}$  s
- **Mode A:** 30 s to  $\frac{1}{8000}$  s
- **Modes S and M:** 15 min. to  $\frac{1}{8000}$  s
- **Bulb:** Max. 60 min.

- **MECHANICAL + ELECTRONIC, E-FRONT + MECHANICAL + ELECTRONIC**

- **Mode P:** 4 s to  $\frac{1}{32000}$  s
- **Mode A:** 30 s to  $\frac{1}{32000}$  s
- **Modes S and M:** 15 min. to  $\frac{1}{32000}$  s
- **Bulb:** Max. 60 min.

## System

## Continuous

CONTINUOUS MODE	Available frame advance rates (JPEG)
30fps(1.25X CROP) <sup>1</sup>	30
20fps(1.25X CROP) <sup>1</sup>	20
20fps <sup>1</sup>	20
11fps <sup>2</sup>	11
10fps(1.25X CROP) <sup>1</sup>	10
10fps <sup>1</sup>	10
8.0fps	8.0
5.7fps	5.7
5.0fps	5.0
4.0fps	4.0
3.0fps	3.0

<sup>1</sup> Available with electronic shutter only.

<sup>2</sup> 10 fps with electronic shutter.

 The frame rate and number of frames per burst varies with shooting conditions and type of memory card used.

## Focus

- **Mode:** Single or continuous AF; manual focus with focus ring
- **Autofocus system:** Intelligent hybrid AF (TTL contrast-detect/phase-detection AF) with AF-assist illuminator
- **Focus-area selection:** SINGLE POINT, ZONE, WIDE/TRACKING, ALL



## White balance

Auto, Custom 1, Custom 2, Custom 3, color temperature selection, direct sunlight, shade, daylight fluorescent, warm white fluorescent, cool white fluorescent, incandescent, underwater

## Self-timer

Off, 2 sec., 10 sec.

## Flash mode

- **MODE:** TTL MODE (FLASH AUTO, STANDARD, SLOW SYNC.), MANUAL, MULTI, OFF
- **SYNC. MODE:** 1ST CURTAIN, 2ND CURTAIN, AUTO FP (high-speed sync)
- **RED EYE REMOVAL:**  FLASH+REMOVAL,  FLASH,  REMOVAL, OFF

## System

<b>Hot shoe</b>	Accessory shoe with TTL contacts; supports sync speeds as fast as $\frac{1}{250}$ s
<b>Sync contact</b>	X contact; supports sync speeds as fast as $\frac{1}{250}$ s
<b>Optical viewfinder (OVF)</b>	Reverse Galilean viewfinder with electronic bright frame display and approx. $0.52\times$ magnification; frame coverage approx. 95%
<b>Electronic viewfinder (EVF)</b>	0.5-in., 3690k-dot OLED viewfinder; magnification $0.66\times$ with 50 mm lens (35 mm format equivalent) at infinity and diopter set to $-1.0\text{ m}^{-1}$ ; diagonal angle of view approximately $32^\circ$ (horizontal angle of view approximately $27^\circ$ ) <ul style="list-style-type: none"><li>• <b>Diopter adjustment:</b> <math>-4</math> to <math>+2\text{ m}^{-1}</math></li><li>• <b>Eyepoint:</b> Approximately 16.8 mm</li></ul>
<b>LCD monitor</b>	3.0-in./7.6 cm, 1620k-dot color touchscreen LCD monitor, tilting
<b>Sub monitor</b>	1.28-in./3.25 cm, $176 \times 176$ -dot memory LCD monitor
<b>Movies (with stereo sound)</b>	<ul style="list-style-type: none"><li>• <b>Movie size:</b> <b>4K</b> 16:9, <b>DCI</b> 17:9, <b>FHD</b> 16:9, <b>FHD</b> 17:9</li><li>• <b>Frame rate:</b> 59.94P, 50P, 29.97P, 25P, 24P, 23.98P</li><li>• <b>Bit rate:</b> 200Mbps, 100Mbps, 50Mbps</li><li>• <b>Recording/output format:</b> SD card, 4:2:0, 8-bit</li></ul>
<b>High-speed movies</b>	<ul style="list-style-type: none"><li>• <b>Movie size:</b> FULL HD 16:9</li><li>• <b>Frame advance rate:</b> 120P, 100P</li></ul>

## Input/output terminals

<b>Microphone connector</b>	$\varnothing 2.5$ mm mini-stereo jack
<b>Headphone jack socket</b>	The USB connector can be converted to a headphone jack socket using a USB Type-C to $\varnothing 3.5$ mm stereo mini-pin jack adapter cable compatible with analog audio I/O (USB Type-C Audio Adapter Accessory Mode)
<b>Remote release connector</b>	$\varnothing 2.5$ mm 3-pole mini jack
<b>Digital input/output</b>	USB connector (Type-C) USB3.1Gen1

**Power supply/other****Power supply** NP-W126S rechargeable battery (supplied with camera)**Battery life**

- **Battery type:** NP-W126S
- **Lens:** XF35mmF1.4 R
- **Flash:** Disabled
- **Shooting mode:** Mode P

**Number of shots**

PERFORMANCE	LCD	EVF	OVF
<b>BOOST</b>	Approx. 310	Approx. 260	Approx. 390
<b>NORMAL</b>	Approx. 390	Approx. 370	Approx. 440

**Total length of footage that can be recorded on a single charge**

Mode	Actual battery life of movie capture	Continuance battery life of movie capture
<b>4K</b> <sup>1</sup>	Approx. 45 minutes	Approx. 60 minutes
<b>FHD</b> <sup>2</sup>	Approx. 45 minutes	Approx. 75 minutes
<b>High-speed movies</b> <sup>3</sup>	Approx. 40 minutes	Approx. 60 minutes

1 At a frame rate of 29.97 fps.

2 At a frame rate of 59.94 fps.

3 At a frame rate of 120 fps.

CIPA standard. Measured using battery supplied with camera and SD memory card.

**Note:** Battery endurance varies with battery charge level and the figures given above are not guaranteed. Battery endurance will decline at low temperatures.**Camera size** 140.5 mm × 82.8 mm × 46.1 mm (34.8 mm excluding projections, measured at thinnest part)/5.53 in. × 3.26 in. × 1.81 in. (1.37 in.)**Camera weight** Approx. 447 g/15.8 oz., excluding battery, accessories, and memory card**Shooting weight** Approx. 497 g/17.5 oz., including battery and memory card

**Operating conditions**

- **Temperature:** -10 °C to +40 °C/+14 °F to +104 °F (0 °C to +40 °C/+32 °F to +104 °F when battery is charging)
- **Humidity:** 10% to 80% (no condensation)

**Wireless transmitter****Wireless LAN**

<b>Standards</b>	IEEE 802.11b/g/n (standard wireless protocol)
<b>Operating frequency (center frequency)</b>	2,412 MHz–2,462 MHz (11 channels)
<b>Access protocols</b>	Infrastructure

**Bluetooth®**

<b>Standards</b>	Bluetooth version 4.2 (Bluetooth Low Energy)
<b>Operating frequency (center frequency)</b>	2,402 MHz–2,480 MHz

**NP-W126S rechargeable battery**

<b>Nominal voltage</b>	7.2 V
<b>Nominal capacity</b>	1260 mAh
<b>Operating temperature</b>	0 °C to +40 °C/+32 °F to +104 °F
<b>Dimensions (W × H × D)</b>	36.4 mm × 47.1 mm × 15.7 mm/1.4 in. × 1.9 in. × 0.6 in.
<b>Weight</b>	Approx. 47 g/1.7 oz.

 Weight and dimensions vary with the country or region of sale.

 Specifications and performance are subject to change without notice. Fujifilm will not be held liable for any errors this manual may contain. The appearance of the product may differ from that described in this manual.



# FUJIFILM

---

## FUJIFILM Corporation

7-3, AKASAKA 9-CHOME, MINATO-KU, TOKYO 107-0052, JAPAN

[http://www.fujifilm.com/products/digital\\_cameras/index.html](http://www.fujifilm.com/products/digital_cameras/index.html)

