

Canon

EOS-1D X Mark II

EOS-1D X Mark II (G)



Instruction manuals (PDF files) and software can be downloaded from the Canon website (p.4).

www.canon.com/icpd

ENGLISH

**INSTRUCTION
MANUAL**

Introduction

The EOS-1D X Mark II (G) is a digital single-lens reflex camera featuring a full-frame CMOS sensor (approx. 35.9 mm x 23.9 mm) with approx. 20.2 effective megapixels, Dual DIGIC 6+, normal ISO speed range of ISO 100 - ISO 51200, viewfinder with approx. 100% field of view coverage, high-precision and high-speed 61-point AF (up to 41 cross-type AF points), maximum continuous shooting speed of approx. 14.0 fps during viewfinder shooting or approx. 16.0 fps during Live View shooting, 3.2-inch (approx. 1.62 million dots) LCD monitor, Live View shooting, 4K 59.94p/50.00p movie shooting, High Frame Rate movie shooting (Full HD at 119.9p/100.0p), Dual-Pixel CMOS AF, and GPS function.

Before Starting to Shoot, Be Sure to Read the Following

To avoid botched pictures and accidents, first read the “Safety Precautions” (p.20-22) and “Handling Precautions” (p.23-25). Also, read this manual carefully to ensure that you use the camera correctly.

Refer to This Manual while Using the Camera to Further Familiarize Yourself with the Camera

While reading this manual, take a few test shots and see how they come out. You can then better understand the camera. Be sure to store this manual safely, too, so that you can refer to it again when necessary.

Testing the Camera Before Use and Liability

After shooting, play images back and check whether they have been properly recorded. If the camera or memory card is faulty and the images cannot be recorded or downloaded to a computer, Canon cannot be held liable for any loss or inconvenience caused.

Copyrights

Copyright laws in your country may prohibit the use of your recorded images of people and certain subjects for anything but private enjoyment. Also be aware that certain public performances, exhibitions, etc., may prohibit photography even for private enjoyment.

Item Check List

Before starting, check that all the following items are included with your camera. If anything is missing, contact your dealer.



Camera

(with body cap and
battery compartment cap)



Eyecup Eg



**Battery Pack
LP-E19**

(with protective cover)



**Battery Charger
LC-E19**

(with protective covers)

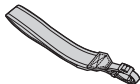

Wide Strap

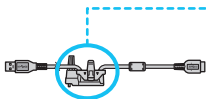

**Interface Cable
IFC-150U II**



**Cable
protector**

- * Attach the Eyecup Eg to the viewfinder eyepiece.
- * Be careful not to lose any of the above items.

Wired LAN Functions

To use wired LAN with the Ethernet RJ-45 terminal (p.28), refer to the EOS-1D X Mark II (G) "Wired LAN Instruction Manual" (p.4).

Connecting to Peripheral Devices

When connecting the camera to a computer etc., use the provided interface cable or one from Canon. When connecting an interface cable, also use the provided cable protector (p.38).

Instruction Manuals

Instruction manuals (PDF files) can be downloaded from the Canon website.

- **Instruction manual (PDF files) download site:**
 - **Camera Instruction Manual, Wired LAN Instruction Manual, and Software Instruction Manuals**
 - ▶ www.canon.com/icpd

Compatible Cards

The following cards can be used with the camera regardless of capacity: **If the card is new or was previously formatted (initialized) by another camera or computer, format the card with this camera** (p.74).

- **CF** (CompactFlash) **cards**
* Type I, UDMA Mode 7 supported.
- **CFast card**
* CFast 2.0 supported.

Cards that Can Record Movies

When shooting movies, use a large-capacity card with good enough performances (fast enough reading and writing speeds) to handle the movie recording quality. For details, see page 316.

In this manual, “CF card” refers to CompactFlash cards and “CFast card” refers to CFast memory cards. “Card” refers to all memory cards.

* **The camera does not come with a card for recording images/movies.**
Please purchase it separately.

Quick Start Guide

1

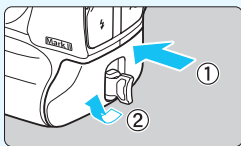

Insert the battery (p.47).

- To charge the battery, see page 42.

2

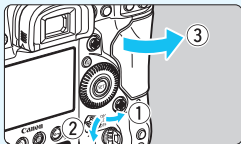

Insert the card (p.49).

- The left slot is for CF cards, and the right slot is for CFast cards.

* Shooting is possible as long as there is a CF card or CFast card in the camera.

3

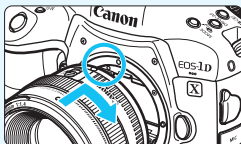

Attach the lens (p.59).

- Align the red mount index on the lens with the red mount index on the camera.

4

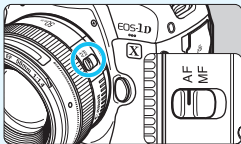

Set the lens's focus mode switch to <AF> (p.59).

5

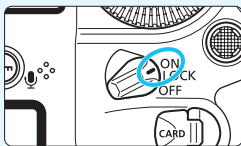

Set the power switch to <ON> (p.53).

6

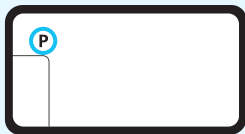
**Set the shooting mode to <P>**

(p.228).

- Press the <MODE> button.
- Look at the top LCD panel and turn the <☀> or <☉> dial to select <P>.

7

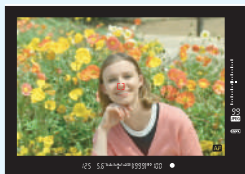
**Focus on the subject** (p.62).

- Look through the viewfinder and aim the viewfinder center over the subject.
- Press the shutter button halfway, and the camera will focus on the subject.

8

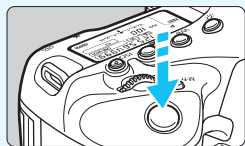
**Take the picture** (p.62).

- Press the shutter button completely to take the picture.

9





**Review the picture.**

- The image just captured will be displayed for approx. 2 sec. on the LCD monitor.
- To display the image again, press the <▶> button (p.344).

- To shoot while looking at the LCD monitor, see “Live View Shooting” (p.271).
- To view the images captured so far, see “Image Playback” (p.344).
- To delete an image, see “Erasing Images” (p.386).

Conventions Used in this Manual

Icons in this Manual

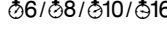
-  : Indicates the Main Dial.
-  : Indicates the Quick Control Dial.
-  : Indicates the Multi-controller.
-  : Indicates the Setting button.
-  : Indicates that each function remains active for approx. 6 sec., 8 sec., 10 sec., or 16 sec. after you let go of the button.

* In addition to the above, the icons and symbols used on the camera's buttons and displayed on the LCD monitor are also used in this manual when discussing relevant operations and functionality.

MENU : Indicates a function that can be changed by pressing the <MENU> button to change its settings.

(p.**): Reference page numbers for more information.

 : Warning to prevent shooting problems.

 : Supplemental information.

 : Tips or advice for better shooting.

 : Troubleshooting advice.

Basic Assumptions

- All operations explained in this manual assume that the power switch is already set to <ON> (p.53).
- It is assumed that all the menu settings and Custom Functions are set to their defaults.
- The illustrations in this manual show the camera attached with the EF50mm f/1.4 USM lens as an example.

Chapters



	Introduction	2
1	Getting Started	41
2	Setting the AF and Drive Modes	87
3	Image Settings	151
4	GPS Settings	211
5	Exposure Control for Photographic Expressions	227
6	Flash Photography	259
7	Shooting with the LCD Monitor (Live View Shooting)	271
8	Shooting Movies	295
9	Image Playback	343
10	Post-Processing Images	391
11	Sensor Cleaning	401
12	Transferring Images to a Computer and Print Ordering	407
13	Customizing the Camera	417
14	Reference	477
15	Software Overview	549

Contents



Introduction 2

Item Check List.....	3
Instruction Manuals	4
Compatible Cards.....	5
Quick Start Guide	6
Conventions Used in this Manual.....	8
Chapters.....	9
Index to Features	17
Safety Precautions	20
Handling Precautions	23
Nomenclature	26

1 Getting Started 41

Charging the Battery	42
Installing and Removing the Battery.....	47
Installing and Removing the Card	49
Turning on the Power	53
Setting the Date, Time, and Zone	55
Selecting the Interface Language.....	58
Attaching and Detaching a Lens	59
Basic Operation.....	61
 Quick Control for Shooting Functions	68
 Menu Operations.....	71
Before You Start.....	74
Formatting the Card.....	74
Disabling the Beeper	76
Setting the Power-off Time/Auto Power Off	76
Setting the Image Review Time.....	77

Reverting the Camera to the Default Settings	77
⌘ Displaying the Grid in the Viewfinder	81
📷 Displaying the Electronic Level	82
Setting the Viewfinder Information Display	84
🔍 Help	85
2 Setting the AF and Drive Modes	87
AF: Selecting the AF Operation	88
📷 Selecting the AF Area and AF Point	91
AF Area Selection Modes	96
AF Sensor	100
Lenses and Usable AF Points	102
Selecting AI Servo AF Characteristics	113
Customizing AF Functions	122
Fine Adjustment of AF's Point of Focus	138
When Autofocus Fails	144
MF: Manual Focus	145
📷 Selecting the Drive Mode	146
🕒 Using the Self-timer	150
3 Image Settings	151
Selecting the Card for Recording and Playback	152
Setting the Image-Recording Quality	155
ISO: Setting the ISO Speed for Still Photos	163
Selecting a Picture Style	169
Customizing a Picture Style	172
Registering a Picture Style	175
WB: Setting the White Balance	177







 Custom White Balance	180
K Setting the Color Temperature	185
 White Balance Correction	186
Auto Correction of Brightness and Contrast	189
Setting Noise Reduction	190
Highlight Tone Priority	193
Correction of Lens Aberrations	194
Reducing Flicker	198
Setting the Color Space	200
Creating and Selecting a Folder	201
Changing the File Name	203
File Numbering Methods	206
Setting Copyright Information	208

4 GPS Settings 211

GPS Features	212
GPS Precautions	214
Acquiring GPS Signals	215
Setting the Positioning Interval	220
Setting Time from GPS on the Camera	221
Logging the Route Traveled	222

5 Exposure Control for Photographic Expressions 227

P : Program AE	228
Tv : Shutter-Priority AE	231
Av : Aperture-Priority AE	233
Depth-of-Field Preview	235
M : Manual Exposure	236

 Selecting the Metering Mode	238
 Setting the Desired Exposure Compensation	241
 Auto Exposure Bracketing (AEB)	243
 Locking the Exposure for Shooting (AE Lock).....	245
bulb : Bulb Exposures	246
 Multiple Exposures.....	248
 Mirror Lockup	256
Using the Eyepiece Shutter	258
 Using a Remote Switch.....	258

6 Flash Photography 259

 Flash Photography	260
Setting the Flash Function	263

7 Shooting with the LCD Monitor (Live View Shooting) 271















 Shooting with the LCD Monitor	272
Shooting Function Settings	278
Menu Function Settings	280
Focusing with AF (AF Method)	284
MF: Focusing Manually	291

8 Shooting Movies 295



 Shooting Movies	296
Autoexposure Shooting	296
Shutter-priority AE	297
Aperture-priority AE	298
Manual Exposure Shooting	301
Shooting Function Settings	309
Setting the Movie Recording Quality	311

Setting the Sound Recording	322
Silent Control	325
Setting the Time Code.....	326
Menu Function Settings.....	330

9 Image Playback 343

 Image Playback	344
INFO.: Shooting Information Display.....	346
 Searching for Images Quickly	352
 Display Multiple Images on One Screen (Index Display).....	352
 Jumping through Images (Jump Display).....	353
 Magnifying Images.....	355
 Rotating the Image	357
 Protecting Images.....	358
Setting Ratings.....	361
 Recording and Playing back Voice Memos.....	363
 Quick Control for Playback	365
 Enjoying Movies	367
 Playing Back Movies	369
 Editing a Movie's First and Last Scenes	372
 Grabbing a Frame from 4K Movies	374
Slide Show (Auto Playback).....	376
Viewing Images on a TV Set.....	379
 Copying Images	382
 Erasing Images.....	386
Changing Image Playback Settings	389
Adjusting the LCD Monitor Brightness.....	389
Auto Rotation of Vertical Images	390



10 Post-Processing Images 391

 Processing RAW Images with the Camera	392
 Resizing JPEG Images	397
 Cropping JPEG Images	399

11 Sensor Cleaning 401

 Automatic Sensor Cleaning	402
Appending Dust Delete Data	403
Manual Sensor Cleaning	405

12 Transferring Images to a Computer and Print Ordering 407

 Transferring Images to a Computer	408
 Digital Print Order Format (DPOF)	413

13 Customizing the Camera 417

Custom Functions	418
Custom Function Settings	421
C.Fn1: Exposure	421
C.Fn2: Exposure	424
C.Fn3: Exposure	427
C.Fn4: Drive	431
C.Fn5: Display/Operation	433
C.Fn6: Operation	436
C.Fn7: Others	439
 Custom Controls	443
Custom Quick Control	459
Registering My Menu	463
Saving and Loading Camera Settings	468
C : Registering Custom Shooting Modes	472

14 Reference 477

INFO. Button Functions.....	478
Checking the Battery Information	482
Using a Household Power Outlet	483
System Map	484
Function Availability Table by Shooting Mode.....	486
Menu Settings	490
Troubleshooting Guide	502
System Status Display	520
Error Codes	523
Specifications	524

15 Software Overview 549

Software Overview	550
Installing the Software	551
Index.....	552

Index to Features

Power

- Charging the battery → p.42
- Battery level → p.54
- Battery information check → p.482
- Household power outlet → p.483
- Auto power off → p.76

Card

- Formatting → p.74
- Recording function → p.152
- Selecting card → p.154
- Release shutter without card → p.50

Lens

- Attaching → p.59
- Detaching → p.60

Basic Settings

- Language → p.58
- Date/Time/Zone → p.55
- Beeper → p.76
- Copyright information → p.208
- Clear all camera settings → p.77

Viewfinder

- Dioptic adjustment → p.61
- Eyepiece shutter → p.258
- Electronic level → p.83
- Grid → p.81
- Information display in viewfinder → p.84
- Focusing Screen → p.433

LCD monitor

- Brightness adjustment → p.389
- Electronic level → p.82
- LV touch control → p.283
- Help → p.85

AF

- AF operation → p.88
- AF area selection mode → p.91
- AF point selection → p.94
- AF point registration → p.448
- Lens group → p.102
- AI Servo AF characteristics → p.113
- EOS iTR AF → p.127
- Customizing AF functions → p.122
- AF point brightness → p.136
- AF Microadjustment → p.138
- Manual focusing → p.145

Metering

- Metering mode → p.238
- Multi-spot metering → p.240

Drive

- Drive mode → p.146
- Self-timer → p.150
- Maximum burst → p.161

Recording Images

- Recording function → p.152
- Selecting card → p.154
- Creating/Selecting a folder → p.201

- File name → p.203
- File numbering → p.206

Image Quality

- Image size → p.155
- JPEG quality (Compression rate) → p.162
- ISO speed (still photos) → p.163
- Picture Style → p.169
- White balance → p.177
- Auto Lighting Optimizer → p.189
- Noise reduction for high ISO speeds → p.190
- Noise reduction for long exposures → p.191
- Highlight tone priority → p.193
- Lens aberration correction → p.194
- Reducing flicker → p.198
- Color space → p.200

Shooting

- Shooting mode → p.32
- Multiple exposures → p.248
- Mirror lockup → p.256
- Depth-of-field preview → p.235
- Remote Switch → p.258
- Quick Control → p.68
- Multi function lock → p.66

Exposure

- Exposure compensation → p.241
- Exposure compensation with M+ISO Auto → p.237
- AEB → p.243
- AE lock → p.245
- Safety shift → p.424

GPS

- GPS → p.211
- Logging → p.222

Flash

- External Speedlite → p.260
- Flash exposure compensation → p.260
- FE lock → p.260
- Flash function settings → p.263
- Flash Custom Function settings → p.268

Live View Shooting

- Live View shooting → p.271
- AF method → p.284
- LV touch control → p.283
- Magnified view → p.290
- Manual focusing → p.291
- Silent LV shooting → p.281

Movie Shooting

- Movie shooting → p.295
- ISO speed (movie) → p.330
- AF method → p.284
- Movie Servo AF → p.331
- Movie Servo AF speed → p.334
- Movie Servo AF tracking sensitivity → p.335
- LV touch control → p.336
- Movie recording quality → p.311
- 24.00p → p.317
- High Frame Rate movie → p.318
- Sound recording → p.322
- Microphone → p.323

- Line input → p.322
- Headphones → p.324
- Wind filter → p.323
- Attenuator → p.323
- Silent control → p.325
- Time code → p.326
- HDMI output → p.338

Playback

- Image review time → p.77
- Single-image display → p.344
- Shooting information display → p.347
- Index display → p.352
- Image browsing (Jump display) → p.353
- Magnified view → p.355
- Image rotate → p.357
- Protect → p.358
- Rating → p.361
- Voice memo → p.363
- Movie playback → p.369
- Editing a movie's first and last scenes → p.372
- Frame Grab (4K) → p.374
- Slide show → p.376
- Viewing images on a TV set → p.379
- Copying → p.382
- Erasing → p.386
- Quick Control → p.365

Image Editing

- RAW image processing → p.392
- Resizing JPEGs → p.397
- Cropping JPEGs → p.399

Image Transfer / Print Ordering

- Image transfer → p.408
- Print Order (DPOF) → p.413

Wired LAN

- Wired LAN Instruction Manual

Customization

- Custom Functions (C.Fn) → p.418
- Custom Controls → p.443
- Custom Quick Control → p.459
- My Menu → p.463
- Saving camera settings → p.468
- Custom shooting mode → p.472

Sensor Cleaning and Dust Reduction

- Sensor cleaning → p.402
- Append Dust Delete Data → p.403
- Manual sensor cleaning → p.405

Interface

- Cable protector → p.38

Errors / Cautions

- Camera system information → p.520
- Error codes → p.523

Software

- Overview → p.550
- Installation → p.551
- Instruction Manual → p.4

Safety Precautions

The following precautions are provided to prevent harm or injury to yourself and others. Make sure to thoroughly understand and follow these precautions before using the product.

If you experience any malfunctions, problems, or damage to the product, contact the nearest Canon Service Center or the dealer from whom you purchased the product.



Warnings: Follow the warnings below. Otherwise, death or serious injuries may result.

- To prevent fire, excessive heat, chemical leakage, explosions, and electrical shock, follow the safeguards below:
 - Do not use any batteries, power sources, or accessories not specified in the Instruction Manual. Do not use any home-made or modified batteries, or the product if it is damaged.
 - Do not short-circuit, disassemble, or modify the battery. Do not apply heat or solder to the battery. Do not expose the battery to fire or water. Do not subject the battery to strong physical shock.
 - Do not insert the battery's plus and minus ends incorrectly.
 - Do not recharge the battery in temperatures outside the allowable charging (working) temperature range. Also, do not exceed the recharge time indicated in the Instruction Manual.
 - Do not insert any foreign metallic objects into the electrical contacts of the camera, accessories, connecting cables, etc.
- When disposing of a battery, insulate the electrical contacts with tape. Contact with other metallic objects or batteries may cause a fire or an explosion.
- If excessive heat, smoke, or fumes are emitted when recharging the battery, immediately unplug the battery charger from the power outlet to stop recharging. Otherwise, it may cause a fire, heat damage, or electrical shock.
- If the battery leaks, changes color, deforms, or emits smoke or fumes, remove it immediately. Be careful not to get burned in the process. It may cause a fire, electrical shock or burns if you keep using it.
- Prevent any battery leakage from contacting your eyes, skin, and clothing. It can cause blindness or skin problems. If the battery leakage comes in contact with your eyes, skin, or clothing, flush the affected area with lots of clean water without rubbing it. See a physician immediately.
- Do not leave any cords near a heat source. It can deform the cord or melt the insulation and cause a fire or electrical shock.
- Do not hold the camera in the same position for long periods of time. Even if the camera does not feel too hot, prolonged contact with the same body part may cause skin redness or blistering due to low-temperature contact burns. Using a tripod is recommended for people with circulation problems or very sensitive skin, or when using the camera in very hot places.
- Do not fire the flash at anyone driving a car or other vehicle. It may cause an accident.

- When the camera or accessories are not in use, make sure to remove the battery and disconnect the power plug from the equipment before storing. This is to prevent electrical shock, excessive heat, fire, and corrosion.
- Do not use the equipment where there is flammable gas. This is to prevent an explosion or a fire.
- If you drop the equipment and the casing breaks open to expose the internal parts, do not touch the exposed internal parts. There is a possibility of an electrical shock.
- Do not disassemble or modify the equipment. High-voltage internal parts can cause electrical shock.
- Do not look at the sun or an extremely bright light source through the camera or lens. Doing so may damage your vision.
- Keep equipment out of the reach of children and infants, including when in use. Straps or cords may accidentally cause choking, electrical shock, or injury. Choking or injury may also occur if a child or infant accidentally swallows a camera part or accessory. If a child or infant swallows a part or accessory, consult a physician immediately.
- Do not use or store the equipment in dusty or humid places. Likewise, keep the battery away from metallic items and store it with its protective cover attached to prevent short-circuit. This is to prevent fire, excessive heat, electrical shock, and burns.
- Before using the camera inside an airplane or hospital, check if it is allowed. Electromagnetic waves emitted by the camera may interfere with the plane's instruments or the hospital's medical equipment.
- To prevent a fire and electrical shock, follow the safeguards below:
 - Always insert the power plug all the way in.
 - Do not handle a power plug with wet hands.
 - When unplugging a power plug, grasp and pull the plug instead of the cord.
 - Do not scratch, cut, or excessively bend the cord or put a heavy object on the cord. Also do not twist or tie the cords.
 - Do not connect too many power plugs to the same power outlet.
 - Do not use a cord whose wire is broken or insulation is damaged.
- Unplug the power plug periodically and clean off the dust around the power outlet with a dry cloth. If the surrounding is dusty, humid, or oily, the dust on the power outlet may become moist and short-circuit the outlet, causing a fire.
- Do not connect the battery directly to an electrical outlet or a car's cigarette lighter outlet. The battery may leak, generate excessive heat or explode, causing fire, burns, or injuries.
- A thorough explanation of how to use the product by an adult is required when the product is used by children. Supervise children while they are using the product. Incorrect usage may result in electrical shock or injury.
- Do not leave a lens or lens-attached camera in the sun without the lens cap attached. Otherwise, the lens may concentrate the sun's rays and cause a fire.
- Do not cover or wrap the product with a cloth. Doing so may trap heat within and cause the casing to deform or catch fire.
- Be careful not to get the camera wet. If you drop the product in the water or if water or metal get inside the product, promptly remove the battery. This is to prevent fire, electrical shock, and burns.
- Do not use paint thinner, benzene, or other organic solvents to clean the product. Doing so may cause fire or a health hazard.



Cautions: Follow the cautions below. Otherwise, physical injury or property damage may result.

- Do not use or store the product in a high-temperature location such as inside a car under the hot sun. The product may become hot and cause burns. Doing so may also cause battery leakage or explosion, which will degrade the performance or shorten the life of the product.
- Do not carry the camera around when it is attached to a tripod. Doing so may cause an injury or an accident. Also make sure the tripod is sturdy enough to support the camera and lens.
- Do not leave the product in a low-temperature environment for an extended period of time. The product will become cold and may cause injury when touched.
- Do not fire the flash near the eyes. It may hurt the eyes.
- Never play the provided CD-ROM in a drive that is not compatible with the CD-ROM. If you use it in a music CD player, you may damage the speakers and other components. When using headphones, there is also a risk of injury to your ears from excessively loud volume.
- While listening with headphones, do not change the sound-recording settings. Doing so may cause a blast of loud sound that will hurt your ears.

Handling Precautions

Camera Care

- This camera is a precision instrument. Do not drop it or subject it to physical shock.
- The camera is not waterproof and cannot be used underwater. If you accidentally drop the camera into water, promptly consult the nearest Canon Service Center. Wipe off any water droplets with a dry and clean cloth. If the camera has been exposed to salty air, wipe it with a clean, well-wrung wet cloth.
- Never leave the camera near anything having a strong magnetic field such as a magnet or electric motor. Also, avoid using or leaving the camera near anything emitting strong radio waves, such as a large antenna. Strong magnetic fields can cause camera misoperation or destroy image data.
- Do not leave the camera in excessive heat, such as in a car in direct sunlight. High temperatures can cause the camera to malfunction.
- The camera contains precision electronic circuitry. Never attempt to disassemble the camera yourself.
- Do not block the mirror operation with your finger, etc. Doing so may cause a malfunction.
- Use only a commercially-available blower to blow away dust when it adheres to the lens, viewfinder, reflex mirror, focusing screen, etc. Do not use cleaners that contain organic solvents to clean the camera body or lens. For stubborn dirt, take the camera to the nearest Canon Service Center.
- Do not touch the camera's electrical contacts with your fingers. This is to prevent the contacts from corroding. Corroded contacts can cause camera malfunction.
- If the camera is suddenly brought in from the cold into a warm room, condensation may form on the camera and internal parts. To prevent condensation, first put the camera in a sealed plastic bag and let it adjust to the warmer temperature before taking it out of the bag.

- If condensation forms on the camera, do not use the camera. This is to avoid damaging the camera. If there is condensation, remove the lens, card and battery from the camera, and wait until condensation has evaporated before using the camera.
- If the camera will not be used for an extended period, remove the battery and store the camera in a cool, dry, well-ventilated location. Even while the camera is in storage, press the shutter button a few times once in a while to check that the camera is still working.
- Avoid storing the camera where there are chemicals that result in rust and corrosion such as in a chemical lab.
- If the camera has not been used for an extended period, test all its functions before using it. If you have not used the camera for some time or if there is an important shoot such as a foreign trip coming up, have the camera checked by your nearest Canon Service Center or check the camera yourself and make sure it is working properly.
- If you use continuous shooting, Live View shooting, or movie shooting for a prolonged period, the camera may become hot. This is not a malfunction.
- If there is a bright light source inside or outside the image area, ghosting may occur.

LCD Panel and LCD Monitor

- Although the LCD monitor is manufactured with very high precision technology with over 99.99% effective pixels, there may be a few dead pixels displaying only black or red, etc. among the remaining 0.01% or less pixels. Dead pixels are not a malfunction. They do not affect the images recorded.
- If the LCD monitor is left on for a prolonged period, screen burn-in may occur where you see remnants of what was displayed. However, this is only temporary and will disappear when the camera is left unused for a few days.
- The LCD monitor display may seem slightly slow in low temperatures, or look black in high temperatures. It will return to normal at room temperature.

Cards

To protect the card and its recorded data, note the following:

- Do not drop, bend, or wet the card. Do not subject it to excessive force, physical shock, or vibration.
- Do not affix any stickers, etc., on the card.
- Do not store or use the card near anything that has a strong magnetic field, such as a TV set, speakers, or magnets. Also avoid places prone to having static electricity.
- Do not leave the card in direct sunlight or near a heat source.
- Store the card in a case.
- Do not store the card in hot, dusty, or humid locations.

Lens

After detaching the lens from the camera, put down the lens with the rear end up and attach the rear lens cap to avoid scratching the lens surface and electrical contacts.

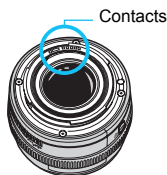

Nomenclature

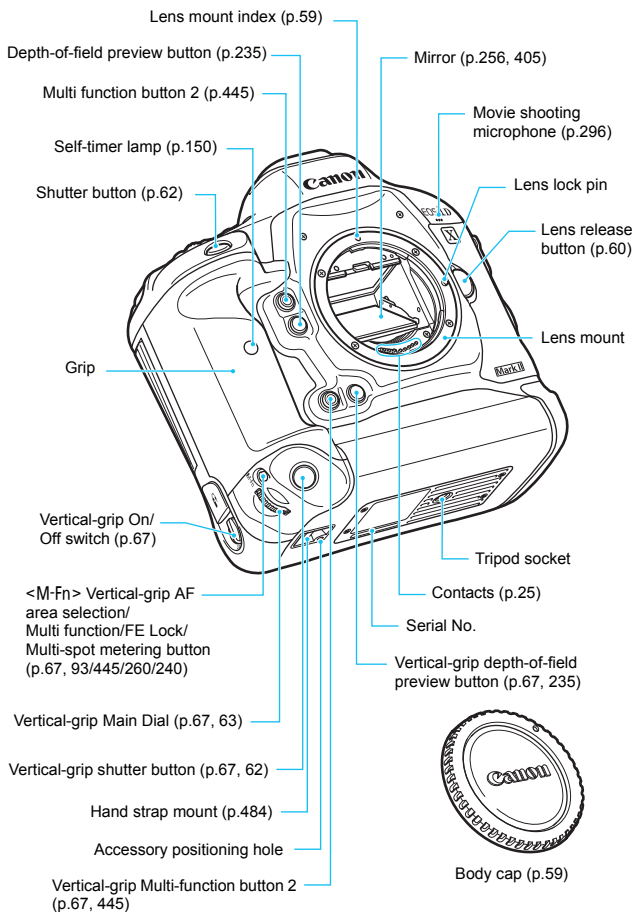

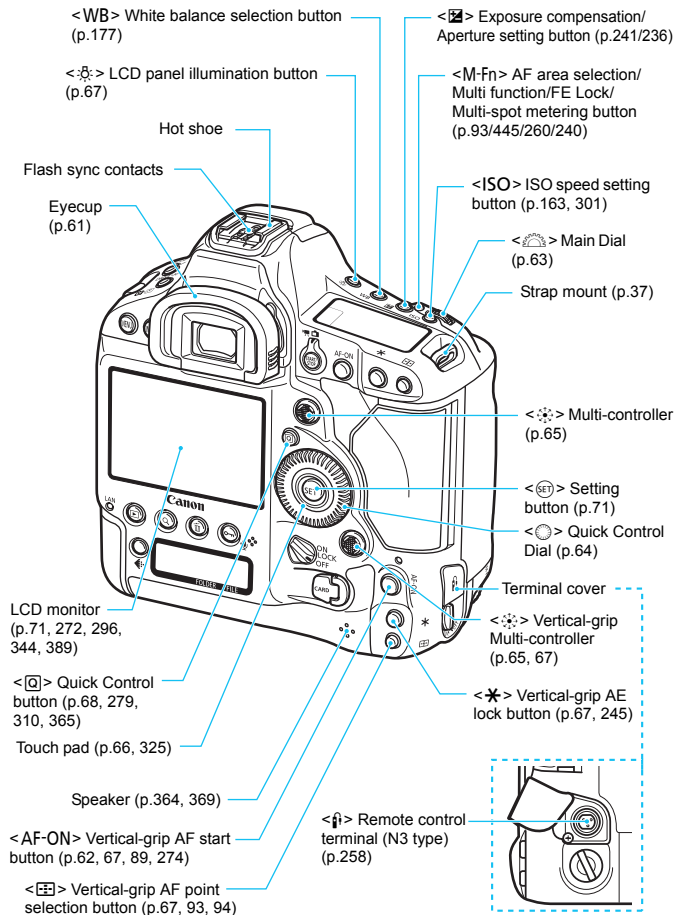

< > Flash exposure compensation/Metering mode selection button (p.260/238)

<MODE> Shooting mode selection button (p.228, 272, 296)

<DRIVE•AF> Drive mode selection/AF operation/AF method selection button (p.146/88/284)

< > AEB setting button (p.243)

System extension mounting hole

Terminal cover

System extension terminal

<MIC> External microphone IN/Line input terminal (p.323)

< > Headphone terminal (p.324)

< > PC terminal (p.261)

Top LCD panel (p.32, 33)

< > Live View shooting/ Movie shooting switch (p.272/295)
< > Start/Stop button (p.272, 296)

<AF-ON> AF start button (p.62, 89, 274)

< > AE lock button (p.245)

< > AF point selection button (p.93, 94)

Eyepiece shutter lever (p.258)

Viewfinder eyepiece

Dioptric adjustment knob (p.61)

< > Ethernet RJ-45 terminal (→ Wired LAN Instruction Manual)

< **HDMI** > HDMI mini OUT terminal (p.379)

< **DIGITAL** > Digital terminal (p.408)

When connecting the interface cable to a digital terminal, use the provided cable protector (p.38).

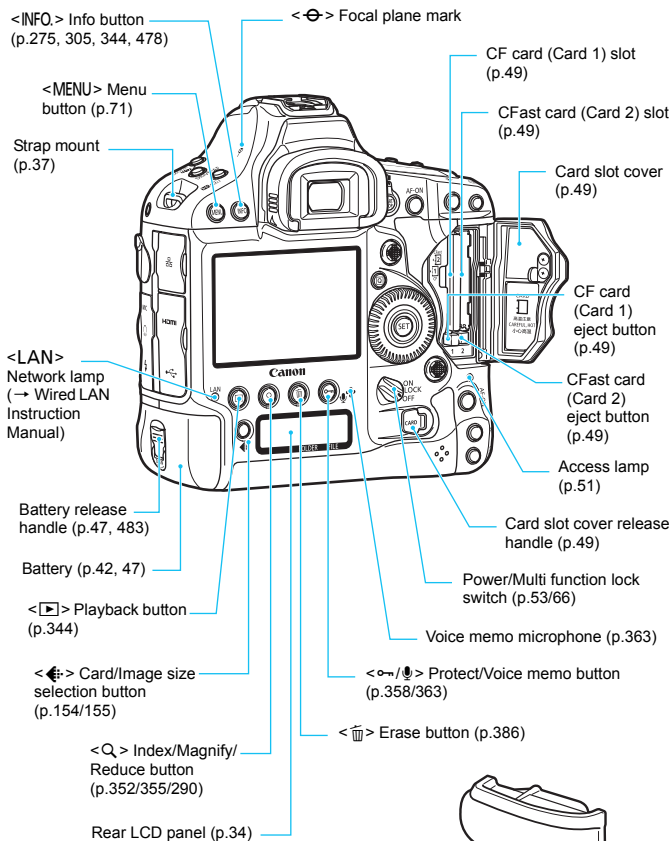

Battery compartment cap (p.47)

Viewfinder Information

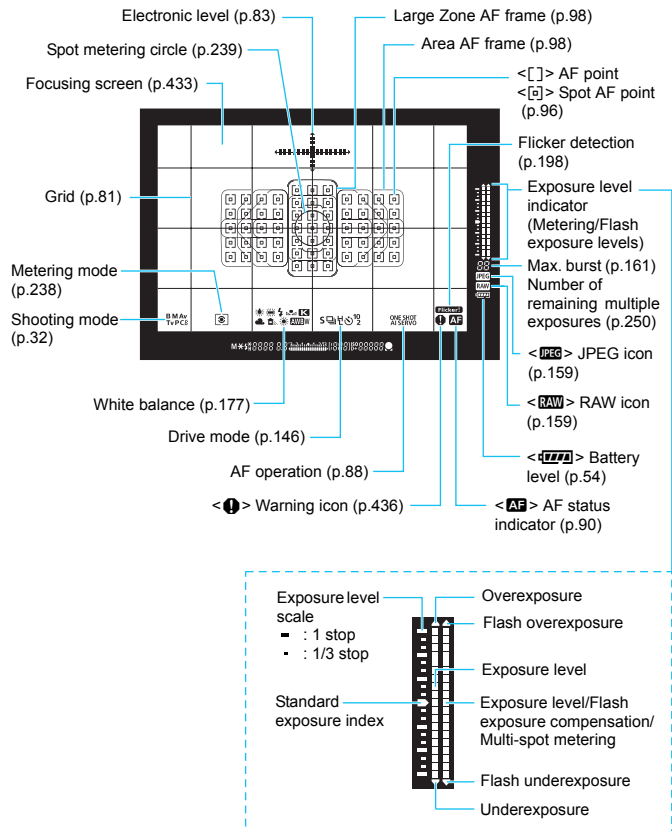

* The display will show only the settings currently applied.

* The AF points light up in red.

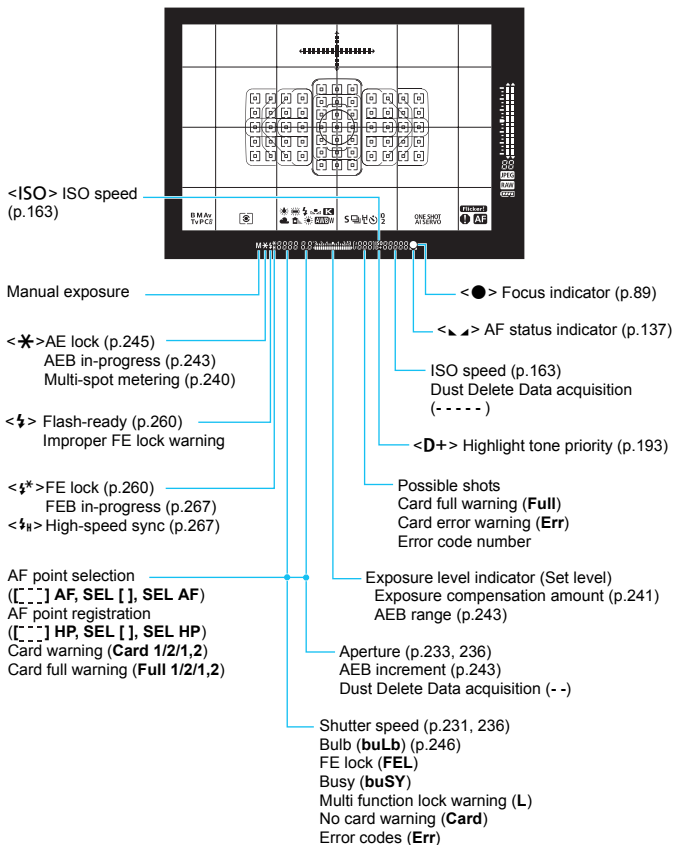

Top LCD Panel

Shutter speed
 Bulb (**buLb**)
 Bulb exposure time (min.:sec.)
 FE lock (**FEL**)
 Busy (**buSY**)
 Multi function lock warning (**L**)
 Cleaning image sensor (**CLn**)
 No card warning (**Card**)
 Error codes (**Err**)

Shooting mode
P Program AE
 (p.228, 296)
Av Aperture-priority AE
 (p.233, 298)
M Manual exposure
 (p.236, 301)
Tv Shutter-priority AE
 (p.231, 297)
C1/C2/C3
 Custom shooting mode
 (p.472)

Aperture
 AEB increment
 Dust Delete Data acquisition (- -)

AF point selection
 ([] AF, SEL [], SEL AF)
 AF point registration
 ([] HP, SEL [], SEL HP)
 Card warning (**Card 1/2/1,2**)
 Card full warning (**Full 1/2/1,2**)

Possible shots
 Self-timer countdown
 Bulb exposure time (Hours)
 Custom white balance
 Acquisition display ([*])
 Card full warning (**Full**)
 Card error warning (**Err**)
 Error code number
 Remaining images to record

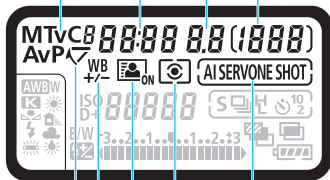

<  > Mirror lockup (p.256)

<  > White balance correction
 (p.186)

<  > Auto Lighting Optimizer
 (p.189)

AF operation (p.88)
ONE SHOT One-Shot AF
AI SERVO AI Servo AF

Metering mode (p.238)

- Evaluative metering
- Partial metering
- Spot metering
- Center-weighted average metering

* The display will show only the settings currently applied.

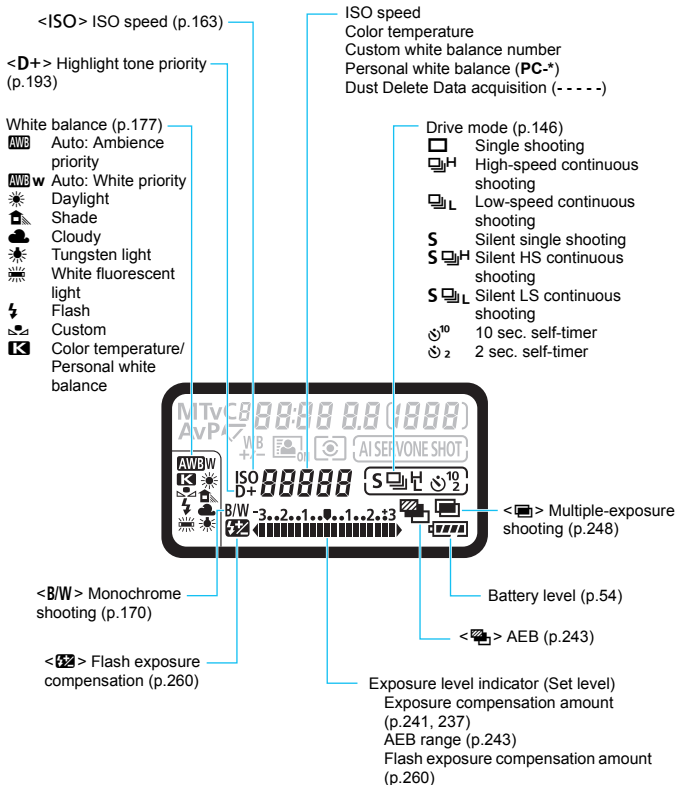

Rear LCD Panel

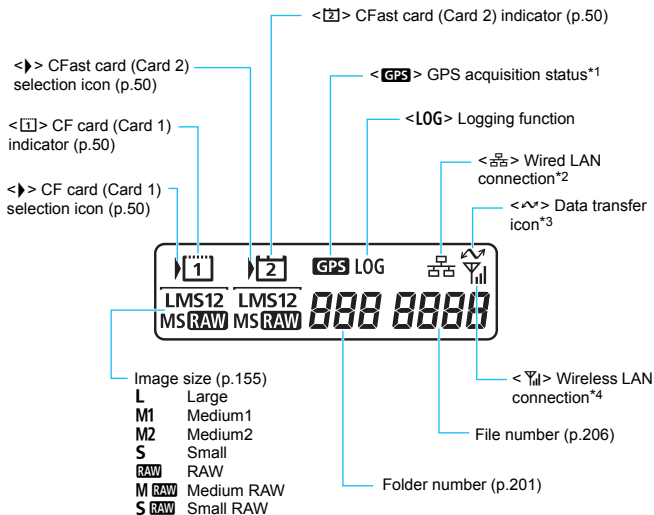

*1: Appears when the built-in GPS is used.

*2: Appears when the camera is connected to a wired LAN.

*3: Appears when a computer or smartphone is connected.

*4: Appears when the camera is connected to a wireless LAN via Wireless File Transmitter WFT-E8/WFT-E6.

* The display will show only the settings currently applied.

Battery Pack LP-E19

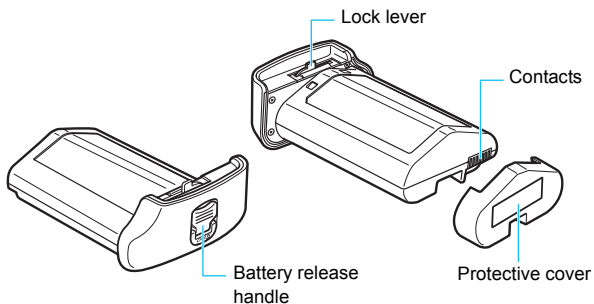

To charge the provided Battery Pack LP-E19, use the provided Battery Charger LC-E19 (p.36). Battery Pack LP-E19 cannot be charged with Battery Charger LC-E4N/LC-E4.



Battery Pack LP-E19 is also compatible with cameras that use Battery Pack LP-E4N/LP-E4.

Battery Charger LC-E19

Charger for Battery Pack LP-E19 (p.42).

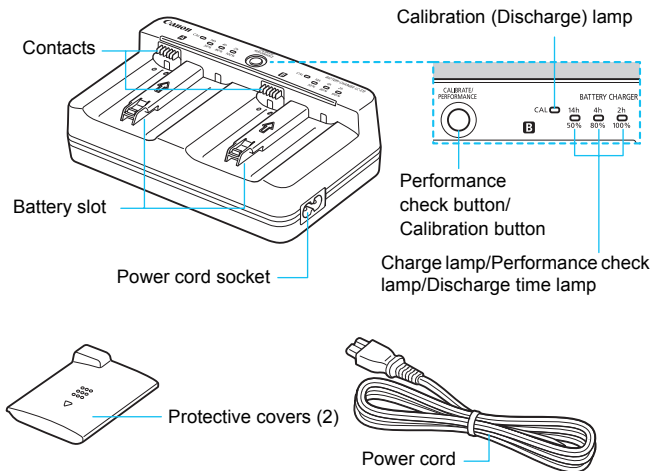

 Provided Battery Charger LC-E19 can also charge Battery Pack LP-E4/LP-E4.

Attaching the Strap

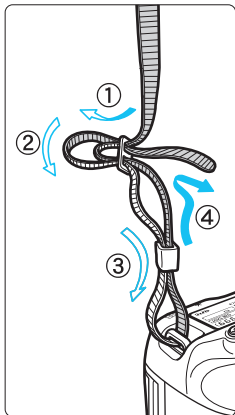

Pass the end of the strap through the camera's strap mount eyelet from the bottom. Then pass it through the strap's buckle as shown in the illustration. Pull the strap to take up any slack and make sure the strap will not loosen from the buckle.

Using the Cable Protector

When connecting the camera to a computer or the Connect Station, use the provided interface cable or one from Canon (shown in the System Map on page 485).

When connecting the interface cable, also use the provided cable protector. Using the cable protector prevents the cable from accidental disconnection and the terminal from getting damaged.

Using the Provided Interface Cable and a Genuine HDMI Cable (sold separately)

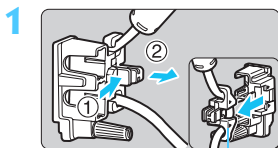

Clamp

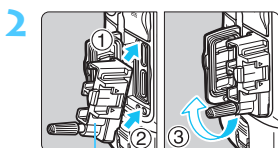

Cable protector

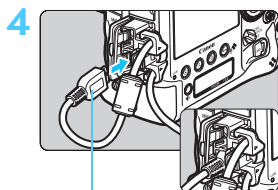
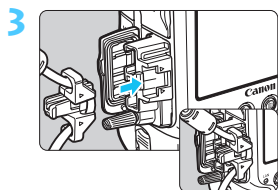

Provided interface cable

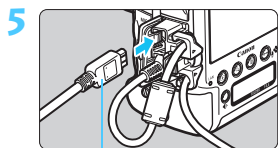

HDMI cable (sold separately)

Using a Genuine Interface Cable (sold separately)

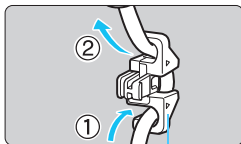

Clamp

If you use a genuine interface cable (sold separately, p.485), run the cable through the clamp before attaching the clamp to the cable protector.



- Connecting interface cable without using the cable protector may damage the digital terminal.
- Do not use a USB 2.0 cable equipped with a Micro-B plug. It may damage the camera's digital terminal.
- As shown in the lower-right illustration for step 4, check that the interface cable is securely attached to the digital terminal.



To connect the camera to a TV set, using HDMI Cable HTC-100 (sold separately) is recommended. Using the cable protector is also recommended when connecting an HDMI cable.



1

Getting Started

This chapter explains preparatory steps before you start shooting and the basic camera operations.

Charging the Battery

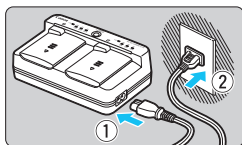

1 Connect the charger to a power outlet.

- Connect the power cord to the charger and insert the power plug into a power outlet.
- When no battery is attached, all the indicator lamps will be off.

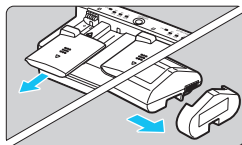

2 Remove the protective cover.

- As shown in the illustration, detach the charger's protective cover (provided) and the battery's protective cover (provided).

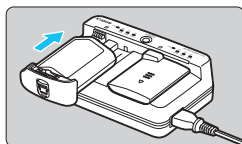

3 Recharge the battery.

- Slide the battery into the charger's slot as shown by the arrow, and make sure it is securely attached.
- You can attach the battery to either slot **A** or slot **B**.
 - ▶ Charging will start and the charge lamp will blink or light up in green.
 - ▶ **When all three charge lamps light up in green (50%/80%/100%), the charging is complete.**

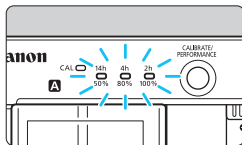

- **To recharge a fully exhausted battery at room temperature (23 °C / 73 °F), it takes approx. 2 hr. 50 min. for the LP-E19 and approx. 2 hr. 20 min. for the LP-E4N/LP-E4.** (The battery recharge time varies widely depending on the ambient temperature and the battery's remaining capacity.)
- For safety reasons, recharging in low temperatures (5°C - 10°C / 41°F - 50°F) will take a longer time (up to approx. 5 hours only when charging Battery Pack LP-E19).



- If two batteries are attached to the charger, the battery attached first will be charged first, then the other battery will be charged.
- Provided Battery Charger LC-E19 can also charge Battery Pack LP-E4N/LP-E4.



- To charge the provided Battery Pack LP-E19, use the provided Battery Charger LC-E19. Battery Pack LP-E19 cannot be charged with Battery Charger LC-E4N/LC-E4.
- Provided Battery Charger LC-E19 can only charge provided Battery Pack LP-E19 and Battery Pack LP-E4N/LP-E4.
- Depending on the battery's condition, it may not reach a 100% charge.



Tips for Using the Battery and Charger

- **Upon purchase, the battery is not fully charged.**
Charge the battery before use.
- **Recharge the battery on the day before or on the day it is to be used.**
Even during storage, a charged battery will gradually drain and lose its capacity.
- **After recharging the battery, detach it and disconnect the charger from the power outlet.**
When not using the battery and charger, attach the protective covers provided.
- **Use the battery in an ambient temperature range of 0°C - 45°C / 32°F - 113°F.**
To attain best battery performance, an ambient temperature of 10°C - 30°C / 50°F - 86°F is recommended. In low temperatures, battery performance and operation time of the camera may temporarily decrease.
- **When not using the camera, remove the battery.**
If the battery is left in the camera for a prolonged period, a small amount of power current is released, resulting in excess discharge and shorter battery life. Store the battery with the protective cover attached. Storing the battery when it is fully charged may lower the battery's performance.

- **The battery charger can also be used in foreign countries.**

The battery charger is compatible with a 100 V AC to 240 V AC 50/60 Hz power source. If necessary, attach a commercially-available plug adapter for the respective country or region. Do not attach any portable voltage transformer to the battery charger. Doing so can damage the battery charger.

- **Check the battery performance.**

While the battery is recharging, press the charger's <PERFORMANCE> button to check the battery's performance level indicated by the charge level indicator.

- ● ● : Battery's recharge performance is fine.

- ● ○ : Battery's recharge performance is slightly degraded.

- ○ ○ : Purchasing a new battery is recommended.

- **If the battery becomes exhausted quickly even after being fully charged, the battery has reached the end of its service life.**

Check the battery's recharge performance (p.44, 482) and purchase a new battery.

? The <CAL> lamp blinks

- This is a recommendation that you calibrate (discharge) the battery so that the camera can accurately determine its capacity and display its battery level accurately.
 - It is recommended that you perform calibration if the <CAL> lamp blinks in green. If you want to just recharge the battery, you can let the battery start recharging automatically after approx. 10 sec.
 - If you want to do the calibration, press the <CALIBRATE> button while the <CAL> lamp is blinking in green. When the <CAL> lamp lights up in green, the battery will start to discharge.
 - After the battery is finished discharging, the battery will start recharging automatically. Note that the less depleted the battery, the longer the discharging will take. The <14h>, <4h>, and <2h> figures respectively indicate the approximate number of hours it will take to complete the power discharge. If the <14h> indicator blinks in green, it will take approx. 4 up to approx. 16 hours to complete the discharge.
 - The calibration (power discharge) will completely drain the battery's power. Therefore, it will take approx. 2 hr. 50 min. to fully charge the LP-E19. If you want to stop the calibration before it is completed and start recharging the battery, remove the battery from the charger and attach it again.
-
- If the battery is recharged and used repeatedly without calibration, the battery level (p.54) may not be displayed accurately.
 - Although one battery can be recharged and another calibrated at the same time, two batteries cannot be recharged or calibrated at the same time.
 - For battery calibration, performing with a battery nearly exhausted is recommended. When calibrating a fully-charged Battery Pack LP-E19, it will take approx. 18 hr. 50 min. before calibration is complete and the battery is recharged. With the same charge status, it will take approx. 15 hr. 20 min. with the LP-E4N, and approx. 14 hr. 20 min. with the LP-E4.

? Right after attaching the battery, only the lamp with the <100%> mark lights up

- If the charging starts and only the lamp with the <100%> mark lights up in green right away, it means the battery's internal temperature is outside the required temperature range. The battery will start recharging automatically when the internal temperature is within the range of 5°C - 40°C / 41°F - 104°F.
- When two batteries are attached to the charger and only the lamp with the <100%> mark on the second battery side lights up in green, it indicates that it is in a waiting status.

? All three charge lamps blink

- The charger cannot charge batteries other than the provided LP-E19 and LP-E4N/LP-E4. The three charge lamps and <CAL> lamp will blink in green.
- While charging a battery, if the three charge lamps blink in green consecutively or if they blink consecutively in green with the <CAL> lamp blinking in green, remove the battery from the charger. Contact your dealer or the nearest Canon Service Center.
- If the three charge lamps blink during calibration, remove the battery from the charger. Contact your dealer or the nearest Canon Service Center.

Installing and Removing the Battery

Load a fully-charged Battery Pack LP-E19 or LP-E4N/LP-E4 into the camera.

The camera's viewfinder becomes bright when a battery is installed, and darkens when the battery is removed. Also, when the camera has no battery, the viewfinder image will look blurred and you cannot focus.

Installing the Battery

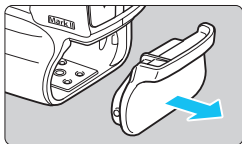

- 1 Remove the battery compartment cap.

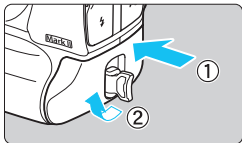

- 2 Insert the battery.
 - Insert the battery firmly all the way, and turn the battery release handle as shown by the arrow.

- When using a battery that has not been used in the camera before, it may take some time for the camera to turn on.
- The camera cannot use batteries other than the provided Battery Pack LP-E19 or LP-E4N/LP-E4.

- ⚠ If the battery's rubber lining (to repel water) is dirty, use a moist cotton swab to wipe it clean.

Rubber lining



Removing the Battery

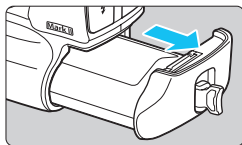
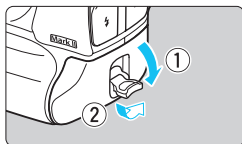

Turn the battery release handle and take out the battery.

- Check that the power switch is set to <OFF> (p.53).
- Flip out the battery release handle, turn it as shown by the arrow, and pull it out.
- To prevent short circuiting of the battery contacts, be sure to attach the provided protective cover (p.42) to the battery.
- When not using the camera, attach the battery compartment cap (p.29).

Compatible Batteries

The Battery Pack LP-E19 (provided) or the Battery Pack LP-E4N/LP-E4 can be used with the camera. The camera can also use the household power outlet accessories (sold separately, p.483).

Note that the maximum continuous shooting speed will vary depending on the battery (power source), shooting conditions (viewfinder shooting or Live View shooting), ISO speed, battery level, battery temperature, etc. For details, see page 148.

Installing and Removing the Card

You can use CF cards and CFast cards with this camera. **Images can be recorded when at least one card is installed in the camera.**

If cards are inserted in both slots, you can select which card to record images to or record the same images simultaneously on both cards (p.152).

Installing the Card

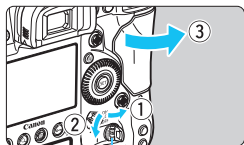

Cover release handle

1 Open the cover.

- Lift the card slot cover release handle and turn it in the direction of the arrow to open the cover.

CF card (Card 1)

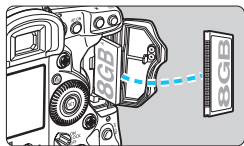

2 Insert the card.

- The left slot is for CF cards, and the right slot is for CFast cards.
- The CF card is [1] (Card 1) and the CFast card is [2] (Card 2).
- **With the CF card's label side facing you, insert the end with the small holes into the camera. If the card is inserted in the wrong way, it may damage the camera.**

▶ The CF card eject button (gray) will stick out.

CFast card (Card 2)

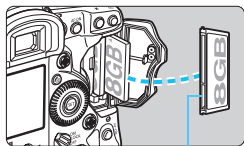

Smaller groove

- **Insert the CFast card into the slot, with the smaller of the two grooves on its edge facing down, and push in the card. If the card is inserted in the wrong way, it may damage the camera.**

▶ The CFast card eject button (orange) will stick out.

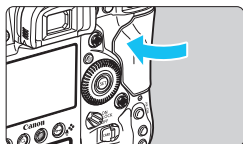

3 Close the cover.

- Press the cover until it snaps shut.

Possible shots

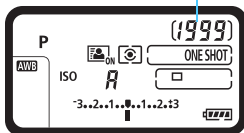

4 Set the power switch to <ON> (p.53).

- ▶ The number of possible shots will be displayed on the top LCD panel.
- ▶ The rear LCD panel will indicate which card(s) has been installed.

The images will be recorded to the card indicated by the arrow <▶> icon.

Card selection icon

CF card indicator

CFast card indicator



 The camera cannot use Type II CF cards or hard disk cards.

- Ultra DMA (UDMA) CF cards can also be used with the camera. UDMA cards enable faster data writing.
- The number of possible shots varies depending on the remaining capacity of the card, image-recording quality, ISO speed, etc.
- Even if the actual number of possible shots is 2000 or higher, “1999” will be displayed on the top LCD panel.
- Setting [ 3: **Release shutter without card**] to [**Disable**] will prevent you from forgetting to insert a card (p.491).

Removing the Card

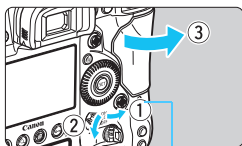

Access lamp

1 Open the cover.

- Set the power switch to <OFF>.
- **Check that the access lamp is off, then open the cover.**
- If [Recording...] is displayed on the LCD monitor, close the cover.

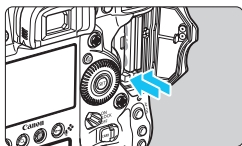

2 Remove the card.

- Push the eject button to eject the card.
- Pull the card straight out, then close the cover.

Caution

During Live View shooting or movie shooting, if the red icon  appears, do not remove the card right away. The card may be hot due to the camera's high internal temperature. Set the power switch to <OFF> and stop shooting for a while. Then remove the card. If you take out the card while it is still hot after shooting, you may drop the card and damage it. Be careful when taking out the card.



- **When the access lamp is lit or blinking, it indicates that images are being written to, read from, or erased from the card, or data is being transferred. Do not open the card slot cover during this time. Also, never do any of the following while the access lamp is lit or blinking. Otherwise, it can damage the image data, card, or camera.**
 - **Removing the card.**
 - **Removing the battery.**
 - **Shaking or banging the camera around.**
 - **Unplugging and connecting a power cord** (when household power outlet accessories (sold separately, p.483) are used).
- If the card already contains recorded images, the image number may not start from 0001 (p.206).
- If a card-related error message is displayed on the LCD monitor, remove and reinsert the card. If the error persists, use a different card. If you can transfer images on the card to a computer, transfer all the images and then format the card with the camera (p.74). The card may then return to normal.

Turning on the Power

If you turn on the power switch and the date/time/zone setting screen appears, see page 55 to set the date/time/zone.

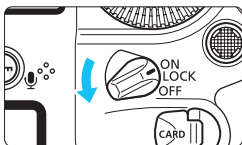

- <ON> : The camera turns on.
- <LOCK>: The camera turns on. The Multi function lock will take effect (p.66).
- <OFF> : The camera is turned off and does not function. Set to this position when not using the camera.

Automatic Sensor Cleaning

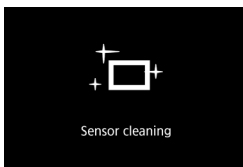

- Whenever you set the power switch to <ON/LOCK> or <OFF>, sensor cleaning will be performed automatically. (A small sound may be heard.) During the sensor cleaning, the LCD monitor will display <  >.

- You can still shoot during sensor cleaning by pressing the shutter button halfway (p.62) to stop cleaning and take a picture.
- If you turn on/off the power switch <ON/LOCK><OFF> at a short interval, the <  > icon may not be displayed. This is normal and not a malfunction.

MENU Auto Power Off

- To save battery power, the camera turns off automatically after approx. 1 minute of non-operation. To turn on the camera again, just press the shutter button halfway (p.62).
- You can change the auto power off time with [**F2: Auto power off**] (p.76).









If you set the power switch to <OFF> while an image is being recorded to the card, [Recording...] will be displayed and the power will turn off after the recording finishes.

Battery Level Indicator

When the power switch is set to <ON>, the battery level will be indicated in one of six levels. A blinking battery icon < > indicates that the battery will soon be exhausted.



Display			
Level (%)	100 - 70	69 - 50	49 - 20
Display			
Level (%)	19 - 10	9 - 1	0

Number of Possible Shots

Temperature	Room Temperature (23°C / 73°F)	Low Temperatures (0°C / 32°F)
Possible shots	Approx. 1210 shots	Approx. 1020 shots

- The figures above are based on a fully-charged Battery Pack LP-E19, no Live View shooting, and CIPA (Camera & Imaging Products Association) testing standards.



- Doing any of the following will exhaust the battery faster:
 - Pressing the shutter button halfway for a prolonged period.
 - Activating the AF frequently without taking a picture.
 - Using the lens's Image Stabilizer.
 - Using the LCD monitor frequently.
- The number of possible shots may decrease depending on the actual shooting conditions.
- The lens operation is powered by the camera's battery. Certain lenses may exhaust the battery faster than others.
- For the number of possible shots with Live View shooting, see page 273.
- See [**3: Battery info.**] to check the battery condition (p.482).

MENU Setting the Date, Time, and Zone

When you turn on the power for the first time or if the date/time/zone have been reset, the date/time/zone setting screen will appear. Follow the steps below to set the time zone first. Set the camera to the time zone in which you currently live so that, when you travel, you can simply change the setting to the correct time zone for your destination, and the camera will automatically adjust the date/time.

Note that the date/time appended to recorded images will be based on this date/time setting. Be sure to set the correct date/time.



1 Display the menu screen.

- Press the <MENU> button to display the menu screen.

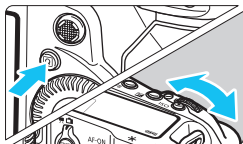

2 Under the [Q] tab, select [Date/Time/Zone].

- Press the <Q> button and select the [Q] tab.
- Turn the <DIAL> dial to select the [2] tab.
- Turn the <DIAL> dial to select [Date/Time/Zone], then press <SET>.

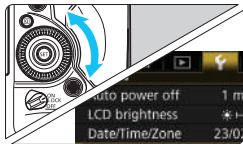

3 Set the time zone.

- [London] is set by default.
- Turn the <DIAL> dial to select [Time zone], then press <SET>.

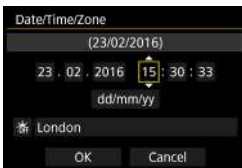
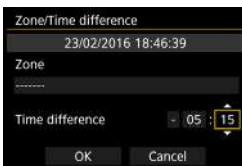
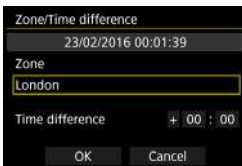

- Turn the <⊙> dial to select [**Zone**], then press <SET>.
- Turn the <⊙> dial to select the time zone, then press <SET>.
- If your desired time zone is not listed, press the <MENU> button, then proceed to the next step to set it (with the time difference from the Coordinated Universal Time, UTC).
- To set the time difference from UTC, turn the <⊙> dial and select (+/- hour/minute) for [**Time difference**].
- Press <SET> so <⊙> is displayed.
- Turn the <⊙> dial to set, then press <SET> (Returns to <□>).
- After entering the time zone and time difference, turn the <⊙> dial to select [**OK**], then press <SET>.

4 Set the date and time.

- Turn the <⊙> dial to select an item.
- Press <SET> so <⊙> is displayed.
- Turn the <⊙> dial to set, then press <SET> (Returns to <□>).

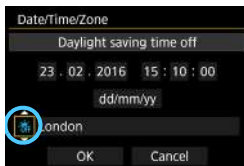

5 Set the daylight saving time.

- Set it if necessary.
- Turn the <☀> dial to select [**☀**].
- Press <SET> so <☀> is displayed.
- Turn the <☀> dial to select [**☀**], then press <SET>.
- When the daylight saving time is set to [**☀**], the time set in step 4 will advance by 1 hr. If [**☀**] is set, the daylight saving time will be canceled and the time will go back by 1 hr.

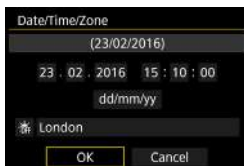

6 Exit the setting.

- Turn the <☀> dial to select [**OK**], then press <SET>.
- ▶ The date/time/zone and daylight saving time will be set and the menu will reappear.



- The date/time/zone settings may be reset when the camera is stored without the battery, when its battery becomes exhausted, or when it is exposed to below freezing temperatures for a prolonged period. If this happens, set the date/time/zone again.
- After changing [**Zone/Time difference**], check that the correct date/time are set.
- When using a wired LAN or wireless file transmitter to [**Sync time between cameras**], it is recommended that you use multiple EOS-1D X Mark II cameras. If you perform [**Sync time between cameras**] using different models, the time zone or time may not be set correctly.



- The date/time that were set will start from when you select [**OK**] in step 6.
- In step 3, the time displayed in [**Time zone**] is the time difference compared with Coordinated Universal Time (UTC).
- Even if [**☿2: Auto power off**] is set to [**1 min.**], [**2 min.**], or [**4 min.**], the auto power off time will be approx. 6 min. when the [**☿2: Date/Time/Zone**] setting screen is displayed.
- Automatic time update is possible with GPS function (p.221).

MENU Selecting the Interface Language



1 Display the menu screen.

- Press the <MENU> button to display the menu screen.

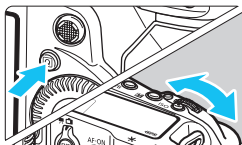

2 Under the [F2] tab, select [Language].

- Press the <Q> button and select the [F2] tab.
- Turn the <DIAL> dial to select the [F2] tab.
- Turn the <DIAL> dial to select [Language], then press <SET>.

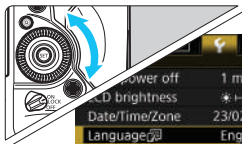

3 Set the desired language.

- Turn the <DIAL> dial to select the language, then press <SET>.
- ▶ The interface language will change.



Attaching and Detaching a Lens

The camera is compatible with all Canon EF lenses. **The camera cannot be used with EF-S or EF-M lenses.**

Attaching a Lens

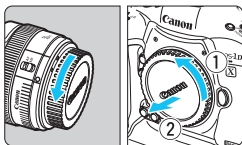

1 Remove the caps.

- Remove the rear lens cap and the body cap by turning them as shown by the arrows.

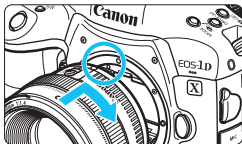

2 Attach the lens.

- Align the red mount index on the lens with the red mount index on the camera and turn the lens as shown by the arrow until it clicks in place.

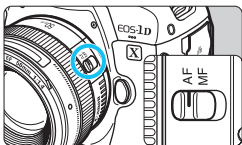

3 Set the lens's focus mode switch to <AF>.

- <AF> stands for autofocus.
- <MF> stands for manual focus. Autofocus will not operate.

4 Remove the front lens cap.

Detaching the Lens

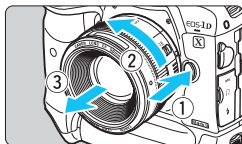

While pressing the lens release button, turn the lens as shown by the arrow.

- Turn the lens until it stops, then detach it.
- Attach the rear lens cap to the detached lens.

- ⚠ Do not look at the sun directly through any lens. Doing so may cause loss of vision.
- When attaching or detaching a lens, set the camera's power switch to <OFF>.
- If the front part (focusing ring) of the lens rotates during autofocusing, do not touch the rotating part.

Minimizing Dust

- When changing lenses, do it quickly in a place with minimal dust.
- When storing the camera without a lens attached, be sure to attach the body cap to the camera.
- Remove dust on the body cap before attaching it.

Basic Operation

Adjusting the Viewfinder Clarity

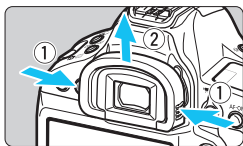

1 Detach the eyecup.

- While grasping both sides of the eyecup, slide it upward to detach it.

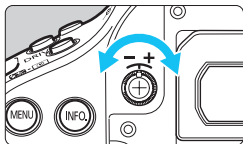

2 Make the adjustment.

- Turn the knob left or right so that the AF points in the viewfinder look sharp.
- Attach the eyecup.



If the camera's dioptic adjustment still cannot provide a sharp viewfinder image, using Dioptic Adjustment Lens Eg (sold separately) is recommended.

Holding the Camera

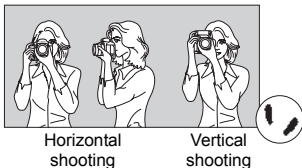

Horizontal shooting

Vertical shooting

To obtain sharp images, hold the camera still to minimize camera shake.

1. Wrap your right hand around the camera grip firmly.
2. Hold the lens bottom with your left hand.
3. Rest your hand's right index finger lightly on the shutter button.
4. Press your arms and elbows lightly against the front of your body.
5. To maintain a stable stance, place one foot slightly ahead of the other.
6. Press the camera against your face and look through the viewfinder.



To shoot while looking at the LCD monitor, see page 271.

Shutter Button

The shutter button has two steps. You can press the shutter button halfway. Then you can further press the shutter button completely.

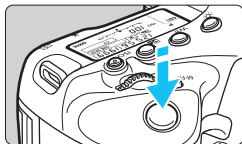

Pressing Halfway

This activates autofocus and the automatic exposure system that sets the shutter speed and aperture.

The exposure setting (shutter speed and aperture) is displayed in the viewfinder and on the top LCD panel for approx. 6 sec. (metering timer/ $\frac{1}{6}$).

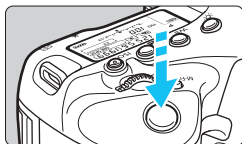

Pressing Completely

This releases the shutter and takes the picture.

● Preventing Camera Shake

Hand-held camera movement during the moment of exposure is called camera shake. It can cause blurred pictures. To prevent camera shake, note the following:

- Hold and steady the camera as shown on the preceding page.
- Press the shutter button halfway to autofocus, then slowly press the shutter button completely.





- Pressing the <AF-ON> button will be the same as pressing the shutter button halfway.
- If you press the shutter button completely without pressing it halfway first, or if you press the shutter button halfway and then press it completely immediately, the camera will take a moment before it takes the picture.
- Even during menu display or image playback, you can go back to shooting-ready state by pressing the shutter button halfway.

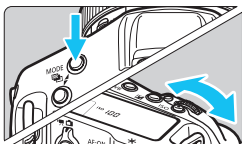

Main Dial



(1) After pressing a button, turn the < > dial.

When you press a button such as <MODE>, <DRIVE•AF>, <•>, or <ISO>, the respective function remains selected for approx. 6 sec. ()6). During this time, you can turn the <> dial to change the setting.

When the function selection timer ends or if you press the shutter button halfway, the camera will be ready to shoot.

- Use the dial to select or set the shooting mode, AF operation, metering mode, AF point, ISO speed, exposure compensation (when the <> button is pressed), card, etc.

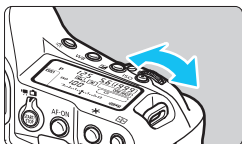

(2) Turn the < > dial only.

While looking at the viewfinder or top LCD panel, turn the <> dial to change the setting.

- Use this dial to set the shutter speed, aperture, etc.





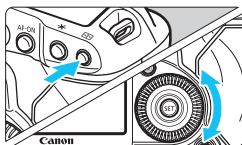

The operations in (1) are possible even when the power switch is set to <LOCK> (Multi function lock, p.66).

Quick Control Dial



(1) After pressing a button, turn the dial.

When you press a button such as <MODE>, <DRIVE•AF>, <•>, or <ISO>, the respective function remains selected for approx. 6 sec. (). During this time, you can turn the  dial to change the setting.

When the function selection timer ends or if you press the shutter button halfway, the camera will be ready to shoot.

- Use the dial to select or set the shooting mode, drive mode, flash exposure compensation, AF point, ISO speed, exposure compensation (when the  button is pressed), white balance, image size, etc.

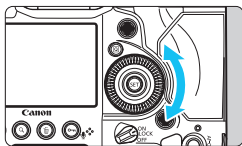



(2) Turn the dial only.

While looking at the viewfinder or top LCD panel, turn the  dial to change the setting.

- Use this dial to set the exposure compensation amount, the aperture setting for manual exposures, etc.

 The operations in (1) are possible even when the power switch is set to <LOCK> (Multi function lock, p.66).

Multi-controller

The  consists of an eight-direction key and a button at the center. Use your thumb to tilt the  in the desired direction.

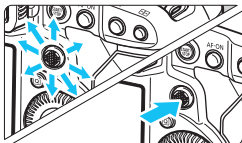

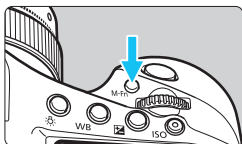

- Use it to select the AF point, correct the white balance, move the AF point or magnifying frame during Live View or movie shooting, scroll around magnified images during playback, set the Quick Control, etc.
- You can also use it to select and set menu items.
- For menus and Quick Control, the Multi-controller works only in the vertical and horizontal directions. It does not work in diagonal directions.

M-Fn Multi Function Button



Use the <M-Fn> button for AF area selection (p.93), FE lock (p.260), multi-spot metering (p.240), and other functions.



To select the AF area, press the  button ()6), then press the <M-Fn> button.

Touch Pad

During movie shooting, the touch pad provides a quiet way to adjust the shutter speed, aperture, exposure compensation, ISO speed, sound-recording level, and headphone volume (p.325).

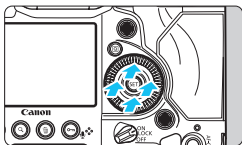
This function works when [**5: Silent Control**] is set to [Enable ].



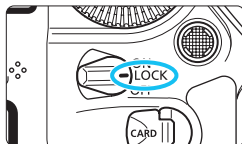

After pressing the  button, tap on the  dial's inner ring at the top, bottom, left, or right.

LOCK Multi Function Lock Switch





With [**6: Multi function lock**] set (p.437) and the power switch set to <LOCK>, it prevents the Main Dial, Quick Control Dial, and Multi-controller from turning or tilting and changing a setting inadvertently.

-  • If the power switch is set to <LOCK> and you try to operate any of the locked camera controls, <L> will appear in the viewfinder and on the top LCD panel. Also, [LOCK] will appear on the Quick Control screen (p.67).
- By default, with the power switch set to <LOCK>, the  dial will be locked.

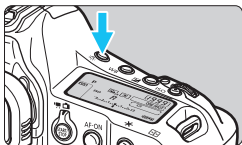
LCD Panel Illumination



You can illuminate the top and rear LCD panels by pressing the  button. Turn on () or off the LCD panel illumination by pressing the  button. During a bulb exposure, pressing the shutter button completely will turn off the LCD panel illumination.

Vertical Shooting

The camera bottom has vertical-grip buttons, a dial, and a Multi-controller (p.26, 27).

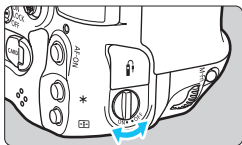

- When using the vertical-grip controls, set the vertical-grip ON/OFF switch to **<ON>**.
- When not using the vertical-grip controls, set the switch to **<OFF>** to prevent accidental operation.

 The vertical grip's Multi function button 2 and aperture button (p.26) will work even when the Vertical-grip ON/OFF switch is set to **<OFF>**.

Displaying the Quick Control Screen

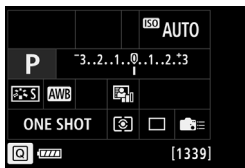

After you press the **<INFO.>** button a number of times (p.478), the Quick Control screen (p.480) or Custom Quick Control screen (p.461) will appear. You can then check the current shooting function settings.

Pressing the **<Q>** button enables Quick Control of the shooting function settings (p.68). Then you can press the **<INFO.>** button to turn off the screen.

Q Quick Control for Shooting Functions

You can directly select and set the shooting functions displayed on the LCD monitor. This is called Quick Control.

The basic operating procedures are the same for the Quick Control screen (p.480) and the Custom Quick Control screen (p.461).

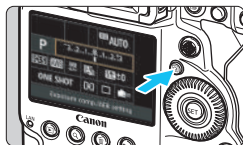

1 Press the **<Q>** button ().

- ▶ The Quick Control screen will appear.

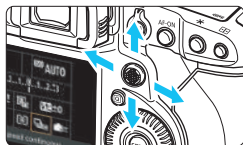

2 Set the desired functions.

- Use **< * >** to select a function.
- ▶ The setting of the selected function is displayed.
- Turn the **< * >** or **<  >** dial to change the setting.



3 Take the picture.

- Press the shutter button completely to take the picture.
- ▶ The captured image will be displayed.

Settable Functions with the Quick Control

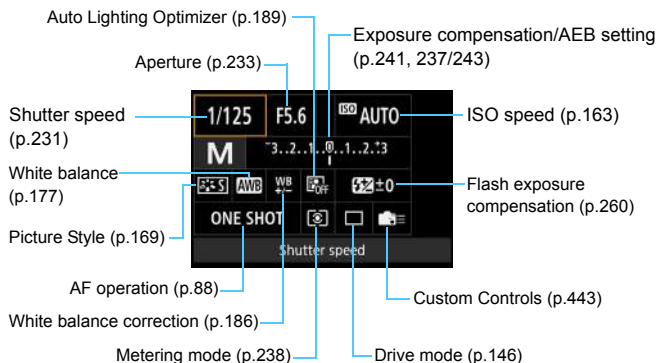

 For the Quick Control screen, see page 480.

Custom Quick Control

You can customize the layout of the Quick Control screen. This feature lets you display and position the shooting functions on the Quick Control screen as desired. This feature is called “Custom Quick Control (screen)”. For the Custom Quick Control, see page 459.

 On the Custom Quick Control screen, if you press the <Q> button and there are no functions you can set with Quick Control, the Quick Control icon on the lower left of the screen will be displayed in orange.

Quick Control



- Select the desired function and press **<SET>**. The function setting screen will appear.
- Turn the **<☀>** or **<☾>** dial to change some of the settings. There are also functions that are set by pressing the button.
- Press **<SET>** to finalize the setting and return to the previous screen.
- When you select **<☰>** (p.443) and press the **<MENU>** button, the previous screen will reappear.

MENU Menu Operations

You can set various settings with the menus such as the image-recording quality, date/time, etc.

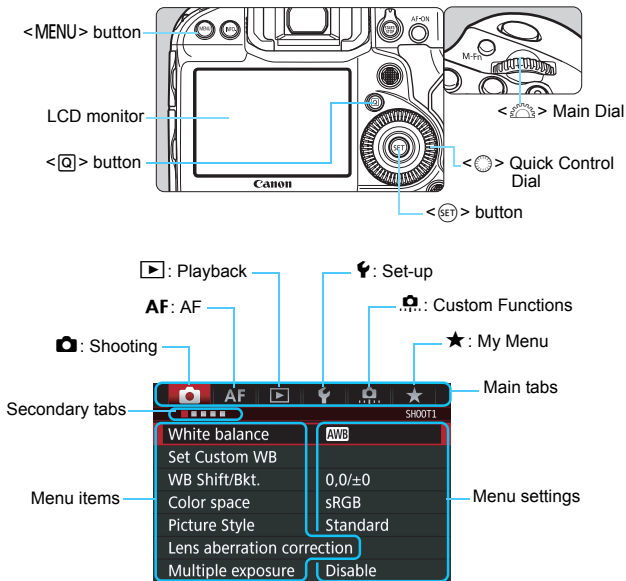

Menu Setting Procedure



1 Display the menu screen.

- Press the <MENU> button to display the menu screen.

2 Select a tab.

- Each time you press the <Q> button, the main tab (group of functions) will switch.
- Turn the <☀> dial to select a secondary tab.
- For example, the [📷4] tab refers to the screen displayed when the 📷 (Shooting) tab's fourth dot "■" from the left is selected.

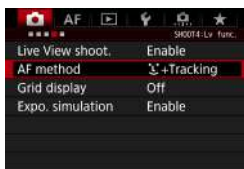

3 Select the desired item.

- Turn the <☀> dial to select the item, then press <SET>.

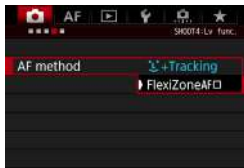

4 Select the setting.

- Turn the <☀> dial to select the desired setting.
- The current setting is indicated in blue.

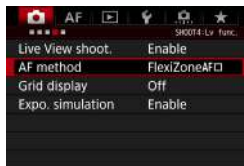

5 Set the setting.

- Press <SET> to set it.

6 Exit the setting.

- Press the <MENU> button to exit the menu and return to shooting-ready.



- The explanation of menu functions hereafter assumes that you have pressed the <MENU> button to display the menu screen.
- You can also use <⏏> to operate and set menu functions. (Except for [▶1: Erase images] and [⏏1: Format card].)
- To cancel the operation, press the <MENU> button.
- For details about each menu item, see page 490.

Dimmed Menu Items

Example: Highlight tone priority

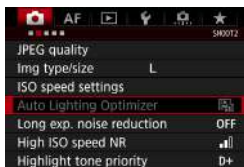

Dimmed menu items cannot be set. The menu item is dimmed if another function setting is overriding it.



You can see the overriding function by selecting the dimmed menu item and pressing <(SET)>.

If you cancel the overriding function's setting, the dimmed menu item will become settable.



Some dimmed menu items will not show the overriding function.



With [⏏4: Clear all camera settings], you can reset the menu functions to the default settings (p.77).

Before You Start

MENU Formatting the Card

If the card is new or was previously formatted by another camera or computer, format the card with this camera.

! When the card is formatted, all images and data on the card will be erased. Even protected images will be erased, so make sure there is nothing you need to keep. If necessary, transfer the images and data to a computer, etc., before formatting the card.



1 Select [Format card].

- Under the [**1**] tab, select [**Format card**], then press <SET>.



2 Select the card.

- [**1**] is the CF card, and [**2**] is the CFast card.
- Select the card, then press <SET>.



3 Format the card.

- Select [**OK**], then press <SET>.
- ▶ The card will be formatted.



Format the card in the following cases:

- The card is new.
- The card was formatted by a different camera or a computer.
- The card is full of images or data.
- A card-related error is displayed (p.523).

● Card's file formats

Cards with 128 GB or lower capacity will be formatted in FAT32.

Cards with a capacity higher than 128 GB will be formatted in exFAT. CFast cards will be formatted in exFAT regardless of capacity.

When shooting a movie with a CF card larger than 128 GB or with a CFast card formatted in exFAT, the movie will be recorded in a single file even if it exceeds 4 GB. (The movie file will exceed 4 GB.)



- If you format a card with a capacity over 128 GB with this camera and then insert it into another camera, an error may be displayed and the card may become unusable. Certain OS of a computer or card reader may not recognize a card formatted in exFAT.
- When the card is formatted or data is erased, only the file management information is changed. The actual data is not completely erased. Be aware of this when selling or discarding the card. When discarding the card, destroy the card physically to prevent personal data from being leaked.



- The card capacity displayed on the card format screen may be smaller than the capacity indicated on the card.
- This device incorporates exFAT technology licensed from Microsoft.

MENU Disabling the Beeper

You can prevent the beeper from sounding when focus is achieved.

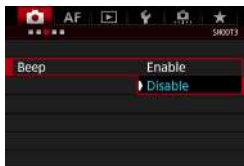

- 1 **Select [Beep].**
 - Under the [**3**] tab, select [**Beep**], then press <SET>.
- 2 **Select [Disable].**
 - ▶ The beeper will not sound.

Regardless of the [**3**: **Beep**] setting, touchscreen operation sound is disabled during Live View shooting and movie shooting. However, when focus is achieved with AF, the beeper (focus confirmation beep) will sound depending on the [**3**: **Beep**] setting.

MENU Setting the Power-off Time/Auto Power Off

To save battery power, the camera turns off automatically after a set time of idle operation elapses. The default setting is 1 min., but this setting can be changed. If you do not want the camera to turn off automatically, set this to [**Disable**]. After the power turns off, you can turn on the camera again by pressing the shutter button or other buttons.



- 1 **Select [Auto power off].**
 - Under the [**2**] tab, select [**Auto power off**], then press <SET>.
- 2 **Set the desired time.**
 - Select the desired setting, then press <SET>.

Even if [**Disable**] is set, the LCD monitor will turn off automatically after approx. 30 min. to save power. (The camera's power does not turn off.)

MENU Setting the Image Review Time

You can set how long the image is displayed on the LCD monitor immediately after shooting. To keep the image displayed, set **[Hold]**. To not have the image displayed, set **[Off]**.



1 Select **[Image review]**.

- Under the [**3**] tab, select **[Image review]**, then press <SET>.

2 Set the desired time.

- Select the desired setting, then press <SET>.



If **[Hold]** is set, the image will be displayed until the auto power off time elapses.

MENU Reverting the Camera to the Default Settings

The camera's shooting function settings and menu settings can be reverted to their defaults.

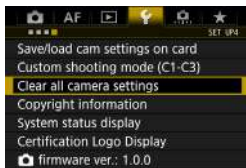

1 Select **[Clear all camera settings]**.

- Under the [**4**] tab, select **[Clear all camera settings]**, then press <SET>.





2 Select **[OK]**.

- ▶ Clearing all the camera settings will reset the camera to the default settings on pages 78-80.



For details on setting a Custom Function, see page 420.

Shooting Function Settings

Shooting mode	P (Program AE)
AF operation	One-Shot AF
AF area selection mode	Single-point AF (Manual selection)
AF point selection	Center
Registered AF point	Canceled
Metering mode	 (Evaluative metering)
ISO speed settings	
ISO speed	Automatic setting (Auto)
Range for stills	Minimum: 100 Maximum: 51200
Auto range	Minimum: 100 Maximum: 25600
Minimum shutter speed for auto	Auto
Drive mode	 (Single shooting)
Exposure compensation/AEB	Canceled
Flash exposure compensation	Canceled
Multiple exposure	Disable
Anti-flicker shooting	Disable
Mirror lockup	Disable
Viewfinder display	
Electronic level	Hide
Grid display	Hide
Show/hide in viewfinder	Only flicker detection selected
Custom Functions	Unchanged
External Speedlite control	
Flash firing	Enable
E-TTL II flash metering	Evaluative flash metering
Flash sync. speed in Av mode	Auto

AF













Case 1 - 6	Case1/Parameter settings of all cases cleared
AI Servo 1st image priority	Equal priority
AI Servo 2nd image priority	Equal priority
Lens electronic MF	Enable after One-Shot AF
AF-assist beam firing	Enable
One-Shot AF release priority	Focus priority
Auto AF pt sel.:EOS iTR AF	EOS iTR AF (Face priority)
Lens drive when AF impossible	Continue focus search
Selectable AF point	All points
Select AF area selection mode	All items selected
AF area selection method	M-Fn button
Orientation linked AF point	Same for both vertical/horizontal
Initial AF point,  AI Servo AF	Auto
AF point selection pattern	Stops at AF area edges
AF point display during focus	Selected AF point
AF point brightness	Normal
AF operation display in viewfinder	Displayed in viewfinder
AF Microadjustment	Disable/ Adjustment amount retained

Image Recording Settings

Image size	L (Large)
JPEG quality	8
Picture Style	Standard
Auto Lighting Optimizer	Standard
Lens aberration correction	
Peripheral illumination correction	Enable
Chromatic aberration correction	Enable
Distortion correction	Disable
Diffraction correction	Enable
White balance	 (Ambience priority)
Custom WB data	Registered setting retained
Personal WB	Registered setting retained
White balance shift	Canceled
White balance bracketing	Canceled
Color space	sRGB
Long exposure noise reduction	Disable
High ISO speed noise reduction	Standard
Highlight tone priority	Disable
Record function card/folder selection	
Record function	Standard
Record and playback	Unchanged
File numbering	Continuous
File name	Preset code
Dust Delete Data	Erased

Camera Settings

Auto power off	1 min.
Beeper	Enable
Release shutter without card	Enable
Image review time	2 sec.
Highlight alert	Disable
AF point display	Disable
Playback grid	Off
Histogram display	Brightness
Movie playback count	Unchanged
Magnification (Approx.)	2x (magnify from center)
Control over HDMI	Disable
Image jump w/ 	 (10 images)
Auto rotate vertical images	On  
LCD brightness	     
Date/Time/Zone	Unchanged
Video system	Unchanged
INFO button display options	All items selected
Custom Quick Control	Unchanged
Language	Unchanged
Auto cleaning	Enable
Communication settings	Unchanged
GPS	Disable
Custom shooting mode	Unchanged
Copyright information	Unchanged
System status display	Saved
Configure: MY MENU	Unchanged
Menu display	Normal display

Live View Shooting Settings

Live View shooting	Enable
AF method	+Tracking
Grid display	Hide
Exposure simulation	Enable
Silent LV shooting	Mode 1
Metering timer	8 sec.
LV touch control	Standard

Movie Shooting Settings

ISO speed settings	
ISO speed	Automatic setting (Auto)
Range for movies	Minimum: 100 Maximum: 25600
Range for	Minimum: 100 Maximum: 12800
Movie Servo AF	Enable
AF method	+Tracking
Grid display	Hide
Movie recording quality	
MOV/MP4	MOV
Movie recording size	NTSC: PAL:
24.00P	Disable
High Frame Rate	Disable
Sound recording	Auto
Wind filter	Disable
Attenuator	Disable

Movie Servo AF Speed	
When active	Always on
AF speed	0 (Standard)
Movie Servo AF track sensitivity	0
Metering timer	8 sec.
LV touch control	Standard
Time code	
Count up	Unchanged
Start time setting	Unchanged
Movie recording count	Unchanged
Movie playback count	Unchanged
HDMI	Unchanged
Drop frame	Unchanged
Silent Control	Disable
button function	AF /-
HDMI display	
HDMI frame rate	Auto

⌘ Displaying the Grid in the Viewfinder

You can display a grid in the viewfinder to help you check the camera tilt or compose the shot.

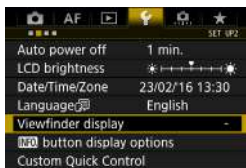

- 1 **Select [Viewfinder display].**
 - Under the [**2**] tab, select [Viewfinder display], then press <SET>.

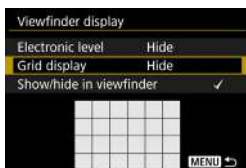

- 2 **Select [Grid display].**



- 3 **Select [Show].**
 - ▶ When you exit the menu, the grid will appear in the viewfinder.

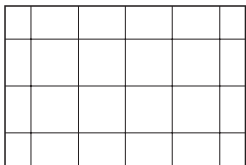

You can display a grid on the LCD monitor during Live View shooting and before you start shooting a movie (p.280, 333).

Displaying the Electronic Level

You can display the electronic level on the LCD monitor and in the viewfinder to help you correct the camera tilt.

Displaying the Electronic Level on the LCD Monitor

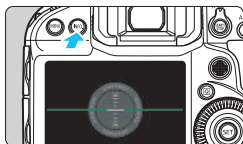

1 Press the <INFO.> button.

- Each time you press the <INFO.> button, the screen display will change.
- Display the electronic level.

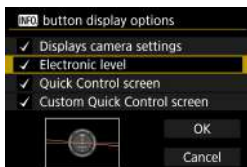

- If the electronic level does not appear, set [**F2**: **INFO. button display options**] so that the electronic level can be displayed (p.478).



Vertical level Horizontal level

2 Check the camera's tilt.

- The horizontal and vertical tilts are displayed in 1° increments.
- When the red line turns green, it indicates that the tilt is almost corrected.

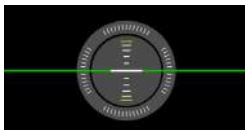

- Even when the tilt is corrected, there may be a margin of error of approx. $\pm 1^\circ$.
- If the camera is very tilted, the electronic level's margin of error will be larger.

 During Live View shooting and before movie shooting, you can also display the electronic level as described above (except with **T**+ Tracking).

MENU Displaying the Electronic Level in the Viewfinder

An electronic level can be displayed on the upper part of the viewfinder. Since this indicator is displayed during shooting, you can take the picture while checking the camera tilt.



1 Select [Viewfinder display].

- Under the [**2**] tab, select [Viewfinder display], then press <SET>.



2 Select [Electronic level].



3 Select [Show].

4 Press the shutter button halfway.

- The electronic level will be displayed on the upper part of the viewfinder.
- This level also works with vertical shooting.

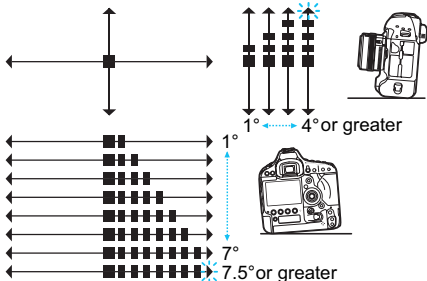

Even when the tilt is corrected, there may be a margin of error of approx. $\pm 1^\circ$.

MENU Setting the Viewfinder Information Display

The shooting function settings (Shooting mode, Metering mode, White balance, Drive mode, AF operation, Flicker detection) can be displayed in the viewfinder.

By default, only Flicker detection is checkmarked [✓].



1 Select [Viewfinder display].

- Under the [2] tab, select [Viewfinder display], then press <SET>.

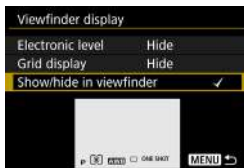

2 Select [Show/hide in viewfinder].



3 Checkmark [✓] the information to be displayed.

- Select the information to display and press <SET> to add a checkmark [✓].
- Repeat this procedure to add a checkmark [✓] to all the information to be displayed. Then select [OK].
- When you exit the menu, the checkmarked information will appear in the viewfinder (p.31).



When you press the <MODE>, <DRIVE•AF>, <WB>, or <WB> button, operate the lens's focus mode switch, or when a lens equipped with an electronic manual focusing function is used and the AF/MF switches as the lens's focusing ring is turned (p.124), the respective information will appear in the viewfinder regardless of whether it is checkmarked.

? Help

When [INFO Help] is displayed at the bottom of the menu screen, the feature's description (Help) can be displayed. The Help screen is displayed only while you hold down the <INFO.> button. If the Help fills more than one screen, a scroll bar will appear on the right edge. To scroll, hold down the <INFO.> button and turn the <DIAL> dial.

● Example: [AF1: Case 2]

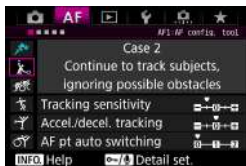

INFO.
→

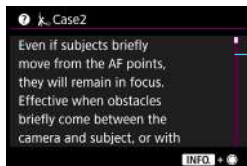

Scroll bar

● Example: [AF4: Orientation linked AF point]

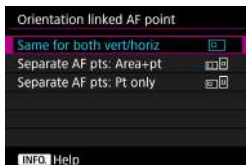

INFO.
→

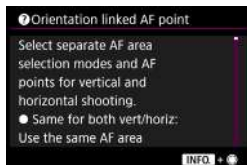

● Example: [DIAL 6: Multi function lock]



INFO.
→

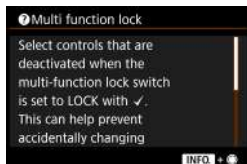



2

Setting the AF and Drive Modes

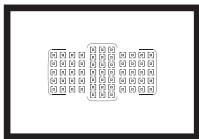

The AF points in the viewfinder are arranged to make AF shooting suitable for a wide variety of subjects and scenes.

You can also select the AF operation and drive mode that best match the shooting conditions and subject.



<AF> stands for autofocus. <MF> stands for manual focus.

AF: Selecting the AF Operation

You can select the AF operation characteristics to suit the shooting conditions or subject.

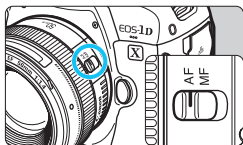

- 1 Set the lens's focus mode switch to **<AF>**.

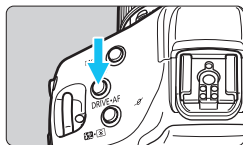

- 2 Press the **<DRIVE/AF>** button ().

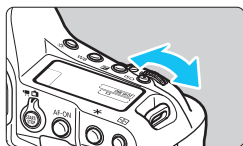

- 3 Select the **AF operation**.

- While looking at the top LCD panel or in the viewfinder, turn the  dial.
ONE SHOT : One-Shot AF
AI SERVO : AI Servo AF



- When the AF area selection mode (p.96) is set to Automatic selection AF, Large Zone AF, or Zone AF, AF is possible while using the face detection and subject's color information (p.127).
- AF is also possible by pressing the **<AF-ON>** button.

One-Shot AF for Still Subjects

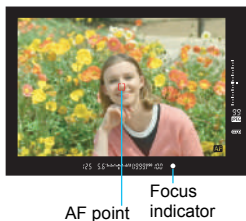

Suited for still subjects. When you press the shutter button halfway, the camera will focus only once.

- The AF point which achieves focus flashes in red, and the focus indicator <●> in the viewfinder will also light up.
- With evaluative metering (p.238), the exposure setting will be set at the same time as focus is achieved.
- While you hold down the shutter button halfway, the focus will be locked. You can then recompose the shot if desired.



- If focus cannot be achieved, the focus indicator <●> in the viewfinder will blink. If this occurs, the picture cannot be taken even if the shutter button is pressed completely. Recompose the shot and try to focus again or see “When Autofocus Fails” (p.144).
- If [CAMERA 3: Beep] is set to [Disable], the beeper will not sound when focus is achieved.
- After achieving focus with One-Shot AF, you can lock the focus on a subject and recompose the shot. This is called “focus lock”. This is useful when you want to focus on a peripheral subject not covered by the Area AF frame.
- When a lens equipped with electronic manual focusing function is used, after achieving focus, you can focus manually by turning the lens focusing ring while pressing the shutter button halfway.

AI Servo AF for Moving Subjects



This AF operation is suited for moving subjects when the focusing distance keeps changing. While you hold down the shutter button halfway, the camera will keep focusing on the subject continuously.

- The exposure is set at the moment the picture is taken.
- When the AF area selection mode (p.96) is set to Automatic selection AF, focus tracking will continue as long as the Area AF frame covers the subject.

 With AI Servo AF, the beeper will not sound even when focus is achieved. Also, the focus indicator <●> in the viewfinder will not light up.

AF Operation Indicator



When you press the shutter button halfway and the camera is focusing with AF, the <AF> icon will appear on the lower right of the viewfinder. In One-Shot AF mode, the icon also appears if you press the shutter button halfway after focus is achieved.

 The AF operation indicator can be displayed outside the viewfinder's image area (p.137).

Selecting the AF Area and AF Point

The camera has 61 AF points for autofocus. You can select the AF area selection mode and AF point(s) suiting the scene or subject.

 Depending on the lens attached to the camera, the number of usable AF points, AF point patterns, Area AF frame, etc. will differ. For details, see “Lenses and Usable AF Points” on page 102.

AF Area Selection Mode

You can select one of seven AF area selection modes. For the selection procedure, see page 93.

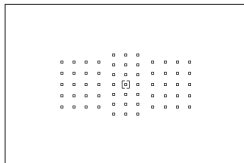

Single-point Spot AF (Manual selection)

For pinpoint focusing.

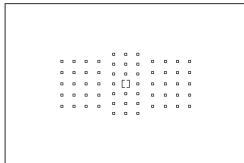

Single-point AF (Manual selection)

Select one AF point to focus.

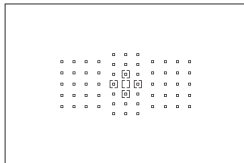

AF point expansion (Manual selection)

The manually-selected AF point <[]> and four adjacent AF points <◻> (above, below, on the left, and on the right) are used to focus.

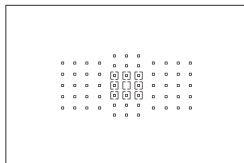

 **AF point expansion (Manual selection, surrounding points)**

The manually-selected AF point <[]> and the surrounding AF points <□> are used to focus.

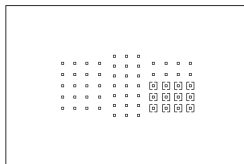

 **Zone AF (Manual selection of zone)**

One of nine focusing zones is used to focus.

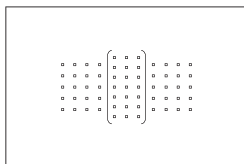

 **Large Zone AF (Manual Zone Selection)**

One of three focusing zones (left, center, and right) is used to focus.

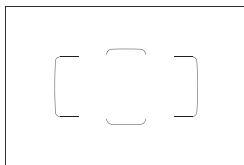

 **Automatic selection AF**

The Area AF frame (entire AF area) is used to focus.

Selecting the AF Area Selection Mode

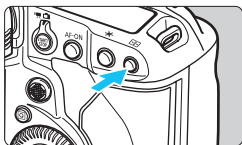

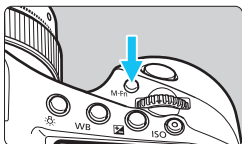

1 Press the  button (ⓘ6).



2 Press the **<M-Fn> button.**

- Look through the viewfinder and press the **<M-Fn> button.**
- Each time you press the **<M-Fn> button**, the AF area selection mode changes.



- With [**AF4: Select AF area selec. mode**], you can limit the selectable AF area selection modes to only those you want to use (p.131).
- If you set [**AF4: AF area selection method**] to [ → **Main Dial**], you can select the AF area selection mode by pressing the , then turning the  dial (p.132).

Selecting the AF Point Manually

You can manually select the AF point or zone.

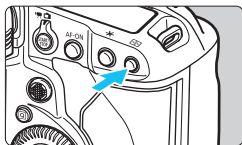





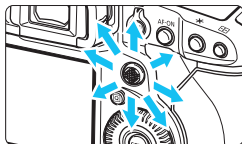

1 Press the button ()



- ▶ The AF points will be displayed in the viewfinder.
- In AF point expansion modes, adjacent AF points will also be displayed.
- In the Zone AF or Large Zone AF mode, the selected zone will be displayed.

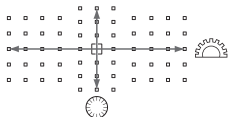

2 Select an AF point.

- The AF point selection will change in the direction you tilt . If you press  straight down, the center AF point (or center zone) will be selected.
- You can also select a horizontal AF point by turning the  dial and select a vertical AF point by turning the  dial.
- In the Zone AF and Large Zone AF modes, turning the  or  dial will change the zone (in a looping sequence for Zone AF).



 • When [AF4: Initial AF pt,  AI Servo AF] is set to [Initial  AF pt selected] (p.134), you can use this method to manually select the AI Servo AF's initial position.

- When you press the  button, the top LCD panel displays the following:
 - Zone AF, Large Zone AF, Automatic selection AF: [] AF
 - Spot AF, 1 pt AF, Expand AF Area: SEL [] (Center), SEL AF (Off center)

AF Point Display Indications

Pressing the <  > button lights up the AF points that are cross-type AF points for high-precision autofocusing. The blinking AF points are horizontal-line or vertical-line sensitive. For details, see pages 100-108.

Registering the AF point

You can register a frequently-used AF point to the camera.

When you use the button set with the [ **6: Custom Controls**] (p.443) menu's detailed settings screens for [**Metering and AF start**], [**Switch to registered AF point**], [**Direct AF point selection**], or [**Register/recall shooting func**], you can instantly switch from the current AF point to the registered AF point.

For details on registering the AF point, see page 448.

AF Area Selection Modes

☐ Single-point Spot AF (Manual selection)

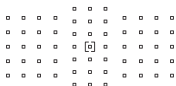

For pinpoint focusing over a narrower area than with single-point AF. Select one AF point <☐> to focus.

Effective for pinpoint focusing or focusing on overlapping subjects such as an animal in a cage. Since Single-point Spot AF covers a very small area, focusing may be difficult during hand-held shooting or for a moving subject.

☐ Single-point AF (Manual selection)



Select one AF point <☐> to be used for focusing.

☐☐☐ AF point expansion (Manual selection ☐☐☐)

The manually-selected AF point <☐> and adjacent AF points <☐☐> (above, below, on the left, and on the right) are used to focus. Effective when it is difficult to track a moving subject with just one AF point.

With AI Servo AF, the initial manually-selected AF point <☐> must focus-track the subject first. However, it is superior to Zone AF in focusing on the target subject.

With One-Shot AF, when focus is achieved with expanded AF points, the expanded AF points <☐☐☐> will also be displayed along with the manually-selected AF point <☐>.



AF point expansion (Manual selection, surrounding points)

The manually-selected AF point <[]> and surrounding AF points <◁▷> are used to focus. Focusing is performed over a wider area than with AF point expansion (manual selection ◻◻◻). Effective when it is difficult to track a moving subject with just one AF point. AI Servo AF and One-Shot AF work in the same way as with AF point expansion (manual selection ◻◻◻) mode (p.96).



Zone AF (Manual selection of zone)

The AF area is divided into nine focusing zones for focusing. All the AF points in the selected zone are used for the automatic AF point selection. It is superior to single-point AF or AF point expansion in achieving focus, and it is effective for moving subjects. However, since it is inclined to focus on the nearest subject, focusing on a specific target may be more difficult. The AF point(s) achieving focus is displayed as <[]>.

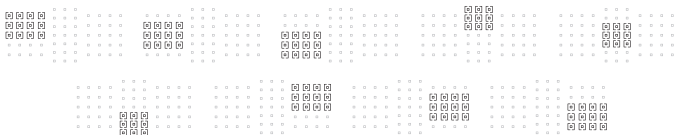

[] Large Zone AF (Manual Zone Selection)

The AF area is divided into three focusing zones (left, center, and right) for focusing. Since the focusing area is larger than with Zone AF and all the AF points in the selected zone are used for the automatic AF point selection, it is superior to single-point AF and AF point expansion in tracking the subject, and it is effective for moving subjects.

However, since it is inclined to focus on the nearest subject, focusing on a specific target is may be more difficult.

The AF point(s) achieving focus is displayed as <[]>.



[] Automatic selection AF

The Area AF frame (entire AF area) is used to focus. The AF point(s) achieving focus is displayed as <[]>.



With One-Shot AF, pressing the shutter button halfway will display the AF point(s) <[]> that achieved focus. If multiple AF points are displayed, it means they all have achieved focus. This mode tends to focus on the nearest subject.

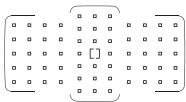

With AI Servo AF, you can set the AI Servo AF's initial position with [AF4: Initial AF pt, [] AI Servo AF] (p.134). As long as the Area AF frame can track the subject during shooting, focusing will continue.



- When AI Servo AF mode is set for Automatic selection AF, Large Zone AF, or Zone AF, the active AF point <[]> will keep switching to track the subject. However, under certain shooting conditions (such as when the subject is small), it may not be able to track the subject.
- With Single-point Spot AF, focusing with an EOS-dedicated, external Speedlite's AF-assist beam may be difficult.
- If a peripheral AF point or a wide-angle or telephoto lens is used, achieving focus may be difficult with an EOS-dedicated, external Speedlite's AF-assist beam. In such a case, use the center AF point or an AF point close to the center.
- In low temperatures, it may be difficult to see the Area AF frame and Large Zone AF frame.
- It may be difficult to see the AF points when looking through the viewfinder while wearing polarized sunglasses or similar equipment.



- With [**AF4: Orientation linked AF point**], you can set the AF area selection mode + AF point or only the AF point separately for the horizontal and vertical orientations (p.132).
- With [**AF4: Selectable AF point**], you can change the number of manually selectable AF points (p.130).

AF Sensor

The camera's AF sensor has 61 AF points. The illustration below shows the AF sensor pattern corresponding to each AF point. When using lenses with a maximum aperture of $f/2.8$ or faster, high-precision AF is possible at the viewfinder center.

Depending on the lens attached to the camera, the number of usable AF points, AF point patterns, the shape of Area AF frame, etc. vary. For details, see "Lenses and Usable AF Points" on page 102.

Diagram

Cross-type focusing:

$f/4$ horizontal + $f/5.6$ or $f/8$ vertical

Cross-type focusing:

$f/5.6$ or $f/8$ vertical + $f/5.6$ or $f/8$ horizontal

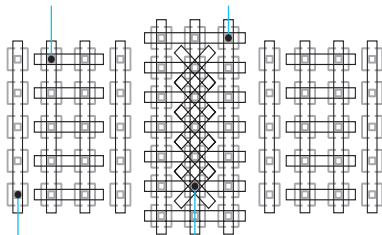



$f/5.6$ or $f/8$ vertical focusing

Dual cross-type focusing:



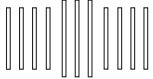

$f/2.8$ right diagonal + $f/2.8$ left diagonal

$f/5.6$ or $f/8$ vertical + $f/5.6$ or $f/8$ horizontal

	<p>These focusing sensors are geared to obtain higher precision focusing for lenses with a maximum aperture of $f/2.8$ or faster. A diagonal cross pattern makes it easier to focus subjects that may be difficult to focus. They cover the five AF points vertically aligned at the center.</p>
	<p>These focusing sensors are geared to obtain high-precision focusing for lenses with a maximum aperture of $f/4$ or faster. Since they have a horizontal pattern, they can detect vertical lines.</p>
	<p>These focusing sensors are geared for lenses with a maximum aperture of $f/5.6$ or faster (greater than $f/5.6$ but not exceeding $f/8$ with an Extender attached). Since they have a horizontal pattern, they can detect vertical lines. They cover the three columns of AF points at the viewfinder center.</p>
	<p>These focusing sensors are geared for lenses with a maximum aperture of $f/5.6$ or faster (greater than $f/5.6$ but not exceeding $f/8$ with an Extender attached). Since they have a vertical pattern, they can detect horizontal lines. They cover all 61 AF points.</p>

Lenses and Usable AF Points



- Although the camera has 61 AF points, the number of usable AF points, focusing patterns, and Area AF frame configuration vary depending on the lens. The lenses are thereby classified into eleven groups from A to K.
- When using a lens in groups G to K, fewer AF points will be usable.
- See which group each lens belongs to on pages 109-112. Check which group the lens in use belongs to.

- When you press the  button, the AF points indicated by the  mark will blink. (The // AF points will stay lit.) Regarding lighting up or blinking of the AF points, see page 95.
- Regarding new lenses marketed after the EOS-1D X Mark II (in the first half of 2016), check the Canon website to see which group they belong to.
- Some lenses may not be available in certain countries or regions.

Group A

Autofocusing with 61 points is possible. All the AF area selection modes are selectable.



- : Dual cross-type AF point. Subject tracking is superior and the focusing precision is higher than with other AF points.
- : Cross-type AF point. Subject tracking is superior and high-precision focusing is achieved.
- : AF points sensitive to horizontal lines.

Group B

Autofocusing with 61 points is possible. All the AF area selection modes are selectable.

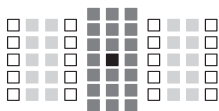

- : Dual cross-type AF point. Subject tracking is superior and the focusing precision is higher than with other AF points.
- : Cross-type AF point. Subject tracking is superior and high-precision focusing is achieved.
- : AF points sensitive to horizontal lines.

Group C

Autofocusing with 61 points is possible. All the AF area selection modes are selectable.

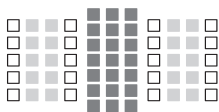

- : Cross-type AF point. Subject tracking is superior and high-precision focusing is achieved.
- : AF points sensitive to horizontal lines.

Group D

Autofocusing with 61 points is possible. All the AF area selection modes are selectable.

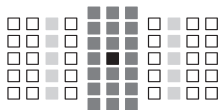

- : Dual cross-type AF point. Subject tracking is superior and the focusing precision is higher than with other AF points.
- : Cross-type AF point. Subject tracking is superior and high-precision focusing is achieved.
- : AF points sensitive to horizontal lines.

Group E

Autofocusing with 61 points is possible. All the AF area selection modes are selectable.

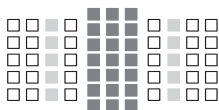

- : Cross-type AF point. Subject tracking is superior and high-precision focusing is achieved.
- : tracking is superior and high-precision focusing is achieved.
- : AF points sensitive to horizontal lines.

Group F

Autofocusing with 61 points is possible. All the AF area selection modes are selectable.

If an Extender is attached (Extender compatible lenses only) and the maximum aperture is $f/8$ (greater than $f/5.6$ but not exceeding $f/8$), AF will be possible.

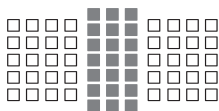

- : Cross-type AF point. Subject tracking is superior and high-precision focusing is achieved.
- : tracking is superior and high-precision focusing is achieved.
- : AF points sensitive to horizontal lines.

- If the maximum aperture is slower than $f/5.6$ (greater than $f/5.6$ but not exceeding $f/8$), focus may not be achieved with AF when shooting low-contrast or low-light subjects.
- If the maximum aperture is slower than $f/8$ (exceeding $f/8$), AF is not possible during viewfinder shooting.

Group G

Autofocusing with only the 47 points shown in the diagram is possible. (Not possible with all 61 AF points.) All the AF area selection modes are selectable. During automatic AF point selection, the outer frame marking the AF area (Area AF frame) will be different from 61-point Automatic selection AF.

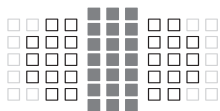

- : Cross-type AF point. Subject tracking is superior and high-precision focusing is achieved.
- : AF points sensitive to horizontal lines.
- : Disabled AF points (not displayed).

Group H

Autofocusing with only the 33 points shown in the diagram is possible. (Not possible with all 61 AF points.) All the AF area selection modes are selectable. During automatic AF point selection, the outer frame marking the AF area (Area AF frame) will be different from 61-point Automatic selection AF.



- : Cross-type AF point. Subject tracking is superior and high-precision focusing is achieved.
- : AF points sensitive to horizontal lines.
- : Disabled AF points (not displayed).

Group I

Autofocusing with only the 13 points shown in the diagram is possible. Only the following AF area selection modes are selectable: Single-point Spot AF, Single-point AF, AF point expansion (manual selection^①), Zone AF (Manual selection of zone), and 13-point automatic selection AF.

If an Extender is attached (Extender compatible lenses only) and the maximum aperture is $f/8$ (greater than $f/5.6$ but not exceeding $f/8$), AF will be possible.



- : Cross-type AF point. Subject tracking is superior and high-precision focusing is achieved.
- : AF points sensitive to horizontal lines (AF points in line extending left and right through center AF point) or vertical lines (top and bottom AF points adjacent to the center AF point).
- : Disabled AF points (not displayed).

- Even when AF point expansion (manual selection^①) is set, AF point expansion will be applied to the 13 AF points. If the manually selected AF point does not have all four AF points on the top, bottom, left, or right, it will expand only to those active AF points that are adjacent to it.
- If the maximum aperture is slower than $f/5.6$ (greater than $f/5.6$ but not exceeding $f/8$), focus may not be achieved with AF when shooting low-contrast or low-light subjects.
- If the maximum aperture is slower than $f/8$ (exceeding $f/8$), AF is not possible during viewfinder shooting.

Group J

Autofocusing with only the 9 points shown in the diagram is possible. Only the following AF area selection modes are selectable: Single-point Spot AF, Single-point AF, AF point expansion (manual selection ) , and 9-point automatic selection AF.

If an Extender is attached (Extender compatible lenses only) and the maximum aperture is $f/8$ (greater than $f/5.6$ but not exceeding $f/8$), AF will be possible.



- : Cross-type AF point. Subject tracking is superior and high-precision focusing is achieved.
- : AF points sensitive to horizontal lines (AF points in line extending left and right through center AF point) or vertical lines (top and bottom AF points adjacent to the center AF point).
- : Disabled AF points (not displayed).

- Even when AF point expansion (manual selection ) is set, AF point expansion will be applied to the 9 AF points. If the manually selected AF point does not have all four AF points on the top, bottom, left, or right, it will expand only to those active AF points that are adjacent to it.
- If the maximum aperture is slower than $f/5.6$ (greater than $f/5.6$ but not exceeding $f/8$), focus may not be achieved with AF when shooting low-contrast or low-light subjects.
- If the maximum aperture is slower than $f/8$ (exceeding $f/8$), AF is not possible during viewfinder shooting.

Group K

AF is possible with the center AF point and the adjacent AF points above, below, on the left, and on the right. Only the following AF area selection modes are selectable: Single-point Spot AF, Single-point AF, and AF point expansion (manual selection^④).



- : Cross-type AF point. Subject tracking is superior and high-precision focusing is achieved.
- : AF points sensitive to horizontal lines (left and right AF points adjacent to the center AF point) or vertical lines (top and bottom AF points adjacent to the center AF point). Not manually selectable. It works only when AF point expansion (manual selection^④) is selected.
- : Disabled AF points (not displayed).

Lens Group Designations (As of January 2016)

EF14mm f/2.8L USM	B	EF180mm f/3.5L Macro USM	
EF14mm f/2.8L II USM	B	+ Extender EF1.4x I/II/III	H
EF15mm f/2.8 Fisheye	B	EF200mm f/1.8L USM	A
EF20mm f/2.8 USM	B	EF200mm f/1.8L USM	
EF24mm f/1.4L USM	A	+ Extender EF1.4x I/II/III	A*
EF24mm f/1.4L II USM	A	EF200mm f/1.8L USM	
EF24mm f/2.8	B	+ Extender EF2x I/II/III	C*
EF24mm f/2.8 IS USM	B	EF200mm f/2L IS USM	A
EF28mm f/1.8 USM	A	EF200mm f/2L IS USM	
EF28mm f/2.8	D	+ Extender EF1.4x I/II/III	A
EF28mm f/2.8 IS USM	B	EF200mm f/2L IS USM	
EF35mm f/1.4L USM	A	+ Extender EF2x I/II/III	C
EF35mm f/1.4L II USM	A	EF200mm f/2.8L USM	A
EF35mm f/2	A	EF200mm f/2.8L USM	
EF35mm f/2 IS USM	A	+ Extender EF1.4x I/II/III	C
EF40mm f/2.8 STM	D	EF200mm f/2.8L USM	
EF50mm f/1.0L USM	A	+ Extender EF2x I/II/III	F
EF50mm f/1.2L USM	A	EF200mm f/2.8L II USM	A
EF50mm f/1.4 USM	A	+ Extender EF1.4x I/II/III	C
EF50mm f/1.8	A	EF200mm f/2.8L II USM	
EF50mm f/1.8 II	A	+ Extender EF2x I/II/III	F
EF50mm f/1.8 STM	A	EF300mm f/2.8L USM	A
EF50mm f/2.5 Compact Macro	C	EF300mm f/2.8L USM	
EF50mm f/2.5 Compact Macro		+ Extender EF1.4x I/II/III	C*
+ LIFE SIZE Converter	F	EF300mm f/2.8L USM	
EF85mm f/1.2L USM	A	+ Extender EF2x I/II/III	F*
EF85mm f/1.2L II USM	A	EF300mm f/2.8L IS USM	A
EF85mm f/1.8 USM	A	EF300mm f/2.8L IS USM	
EF100mm f/2 USM	A	+ Extender EF1.4x I/II/III	C
EF100mm f/2.8 Macro	C	EF300mm f/2.8L IS USM	
EF100mm f/2.8 Macro USM	F	+ Extender EF2x I/II/III	F
EF100mm f/2.8L Macro IS USM	C	EF300mm f/2.8L IS II USM	A
EF135mm f/2L USM	A	EF300mm f/2.8L IS II USM	
EF135mm f/2L USM		+ Extender EF1.4x I/II/III	C
+ Extender EF1.4x I/II/III	A	EF300mm f/2.8L IS II USM	
EF135mm f/2L USM		+ Extender EF2x I/II/III	F
+ Extender EF2x I/II/III	C	EF300mm f/4L USM	C
EF135mm f/2.8 (Softfocus)	A	EF300mm f/4L USM	
EF180mm f/3.5L Macro USM	H	+ Extender EF1.4x I/II/III	F
		EF300mm f/4L USM	
		+ Extender EF2x I/II	J (f/8)

Lenses and Usable AF Points

EF300mm f/4L USM + Extender EF2x III	I (f/8)	EF400mm f/5.6L USM + Extender EF1.4x III	F (f/8)
EF300mm f/4L IS USM	C	EF500mm f/4L IS USM	C
EF300mm f/4L IS USM + Extender EF1.4x I/II/III	F	EF500mm f/4L IS USM + Extender EF1.4x I/II/III	F
EF300mm f/4L IS USM + Extender EF2x I/II	J (f/8)	EF500mm f/4L IS USM + Extender EF2x I/II	J (f/8)
EF300mm f/4L IS USM + Extender EF2x III	I (f/8)	EF500mm f/4L IS USM + Extender EF2x III	F (f/8)
EF400mm f/2.8L USM	A	EF500mm f/4L IS II USM	C
EF400mm f/2.8L USM + Extender EF1.4x I/II/III	C*	EF500mm f/4L IS II USM + Extender EF1.4x I/II/III	F
EF400mm f/2.8L USM + Extender EF2x I/II/III	F*	EF500mm f/4L IS II USM + Extender EF2x I/II	J (f/8)
EF400mm f/2.8L II USM	A	EF500mm f/4L IS II USM + Extender EF2x III	F (f/8)
EF400mm f/2.8L II USM + Extender EF1.4x I/II/III	C*	EF500mm f/4.5L USM	F
EF400mm f/2.8L II USM + Extender EF2x I/II/III	F*	EF500mm f/4.5L USM + Extender EF1.4x I/II	J (f/8)
EF400mm f/2.8L IS USM	A	EF500mm f/4.5L USM + Extender EF1.4x III	F (f/8)*
EF400mm f/2.8L IS USM + Extender EF1.4x I/II/III	C	EF600mm f/4L USM	C
EF400mm f/2.8L IS USM + Extender EF2x I/II/III	F	EF600mm f/4L USM + Extender EF1.4x I/II/III	F*
EF400mm f/2.8L IS II USM	A	EF600mm f/4L USM + Extender EF2x I/II	J (f/8)
EF400mm f/2.8L IS II USM + Extender EF1.4x I/II/III	C	EF600mm f/4L USM + Extender EF2x III	F (f/8)*
EF400mm f/2.8L IS II USM + Extender EF2x I/II/III	F	EF600mm f/4L IS USM	C
EF400mm f/4 DO IS USM	C	EF600mm f/4L IS USM + Extender EF1.4x I/II/III	F
EF400mm f/4 DO IS USM + Extender EF1.4x I/II/III	F	EF600mm f/4L IS USM + Extender EF2x I/II	J (f/8)
EF400mm f/4 DO IS USM + Extender EF2x I/II	J (f/8)	EF600mm f/4L IS USM + Extender EF2x III	F (f/8)
EF400mm f/4 DO IS USM + Extender EF2x III	F (f/8)	EF600mm f/4L IS II USM	C
EF400mm f/4 DO IS II USM	C	EF600mm f/4L IS II USM + Extender EF1.4x I/II/III	F
EF400mm f/4 DO IS II USM + Extender EF1.4x I/II/III	F	EF600mm f/4L IS II USM + Extender EF2x I/II	J (f/8)
EF400mm f/4 DO IS II USM + Extender EF2x I/II	J (f/8)	EF600mm f/4L IS II USM + Extender EF2x III	F (f/8)
EF400mm f/4 DO IS II USM + Extender EF2x III	F (f/8)	EF800mm f/5.6L IS USM	G
EF400mm f/5.6L USM	F	EF800mm f/5.6L IS USM + Extender EF1.4x I/II/III	J (f/8)
EF400mm f/5.6L USM + Extender EF1.4x I/II	J (f/8)	EF1200mm f/5.6L USM	H

EF1200mm f/5.6L USM + Extender EF1.4x I/II/III	J (f/8)*	EF35-70mm f/3.5-4.5	G
EF8-15mm f/4L Fisheye USM	C	EF35-70mm f/3.5-4.5A	G
EF11-24mm f/4L USM	E	EF35-80mm f/4-5.6	G
EF16-35mm f/2.8L USM	A	EF35-80mm f/4-5.6 PZ	G
EF16-35mm f/2.8L II USM	A	EF35-80mm f/4-5.6 USM	G
EF16-35mm f/4L IS USM	C	EF35-80mm f/4-5.6 II	G
EF17-35mm f/2.8L USM	A	EF35-80mm f/4-5.6 III	G
EF17-40mm f/4L USM	C	EF35-105mm f/3.5-4.5	F
EF20-35mm f/2.8L	A	EF35-105mm f/4.5-5.6	K
EF20-35mm f/3.5-4.5 USM	F	EF35-105mm f/4.5-5.6 USM	K
EF22-55mm f/4-5.6 USM	G	EF35-135mm f/3.5-4.5	F
EF24-70mm f/2.8L USM	B	EF35-135mm f/4-5.6 USM	F
EF24-70mm f/2.8L II USM	A	EF35-350mm f/3.5-5.6L USM	G
EF24-70mm f/4L IS USM	C	EF38-76mm f/4.5-5.6	F
EF24-85mm f/3.5-4.5 USM	F	EF50-200mm f/3.5-4.5	F
EF24-105mm f/3.5-5.6 IS STM	F	EF50-200mm f/3.5-4.5L	F
EF24-105mm f/4L IS USM	C	EF55-200mm f/4.5-5.6 USM	F
EF28-70mm f/2.8L USM	A	EF55-200mm f/4.5-5.6 II USM	F
EF28-70mm f/3.5-4.5	G	EF70-200mm f/2.8L USM	A
EF28-70mm f/3.5-4.5 II	G	EF70-200mm f/2.8L USM + Extender EF1.4x I/II/III	C**
EF28-80mm f/2.8-4L USM	C	EF70-200mm f/2.8L USM + Extender EF2x I/II/III	F**
EF28-80mm f/3.5-5.6	G	EF70-200mm f/2.8L IS USM	A
EF28-80mm f/3.5-5.6 USM	G	EF70-200mm f/2.8L IS USM + Extender EF1.4x I/II/III	C
EF28-80mm f/3.5-5.6 II USM	G	EF70-200mm f/2.8L IS USM + Extender EF2x I/II/III	F
EF28-80mm f/3.5-5.6 III USM	G	EF70-200mm f/2.8L IS II USM	A
EF28-80mm f/3.5-5.6 IV USM	G	EF70-200mm f/2.8L IS II USM + Extender EF1.4x I/II/III	C
EF28-80mm f/3.5-5.6 V USM	G	EF70-200mm f/2.8L IS II USM + Extender EF2x I/II/III	F
EF28-90mm f/4-5.6	F	EF70-200mm f/4L USM	C
EF28-90mm f/4-5.6 USM	F	EF70-200mm f/4L USM + Extender EF1.4x I/II/III	F
EF28-90mm f/4-5.6 II	F	EF70-200mm f/4L USM + Extender EF2x I/II/III	J (f/8)
EF28-90mm f/4-5.6 II USM	F	EF70-200mm f/4L USM + Extender EF2x III	I (f/8)
EF28-90mm f/4-5.6 III	F	EF70-200mm f/4L IS USM	C
EF28-105mm f/3.5-4.5 USM	F	EF70-200mm f/4L IS USM + Extender EF1.4x I/II/III	F
EF28-105mm f/3.5-4.5 II USM	F		
EF28-105mm f/4-5.6	G		
EF28-105mm f/4-5.6 USM	G		
EF28-135mm f/3.5-5.6 IS USM	F		
EF28-200mm f/3.5-5.6	F		
EF28-200mm f/3.5-5.6 USM	F		
EF28-300mm f/3.5-5.6L IS USM	F		

EF70-200mm f/4L IS USM + Extender EF2x I/II	J (f/8)	EF100-400mm f/4.5-5.6L IS USM + Extender EF1.4x I/II	J (f/8)
EF70-200mm f/4L IS USM + Extender EF2x III	I (f/8)	EF100-400mm f/4.5-5.6L IS USM + Extender EF1.4x III	F (f/8)
EF70-210mm f/3.5-4.5 USM	F	EF100-400mm f/4.5-5.6L IS II USM	F
EF70-210mm f/4	C	EF100-400mm f/4.5-5.6L IS II USM + Extender EF1.4x I/II	J (f/8)
EF70-300mm f/4-5.6 IS USM	F	EF100-400mm f/4.5-5.6L IS II USM + Extender EF1.4x III	F (f/8)
EF70-300mm f/4-5.6L IS USM	F	EF200-400mm f/4L IS USM Extender 1.4x	E
EF70-300mm f/4-5.6 DO IS USM	F	EF200-400mm f/4L IS USM Extender 1.4x: Built-in Ext. 1.4x used	F
EF75-300mm f/4-5.6	F	EF200-400mm f/4L IS USM Extender 1.4x + Extender EF1.4x I/II/III	F
EF75-300mm f/4-5.6 USM	F	EF200-400mm f/4L IS USM Extender 1.4x: Built-in Ext. 1.4x used + Extender EF1.4x I/II	J (f/8)
EF75-300mm f/4-5.6 II	F	EF200-400mm f/4L IS USM Extender 1.4x + Extender EF2x I/II	J (f/8)
EF75-300mm f/4-5.6 II USM	F	EF200-400mm f/4L IS USM Extender 1.4x + Extender EF2x III	F (f/8)
EF75-300mm f/4-5.6 III	F	TS-E17mm f/4L	C
EF75-300mm f/4-5.6 III USM	F	TS-E24mm f/3.5L	C
EF75-300mm f/4-5.6 IS USM	F	TS-E24mm f/3.5L II	C
EF80-200mm f/2.8L	A	TS-E45mm f/2.8	A
EF80-200mm f/4.5-5.6	F	TS-E90mm f/2.8	A
EF80-200mm f/4.5-5.6 USM	G		
EF80-200mm f/4.5-5.6 II	G		
EF90-300mm f/4.5-5.6	F		
EF90-300mm f/4.5-5.6 USM	F		
EF100-200mm f/4.5A	F		
EF100-300mm f/4.5-5.6 USM	F		
EF100-300mm f/5.6	F		
EF100-300mm f/5.6L	F		
EF100-400mm f/4.5-5.6L IS USM	F		

- If Extender EF2x (I/II/III) is attached to the EF180mm f/3.5L Macro USM lens, AF is not possible.
- When using a lens and Extender EF1.4x III/EF2x III in a combination marked with an asterisk (*) or a lens and extender in a combination marked with two asterisks (**), precise focus may not be achieved with AF. In such a case, refer to the Instruction Manual of the lens or extender used.

 If you use a TS-E lens, manual focusing will be required. The lens group designation of TS-E lenses applies only when you do not use tilt or shift function.

MENU Selecting AI Servo AF Characteristics

You can easily fine-tune AI Servo AF to suit a particular subject or shooting scene just by selecting an option from case 1 to case 6. This feature is called the “AF Configuration Tool”.

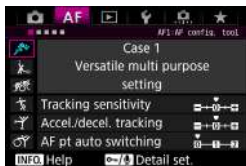

1 Select the [AF1] tab.

2 Select a case.

- Turn the <☉> dial to select a case icon, then press <SET>.
- ▶ The selected case will be set. The selected case is indicated in blue.

Case 1 to 6

As explained on pages 118 to 120, case 1 to 6 are six setting combinations of “Tracking sensitivity”, “Acceleration/deceleration tracking”, and “AF point auto switching”. Refer to the table below to select the case applicable to the subject or shooting scene.

Case	Icon	Description	Applicable Subjects	Page
Case 1		Versatile multi purpose setting	For any moving subject.	114
Case 2		Continue to track subjects, ignoring possible obstacles	Tennis players, butterfly swimmers, freestyle skiers, etc.	114
Case 3		Instantly focus on subjects suddenly entering AF points	Starting line of a bicycle race, alpine downhill skiers, etc.	115
Case 4		For subjects that accelerate or decelerate quickly	Soccer, motor sports, basketball, etc.	115
Case 5		For erratic subjects moving quickly in any direction	Figure skaters, etc.	116
Case 6		For subjects that change speed and move erratically	Rhythm gymnastics, etc.	117

Case 1: Versatile multi purpose setting



Standard setting suited for any moving subject. Works with various subjects and scenes.

Select [Case 2] to [Case 6] for the following: When an obstacle cuts across the AF points or the subject tends to stray from the AF points, when you want to focus on a subject appearing suddenly, when the speed of a moving subject changes suddenly, or when the subject dramatically moves horizontally or vertically.

Default settings

- Tracking sensitivity: 0
- Accel./decel. tracking: 0
- AF pt auto switching: 0

Case 2: Continue to track subjects, ignoring possible obstacles

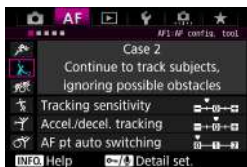

The camera will try to continue focusing on the subject even if an obstacle cuts across the AF points or if the subject strays from the AF points. Effective when there may be an obstacle blocking the subject or when you do not want to focus on the background.

Default settings

- Tracking sensitivity: Locked on: -1
- Accel./decel. tracking: 0
- AF pt auto switching: 0

If an obstacle gets in the way or if the subject moves away from the AF points for a prolonged period and the default setting is unable to track the target subject, setting [Tracking sensitivity] to [-2] may give better results (p.118).

Case 3: Instantly focus on subjects suddenly entering AF points

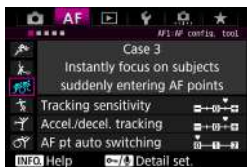

Once an AF point starts tracking the subject, this setting enables the camera to consecutively focus on subjects at different distances. If a new subject appears in front of the target subject, the camera will start focusing on the new subject. Also effective when you want to always focus on the closest subject.

Default settings

- Tracking sensitivity:
Responsive: +1
- Accel./decel. tracking: +1
- AF pt auto switching: 0



If you want to quickly focus on a subject appearing suddenly, setting [**Tracking sensitivity**] to [+2] may give better results (p.118).

Case 4: For subjects that accelerate or decelerate quickly

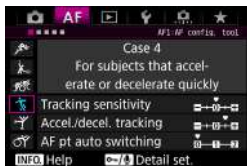

Geared for tracking moving subjects whose speed can change dramatically and suddenly.

Effective for subjects having sudden movements, sudden acceleration, sudden deceleration, or sudden stops.

Default settings

- Tracking sensitivity: 0
- Accel./decel. tracking: +1
- AF pt auto switching: 0



If the subject is in motion, and prone to sudden, dramatic changes in speed, setting [**Accel./decel. tracking**] to [+2] may give better results (p.119).

Case 5: For erratic subjects moving quickly in any direction

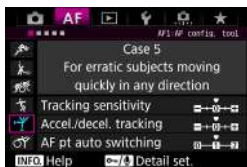

Default settings

- Tracking sensitivity: 0
- Accel./decel. tracking: 0
- AF pt auto switching: +1

Even if the target subject moves dramatically up, down, left, or right, the AF point will switch automatically to focus-track the subject. Effective for shooting subjects that move dramatically up, down, left, or right.

It is recommended to use this setting with the following modes; AF point expansion (manual selection \square), AF point expansion (manual selection, surrounding points), Zone AF, Large Zone AF, and Automatic selection AF. With Single-point Spot AF or Single-point AF mode, the tracking action will be the same as with Case 1.

 If the subject moves even more dramatically up, down, left, or right, setting **[AF pt auto switching]** to **[+2]** may give better results (p.120).

Case 6: For subjects that change speed and move erratically

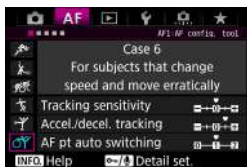

Default settings

- Tracking sensitivity: 0
- Accel./decel. tracking: +1
- AF pt auto switching: +1

Geared for tracking moving subjects whose speed can change dramatically and suddenly. Also, if the target subject moves dramatically up, down, left or right and it is difficult to focus, the AF point switches automatically to track the subject.

It is recommended to use this setting with the following modes; AF point expansion (manual selection \square), AF point expansion (manual selection), surrounding points), Zone AF, Large Zone AF, and Automatic selection AF. With Single-point Spot AF or Single-point AF mode, the tracking action will be the same as with Case 4.



- If the subject is in motion, and prone to sudden, dramatic changes in speed, setting **[Accel./decel. tracking]** to **[+2]** may give better results (p.119).
- If the subject moves even more dramatically up, down, left, or right, setting **[AF pt auto switching]** to **[+2]** may give better results (p.120).

Parameters

● Tracking sensitivity

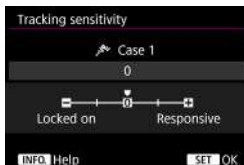

Sets the subject-tracking sensitivity during AI Servo AF when an obstacle cuts across the AF points or when the subject strays from the AF point.

0
Default setting. Suitable for moving subjects in general.

Locked on: -2 / Locked on: -1

The camera will try to continue focusing on the subject even if an obstacle cuts across the AF points or if the subject strays from the AF points. The -2 setting makes the camera keep tracking the target subject longer than the -1 setting.

However, if the camera focuses on a wrong subject, it may take slightly longer to switch and focus on the target subject.

Responsive: +2 / Responsive: +1

The camera can focus consecutively on subjects at different distances that are covered by the AF points. Also effective when you want to always focus on the closest subject. The +2 setting is more responsive than the +1 setting when focusing on the next subject. However, the camera will be more prone to focus on an unintended subject.

 [Tracking sensitivity] is the feature named [AI Servo tracking sensitivity] in the EOS-1D Mark III/IV, EOS-1Ds Mark III, and EOS 7D.

● Acceleration/deceleration tracking



This sets the tracking sensitivity for moving subjects whose speed can momentarily change dramatically by starting or stopping suddenly, etc.

0

Suited for subjects that move at a steady speed (minor changes in moving speed).

-2 / -1

Suited for subjects that move at a steady speed (minor changes in moving speed). It is effective when 0 is set but focus is unstable due to the subject's slight movement or an obstacle in front of the subject.

+2 / +1

Effective for subjects having sudden movements, sudden acceleration/deceleration, or sudden stops. Even if the moving subject's speed suddenly changes dramatically, the camera continues to focus on the target subject. For example, for an approaching subject, the camera becomes less prone to focus behind it to avoid subject blur. For a subject stopping suddenly, the camera becomes less prone to focus in front of it. Setting +2 can track dramatic changes in the moving subject's speed better than with +1.

However, since the camera will be sensitive to even slight movements of the subject, the focusing may become unstable for short periods.

● AF point auto switching

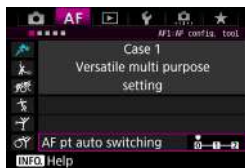

This sets the switching sensitivity of the AF points as they track the subject moving dramatically up, down, left, or right.

This setting takes effect when the AF area selection mode is set to AF point expansion (manual selection \square), AF point expansion (manual selection, surrounding points), Zone AF, Large Zone AF, or Automatic selection AF.

0

Standard setting for gradual AF point switching.

+2 / +1

Even if the target subject moves dramatically up, down, left, or right and moves away from the AF point, the camera switches its focus to neighboring AF points to continue focusing on the subject. The camera switches to the AF point deemed most likely to focus on the subject based on the subject's continual movement, contrast, etc. Setting +2 makes the camera more prone to switch the AF point than with +1.

However, with a wide-angle lens having a wide depth of field or if the subject is too small in the frame, the camera may focus with the unintended AF point.

Changing Cases' Parameter Settings

You can manually adjust each case's three parameters: 1. Tracking sensitivity, 2. Acceleration/deceleration tracking, and 3. AF point auto switching.

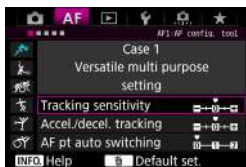

1 Select a case.

- Turn the <DIAL> dial to select the icon of the case you want to adjust.

2 Press the <MENU/OK> button.

- The selected parameter will be highlighted with a purple frame.



3 Select the parameter to adjust.

- Select the parameter to adjust, then press <SET>.
- If you select [Tracking sensitivity] or [Accel./decel. tracking], the setting screen will appear.



4 Make the adjustment.

- Adjust the setting, then press <SET>.
- ▶ The adjustment is saved.
- The default setting is indicated by the light gray [] mark.
- To return to the screen in step 1, press the <MENU/OK> button.



- In step 2, if you press the <MENU/OK> button, then press the <RESET> button, you can revert the 1, 2, and 3 parameter settings above for each case to their defaults.
- You can also register the 1, 2, and 3 parameter settings to My Menu (p.463). Doing so will change the selected case's settings.
- When shooting with a case whose parameters you adjusted, select the adjusted case, then take the picture.

MENU Customizing AF Functions

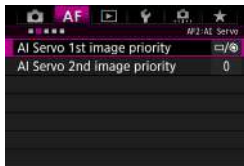

With the [AF2] to [AF5] menu tabs, you can set the AF functions to suit your shooting style or subject.

AF2: AI Servo

AI Servo 1st image priority

You can set the AF operation characteristics and shutter-release timing for the first shot with AI Servo AF.



Equal priority

Equal priority is given to focusing and shutter release.

Release priority

Pressing the shutter button takes the picture immediately even if focus has not been achieved. Useful when you want to give priority to capturing the image rather than achieving focus.

Focus priority

Pressing the shutter button does not take the picture until focus is achieved. Useful when you want to achieve focus before capturing the image.

AI Servo 2nd image priority

With AI Servo AF for continuous shooting, you can preset the AF operation characteristics and shutter-release timing for all shots to be taken after the first during continuous shooting.



0: Equal priority

Equal priority is given to focusing and continuous shooting speed. In low light or with low-contrast subjects, shooting speed may slow down.

-2/-1: Shooting speed priority

Priority is given to the continuous shooting speed instead of achieving focus. With -2, decrease of continuous shooting speed can be better prevented than with -1.

+2/+1: Focus priority

Priority is given to achieving focus instead of the continuous shooting speed. The picture will not be taken until focus is achieved. Although focus can be achieved easier in low-light conditions with +2 than with +1, continuous shooting speed may decrease.



Under shooting conditions which activate flicker reduction (p.198), even if **[Shooting speed priority]** is set to [-1] or [-2], the continuous shooting speed may become slower or the shooting interval may become irregular.



If focus cannot be achieved in low-light conditions when **[0: Equal priority]** is set, setting **[Focus priority]** to [+1] or [+2] may give better results.

AF3: One Shot

Lens electronic MF

With the following USM and STM lenses equipped with electronic manual focusing function, you can set whether to use electronic manual focusing.

EF50mm f/1.0L USM	EF300mm f/2.8L USM	EF600mm f/4L USM
EF85mm f/1.2L USM	EF400mm f/2.8L USM	EF1200mm f/5.6L USM
EF85mm f/1.2L II USM	EF400mm f/2.8L II USM	EF28-80mm f/2.8-4L USM
EF200mm f/1.8L USM	EF500mm f/4.5L USM	

EF40mm f/2.8 STM	EF50mm f/1.8 STM	EF24-105mm f/3.5-5.6 IS STM
------------------	------------------	-----------------------------

* As of January 2016.

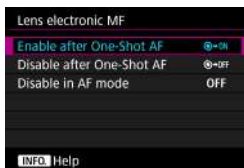

ON: Enable after One-Shot AF

After AF operates, if you keep pressing the shutter button halfway, you can adjust the focus manually.

OFF: Disable after One-Shot AF

After AF operates, manual focusing adjustment is disabled.

OFF: Disable in AF mode

When the lens's focus mode switch is set to <AF>, manual focusing is disabled.

AF-assist beam firing

Enables or disables the EOS dedicated external Speedlite's AF-assist beam.

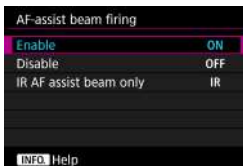

ON: Enable

The external Speedlite emits the AF-assist beam when necessary.

OFF: Disable

The external Speedlite will not emit the AF-assist beam. Useful when the AF-assist beam may disturb others.

IR: IR AF assist beam only

When an external Speedlite is attached, only the infrared AF-assist beam will be emitted. Useful when you do not want to fire a series of small flashes as the AF-assist light (Intermittent flash method).

With an EX-series Speedlite equipped with an LED light, the LED light will not automatically turn on as the AF-assist light.



If an external Speedlite's [**AF-assist beam firing**] Custom Function is set to [**Disable**], this function's setting will be overridden and the AF-assist beam will not be emitted.

One-Shot AF release priority

You can set the AF operation characteristics and shutter-release timing for One-Shot AF.

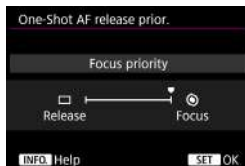

: Focus priority

The picture will not be taken until focus is achieved. Useful when you want to achieve focus before capturing the image.

: Release priority

Priority is given to the timing of shutter release instead of achieving focus. This gives priority to capturing the image rather than achieving precise focus.

Note that the picture will be taken even if focus has not been achieved.

AF4

Auto AF point selection: EOS iTR AF

EOS iTR* AF performs autofocus by recognizing faces and subject colors. EOS iTR AF works when the AF area selection mode is set to Zone AF, Large Zone AF, or Automatic selection AF.

* intelligent Tracking and Recognition: The function that the metering sensor identifies the subject to make the AF points tracking it.

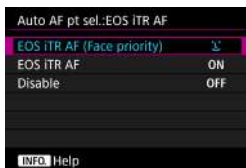

☺: EOS iTR AF (Face priority)

The AF point is automatically selected based not only on AF information, but also the human face and the subject's color information.

With AI Servo AF, the subject is tracked while giving higher priority to using facial information than with the [EOS iTR AF] setting. This makes it easier to keep track of the subject than when only AF information is available.

In One-Shot AF mode, EOS iTR AF makes focusing human faces easier, so you can shoot while concentrating on the composition.

ON: EOS iTR AF

The AF point is automatically selected based not only on AF information, but also the human face and the subject's color information. With AI Servo AF, the subject is tracked giving weight to the information on where (AF point) focus was first achieved, as well as facial information. The One-Shot AF operation will be the same as the [EOS iTR AF (Face priority)] setting.

OFF: Disable

AF points are automatically selected based only on AF information. (The AF does not use facial information or the subject's color information.)

- If **[EOS iTR AF (Face priority)]** or **[EOS iTR AF]** is set, the camera may take longer to focus than when **[Disable]** is set.
- Even if you set **[EOS iTR AF (Face priority)]** or **[EOS iTR AF]**, the desired result may not be obtained depending on the shooting conditions and subject.
- Under light so low that the EOS-dedicated, external Speedlite emits the AF-assist beam automatically, AF points are selected automatically based only on AF information.
- Face detection may not work if the face is small or under low-light conditions.

Lens drive when AF impossible

If focus cannot be achieved with autofocus, you can have the camera keep searching for the precise focus or have it stop searching.

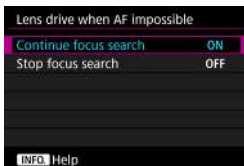

ON: Continue focus search

If focus cannot be achieved with autofocus, the lens is driven to search for the precise focus.

OFF: Stop focus search

If autofocus starts and the focus is far off or if focus cannot be achieved, the lens drive will not be performed. This prevents the lens from becoming grossly out of focus due to focus search drive.



- When using super telephoto lenses or other lenses with wide focusing drive ranges during focus search, the focus may become blurred and it may take more time to achieve focus next time. Setting [**Stop focus search**] is recommended.
- Even if [**Continue focus search**] is set, focus search may not be performed when a wide-angle lens is used.

Selectable AF point

You can change the number of manually selectable AF points. With Zone AF, Large Zone AF, or Automatic selection AF set, AF will be performed with the selected AF area selection mode (Zone AF, Large Zone AF, or Automatic selection AF) regardless of the [Selectable AF point] setting.

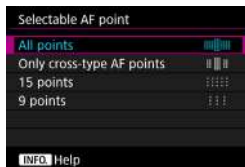

: All points

All AF points will be manually selectable.

: Only cross-type AF points

Only cross-type AF points will be manually selectable. The number of selectable AF points will vary depending on the lens used.

: 15 points

Fifteen major AF points will be manually selectable.

: 9 points

Nine major AF points will be manually selectable.

 With a lens from groups G to K (p.105-108), the number of manually selectable AF points will be lower.

-  • Even with settings other than [All points], AF point expansion (manual selection AF-ON), AF point expansion (manual selection, surrounding points), Zone AF, and Large Zone AF are still possible.
- When you press the <[INFO]> button, the AF points that are not manually selectable will not be displayed in the viewfinder.

Select AF area selection mode

You can limit the selectable AF area selection modes to suit your shooting preferences. Select the desired selection mode and press <SET> to add a checkmark [✓]. Then select [OK] to register the setting. The AF area selection modes are explained on pages 96-98.



- : **Manual select.:Spot AF**
- : **Manual selection:1 pt AF**
- : **Expand AF area:**
- : **Expand AF area:Surround**
- : **Manual select.:Zone AF**
- : **Manual select.:Large Zone AF**
- : **Auto selection AF**



- The [✓] mark cannot be removed from [**Manual selection:1 pt AF**].
- If the attached lens belongs to group I, J or K, you cannot use certain AF area selection modes even if you add a [✓] in [**Select AF area selec. mode**] (p.106 - 108).



AF area selection method



You can set the method for changing the AF area selection mode.





M-Fn :  → **M-Fn button**

After you press the < > button, pressing the <M-Fn> button changes the AF area selection mode.

 :  → **Main Dial**

After you press the < > button, turning the < > dial changes the AF area selection mode.

 When [ → **Main Dial**] is set, use the < > to move the AF point horizontally.

Orientation linked AF point

You can set the AF point or the AF area selection mode + AF point separately for vertical shooting and horizontal shooting.

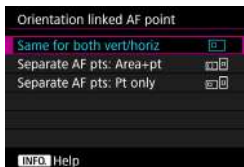

 : **Same for both vert/horiz**

The same AF area selection mode and manually-selected AF point (or zone) are used for both vertical shooting and horizontal shooting.

: **Separate AF pts: Area+pt**

The AF area selection mode and AF point (or zone) can be set separately for each camera orientation (1. Horizontal, 2. Vertical with the camera grip at the top, 3. Vertical with the camera grip at the bottom).

When you manually select the AF area selection mode and AF point (or zone) for each of the three camera orientations, they will be registered for the respective orientation. Whenever you change the camera orientation during shooting, the camera will switch to the AF area selection mode and manually-selected AF point (or zone) set for that orientation.

: **Separate AF pts: Pt only**

The AF point can be set separately for each camera orientation (1. Horizontal, 2. Vertical with the camera grip at the top, 3. Vertical with the camera grip at the bottom). While using the same AF area selection mode, the AF point will switch automatically for the respective camera orientation.

When you manually select the AF point for each of the three camera orientations, it will be registered for the respective orientation. During shooting, the AF point will switch to the manually-selected one depending on the camera orientation. Even if you change the AF area selection mode to Manual select.:Spot AF, Manual selection:1 pt AF, Expand AF area:, or Expand AF area: Surround, the AF point set for the respective orientation will be retained.

If you change the AF area selection mode to Zone AF or Large Zone AF, the zone will switch to the manually-selected one for the respective camera orientation.



- If you clear the camera settings to their defaults (p.77), the setting will be [**Same for both vert/horiz**]. Also, your settings for the three camera orientations (1, 2 and 3) will be cleared and all three will revert to Single-point AF with the center AF point selected.
- If you set this and later attach a lens from a different AF group (p.102-108, particularly group I, J, or K), the setting may be cleared.

Initial AF Point, (C) AI Servo AF

You can set the AI Servo AF's starting AF point for when the AF area selection mode is set to Auto selection AF.



(C): Initial (C) AF pt selected

AI Servo AF will start with the manually-selected AF point when the AF operation is set to AI Servo AF and the AF area selection mode is set to Auto selection AF.

[icon]: Manual [icon] AF pt

If you switch from Manual select.:Spot AF, Manual selection:1 pt AF, Expand AF area: [icon], or Expand AF area:Surround to Auto selection AF, AI Servo AF will start with the AF point that was manually selected before the switch. Useful if you want AI Servo AF to start with the AF point that was selected before the AF area selection mode was switched to Auto selection AF.

After setting the AF area selection mode to Auto selection AF with the [6: Custom Controls] menu's [Metering and AF start] (p.448), [Switch to registered AF func.] (p.450) or [Register/recall shooting func] (p.456), during shooting with Manual select: Spot AF, Manual selection: 1 pt AF, Expand AF area: [icon], or Expand AF area: Surround, you can press the assigned button to start shooting with Auto selection AF set for the AI Servo AF using the last used AF point as the initial AF point.

AUTO: Auto

The AF point which AI Servo AF starts with is set automatically to suit the shooting conditions.

When [Manual [icon] AF pt] is set, AI Servo AF will start with the zone that corresponds to the manually-selected AF point even if you switch AF area selection mode to Zone AF or Large Zone AF.

AF5

AF point selection pattern

During manual AF point selection, the selection can either stop at the outer edge or it can cycle around to the opposite side.



 : **Stops at AF area edges**

Useful if you often use an AF point along the edge.

 : **Continuous**

Instead of stopping at the outer edge, the selection of AF point continues to the opposite side.



With [AF4: Initial AF pt,  AI Servo AF] set to [Initial  AF pt selected], the above setting will also work when you are selecting the initial AF point for AI Servo AF.

AF point display during focus

You can set whether to display the AF point(s) when AF starts, during AF, when focus is achieved, and while the metering timer is active after focus is achieved.

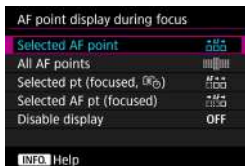
 : **Selected AF point**
 : **All AF points**
 : **Selected pt (focused, )**
 : **Selected AF pt (focused)**
OFF : **Disable display**

○: Displayed, ×: Not displayed

AF point display during focus	With AF point selected	Before AF starts (Camera shooting-ready)	At AF start
Selected AF point	○	×	○
All AF points	○	×	○
Selected pt (focused, )	○	×	○
Selected AF pt (focused)	○	×	○
Disable display	○	×	×

AF point display during focus	During AF	Focus achieved	Metering active after achieving focus
Selected AF point	○	○	○
All AF points	○	○	○
Selected pt (focused, )	×	○	○
Selected AF pt (focused)	×	○	×
Disable display	×	×	×

 When Large Zone AF or Automatic selection AF is set, the Large Zone AF frame or Area AF frame is displayed. Therefore, the AF point displayed/not displayed status will differ from the table above.

AF point brightness



: **Normal**

: **Brighter**

The AF points in the viewfinder will be displayed brighter.

AF status in viewfinder

The AF status icon indicating AF operation can be displayed in the viewfinder's field of view or outside the field of view.

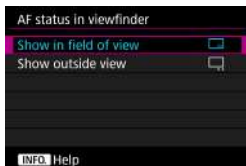

: **Show in field of view**

The AF status icon <AF> is displayed in the lower right of the viewfinder's field of view.

: **Show outside view**

The <▲> icon is displayed below the focus indicator <●> outside the viewfinder's field of view.

 See page 90 for the AF operation display.

AF Microadjustment

You can make fine adjustments for the AF's point of focus. For details, see "Fine Adjustment of AF's Point of Focus" on the next page.

MENU Fine Adjustment of AF's Point of Focus

Fine adjustment of the AF's point of focus is possible for viewfinder shooting. This is called "AF Microadjustment". Before making the adjustment, read "General Cautions for AF Microadjustment" and "Notes for AF Microadjustment" on page 143.

Normally, this adjustment is not required. Perform this adjustment only if necessary. Note that performing this adjustment may prevent accurate focusing from being achieved.

Adjust All by Same Amount

Set the adjustment amount manually by repeatedly making adjustments, shooting, and checking the results until the desired result is achieved. During AF, regardless of the lens used, the point of focus will always be shifted by the adjustment amount.

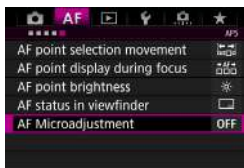

1 Select [AF Microadjustment].

- Under the [AF5] tab, select [AF Microadjustment], then press <SET>.

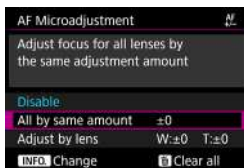

2 Select [All by same amount].

3 Press the <INFO.> button.

- The [All by same amount] screen will appear.

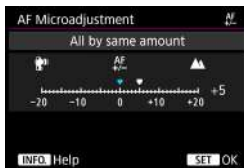

4 Make the adjustment.

- Set the adjustment amount. The adjustable range is ± 20 steps.
- Setting it toward “-: ” will shift the point of focus in front of the standard point of focus.
- Setting it toward “+: ” will shift the point of focus to the rear of the standard point of focus.
- After making the adjustment, press $\langle \text{SET} \rangle$.
- Select **[All by same amount]**, then press $\langle \text{SET} \rangle$.

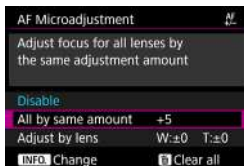

5 Check the result of the adjustment.

- Take a picture and play back the image (p.344) to check the adjustment result.
- If the shooting result comes out with focus in front of the targeted point, adjust toward the “+: ” side. If it comes out with focus behind the targeted point, adjust toward the “-: ” side.
- If necessary, repeat the adjustment.

If **[All by same amount]** is selected, separate AF adjustment will not be possible for the wide-angle and telephoto ends of zoom lenses.

Adjust by Lens

You can make the adjustment for each lens and register the adjustment in the camera. You can register the adjustment for up to 40 lenses. When you autofocus with a lens whose adjustment is registered, the point of focus will always be shifted by the adjustment amount. Set the adjustment manually by repeatedly making adjustments, shooting, and checking the results until the desired result is achieved. If you use a zoom lens, make the adjustment for the wide-angle (W) and telephoto (T) ends.

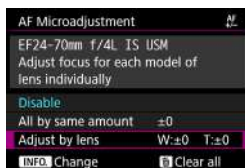

1 Select [Adjust by lens].



2 Press the <INFO.> button.

- ▶ The [Adjust by lens] screen will appear.

3 Check and change the lens information.

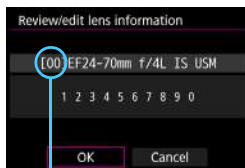

Registered number

Displaying the Lens Information

- Press the <Q> button.
- ▶ The screen will show the lens name and a 10-digit serial number. When the serial number is displayed, select [OK] and go to step 4.
- If the lens's serial number cannot be confirmed, "0000000000" will be displayed. In this case, enter the number by following the instructions on the next page.
- Regarding the asterisk "*" displayed in front of some lens serial numbers, see the next page.



Entering the Serial Number

- Select the digit to be entered, then press $\langle \text{SET} \rangle$ so $\langle \text{☐} \rangle$ is displayed.
- Enter the number, then press $\langle \text{SET} \rangle$.
- After entering all the digits, select $\langle \text{OK} \rangle$.

Lens Serial Number

- In step 3, if “*” appears in front of the 10-digit lens serial number, you can register only one unit of the same lens model. Even if you enter the serial number, “*” will remain displayed.
- The serial number on the lens may differ from the serial number displayed on the screen in step 3. This is not a malfunction.
- If the lens serial number includes letters, enter only the numbers.
- If the lens serial number is eleven digits or longer, enter only the last ten digits.
- The location of the serial number varies depending on the lens.
- Some lenses may not have a serial number inscribed. To register a lens that has no serial number inscribed, enter any serial number.



- If **[Adjust by lens]** is selected and an Extender is used, the adjustment will be registered for the lens and Extender combination.
- If 40 lenses have already been registered, a message will appear. After you select a lens whose registration is to be erased (overwritten), you can register another lens.

Single focal length lens



Zoom lens

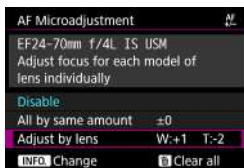

4 Make the adjustment.

- For a zoom lens, select the wide-angle (W) or telephoto (T) end. Pressing **<SET>** will turn off the purple frame and make the adjustment possible.
- Set the adjustment amount, then press **<SET>**. The adjustable range is ± 20 steps.
- Setting it toward “-: 📷” will shift the point of focus in front of the standard point of focus.
- Setting it toward “+: ▲” will shift the point of focus to the rear of the standard point of focus.
- For a zoom lens, repeat this procedure and adjust it for the wide-angle (W) and telephoto (T) ends.
- After completing the adjustment, press the **<MENU>** button to return to the screen in step 1.
- Select [**Adjust by lens**], then press **<SET>**.



5 Check the result of the adjustment.

- Take a picture and play back the image (p.344) to check the adjustment result.
- If the shooting result comes out with focus in front of the targeted point, adjust toward the “+: ▲” side. If it comes out with focus behind the targeted point, adjust toward the “-: 📷” side.
- If necessary, repeat the adjustment.



When shooting with the intermediate range (focal length) of a zoom lens, the AF's point of focus is corrected automatically relative to the adjustments made for the wide-angle and telephoto ends. Even if only the wide-angle or telephoto end is adjusted, a correction will be made automatically for the intermediate range.

Clearing All AF Microadjustments

When [ **Clear all**] appears at the bottom of the screen, pressing the <  > button will clear all the adjustments made for [**All by same amount**] and [**Adjust by lens**].



General Cautions for AF Microadjustment

- The AF's point of focus will vary slightly depending on the subject conditions, brightness, zoom position, and other shooting conditions. Therefore, even if you perform AF Microadjustment, focus may still not be achieved at the suitable position.
- The adjustment amount of one stop varies depending on the maximum aperture of the lens. Keep adjusting, shooting, and checking the focus repeatedly to adjust the AF's point of focus.
- The adjustment will not be applied to AF during Live View shooting or movie shooting.
- The adjustments will be retained even if you clear all the camera settings (p.77). However, the setting itself will be [**Disable**].



Notes for AF Microadjustment

- It is best to make the adjustment at the actual location where you will shoot. This will make the adjustment more precise.
- Using a tripod when making the adjustment is recommended.
- To check the result of the adjustment, set the image size to JPEG L (Large) and the JPEG quality (compression) to 8 or higher.

When Autofocus Fails

Autofocus can fail to achieve focus (viewfinder's focus indicator <●> blinks) with certain subjects such as the following:

Subjects Difficult to Focus

- Subjects with very low contrast
(Example: Blue skies, solid-color flat surfaces, etc.)
- Subjects in very low light
- Strongly backlit or reflective subjects
(Example: Cars with highly reflective bodies, etc.)
- Near and distant subjects framed close to an AF point
(Example: Animals in cages, etc.)
- Subjects such as dots of light framed close to an AF point
(Example: Night scenes, etc.)
- Subjects with repetitive patterns
(Example: Skyscraper windows, computer keyboards, etc.)
- Subjects with finer patterns than an AF point
(Example: Faces or flowers as small as, or smaller than an AF point, etc.)

In such cases, focus by doing either of the following:

- (1) With One-Shot AF, focus on an object at the same distance as the subject and lock the focus, then recompose the shot (p.89).
- (2) Set the lens's focus mode switch to <MF> and focus manually (p.145).



- Depending on the subject, focus may be achieved by slightly recomposing the shot and performing AF operation again.
- For conditions that make focusing difficult with AF during Live View shooting or movie shooting, see page 289.

MF: Manual Focus

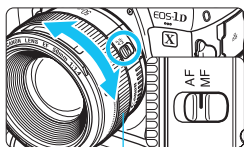

Focusing ring

1 Set the lens's focus mode switch to <MF>.

2 Focus on the subject.

- Focus by turning the lens's focusing ring until the subject looks sharp in the viewfinder.



- If you manually focus while pressing the shutter button halfway, the focus indicator <●> will light up when focus is achieved.
- With Automatic selection AF, when the center AF point achieves focus, the focus indicator <●> will light up.

Selecting the Drive Mode

Single and continuous drive modes are provided. You can select the drive mode suiting the scene or subject.

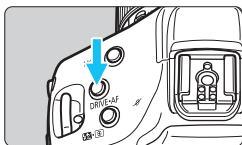

- 1 Press the <DRIVE•AF> button () .

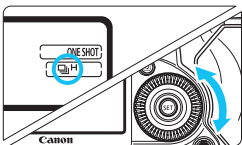

- 2 Select the drive mode.
 - While looking at the top LCD panel or in the viewfinder, turn the < > dial.

Single shooting

When you press the shutter button completely, only one shot will be taken.

H (): High-speed continuous shooting

While you hold down the shutter button completely, you can shoot continuously at **approx. 14.0 shots/sec. maximum** (with LP-E19 / DR-E19+AC-E19 (p.483)).

Under [ 4: Continuous shooting speed], if you set [High speed] to [14 (16) fps] (p.431), you can shoot continuously at approx. 16.0 shots/sec. maximum during Live View shooting.

The maximum continuous shooting speed will vary depending on the shooting conditions. For details, see pages 148-149.

L: Low-speed continuous shooting

While you hold down the shutter button completely, you can shoot continuously at **approx. 3.0 shots/sec. maximum**.

S (S): Single: Silent shooting

You can shoot one image at a time while suppressing the mechanical sound during viewfinder shooting. The internal mechanical operation is not executed until you return the shutter button to its halfway position.

S H (HS): Silent HS shooting

You can shoot continuously at **approx. 5.0 fps maximum** while suppressing the mechanical sound during viewfinder shooting (as compared to the < H> setting).

S L (LS): Silent LS shooting



You can shoot continuously at **approx. 3.0 fps maximum** while suppressing the mechanical sound during viewfinder shooting (as compared to the < L> setting).

10 (10): 10-sec. self-timer

2: 2-sec. self-timer

For self-timer shooting, see page 150.



- During Live View shooting or when [Enable: Mirror down w/SET] is set for mirror lockup, even if drive mode is set to <S>, <S  H>, or <S  L>, these silent drive modes will not further reduce the mechanical sound. (The only reduction of the mechanical sound is the effect of the Silent Live View shooting or mirror lockup mechanism.)
- If the camera's internal temperature is high and the drive mode icon is blinking, the maximum continuous shooting speed will become slower to prevent internal damage to the camera. Set the power switch to <OFF> and let the camera rest for a while.



The continuous shooting speed indicated for each drive mode is the camera's default speed. With [. 4: Continuous shooting speed], you can set the continuous shooting speed for each drive mode (p.431).

<H> High-Speed Continuous Shooting Speeds

Under [**4: Continuous shooting speed**], with [**High speed**] set to [**14 (16) fps**] (p.431), the maximum speed for <H> high-speed continuous shooting will be as follows:



(Max. approx. fps)

Power Source	ISO speed	Viewfinder shooting			Live View shooting
		Flicker reduction			
		No Flicker reduction	With Flicker reduction		
			100 Hz light source	120 Hz light source	
With Battery Pack LP-E19 (provided)	ISO 51200 or lower (at low temperatures: ISO 25600 or lower)	14.0	11.1	10.9	16.0
	H1 (equivalent to ISO 102400) or higher (at low temperatures: ISO 32000 or higher)	10.0			14.0
With Battery Pack LP-E4N/LP-E4	ISO 51200 or lower (at low temperatures: ISO 25600 or lower)	12.0	11.1	10.9	16.0
	H1 (equivalent to ISO 102400) or higher (at low temperatures: ISO 32000 or higher)	10.0			14.0
With household power outlet accessories (p.483) DR-E19+AC-E19	ISO 51200 or lower (at low temperatures: ISO 25600 or lower)	14.0	11.1	10.9	16.0
	H1 (equivalent to ISO 102400) or higher (at low temperatures: ISO 32000 or higher)	10.0			14.0
With AC Adapter Kit ACK-E4	–	8.0	7.7	8.0	14.0

- The <H> high-speed continuous shooting speed is the maximum attained under the following conditions: with a fully-charged battery pack, 1/1000 sec. or faster shutter speed, maximum aperture (varies depending on the lens)*, and no drive mode icon blinking.

* With the AF mode set to One-Shot AF and the Image Stabilizer turned off when using the following lenses: EF300mm f/4L IS USM, EF28-135mm f/3.5-5.6 IS USM, EF75-300mm f/4-5.6 IS USM, EF100-400mm f/4.5-5.6L IS USM.



- The continuous shooting speed for high-speed continuous shooting may become slower depending on the power source type, battery level, temperature, ISO speed, flicker reduction, shutter speed, aperture, subject's conditions, brightness, lens, flash use, shooting function settings, etc.
- As shown on the table on the preceding page, with H1 (equivalent to ISO 102400) or higher ISO speeds (ISO 32000 or higher if the camera's internal temperature is low), the maximum continuous shooting speed will become slower.
- When ISO Auto is set (p.165) or when safety shift (p.424) automatically changes the ISO speed, the maximum continuous shooting speed will be controlled according to the conditions shown in the table on the preceding page.
- With [ 3: Anti-flicker shoot.] set to [Enable] (p.198), shooting under flickering light will decrease the maximum continuous shooting speed. Also, the continuous shooting may become irregular and the time lag until the shot is taken may become longer.
- With AI Servo AF, the maximum continuous shooting speed may become slower depending on the subject's conditions and the lens used.
- The maximum continuous shooting speed may decrease if the battery level is lower than 50% or if you shoot under low-light conditions.
- If the camera's internal temperature is high and the drive mode icon is blinking, the maximum continuous shooting speed will become slower to prevent internal damage to the camera. If you keep shooting and the camera's internal temperature keeps increasing, the maximum continuous shooting speed will greatly decrease or the camera will stop shooting until the internal temperature goes down. If the drive mode icon is blinking, set the power switch to <OFF> and stop shooting for a while.
- In low temperatures and the battery becomes extremely cold, the maximum continuous shooting speed may decrease to approx. 10.0 fps.
- If <S>, <SL> is set, the time lag from when you press the shutter button completely until the picture is taken will be longer than normal.
- When internal memory becomes full during continuous shooting, the continuous shooting speed may drop off because shooting will be temporarily disabled (p.161).

📷 Using the Self-timer

Use the self-timer when you want to be in the picture.

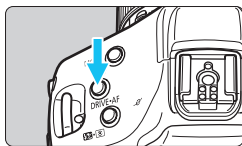

1 Press the <DRIVE•AF> button
(📷6).

2 Select the self-timer.

- While looking at the top LCD panel or in the viewfinder, turn the <📷> dial.

📷¹⁰ : Shoot in approx. 10 sec.

📷₂ : Shoot in approx. 2 sec.

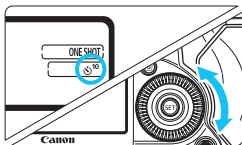

3 Take the picture.

- Look through the viewfinder, focus on the subject, then press the shutter button completely.
- ▶ You can check the self-timer operation with the blinking of self-timer lamp and countdown display (in seconds) on the top LCD panel.
- ▶ The lamp's blinking will become faster two seconds before the picture is taken.

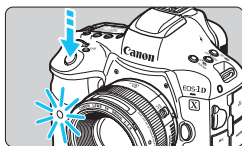

⚠ If you do not look through the viewfinder when you press the shutter button, close the eyepiece shutter before shooting (p.258). If stray light enters the viewfinder when the picture is taken, it may throw off the exposure.

- The <📷₂> enables you to shoot while not touching the camera mounted on a tripod. This prevents camera vibration blur when you shoot still lifes or long exposures.
- After taking self-timer shots, playing back the image (p.344) to check focus and exposure is recommended.
- When using the self-timer to shoot yourself, use focus lock (p.89) on an object at the same distance as where you will stand.
- Even if [📷3: Beep] is set to [Enable], there will be no beeping during the self-timer.
- To cancel the self-timer, set the power switch to <OFF>.

3

Image Settings

This chapter explains image-related function settings: Image-recording quality, ISO speed, Picture Style, white balance, Auto Lighting Optimizer, noise reduction, highlight tone priority, lens aberration correction, anti-flicker shooting, and other functions.

MENU Selecting the Card for Recording and Playback

If either a CF card or CFast card is inserted in the camera, you can start recording captured images. When only one card is inserted, you do not have to follow the procedures described on pages 152-154.

If you insert both cards, you can select the recording method and select which card to use for recording and playing back images.

[1] indicates the CF card, and [2] the CFast card.

Recording Method with Two Cards Inserted

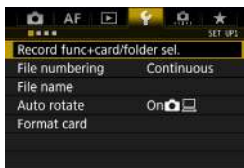

1 Select [Record func+card/folder sel.].

- Under the [1] tab, select [Record func+card/folder sel.], then press <SET>.

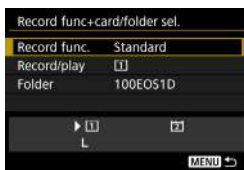

2 Select [Record func.].

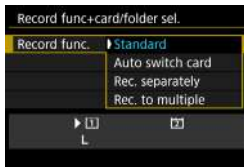

3 Select the recording method.

- Select the recording method, then press <SET>.

- **Standard**

Images will be recorded to the card selected with **[Record/play]**.

- **Auto switch card**

Same as with the **[Standard]** setting, but if the card becomes full, the camera will automatically switch to the other card to record images. When the card is automatically switched, a new folder will be created.

- **Rec. separately**

You can set the image-recording quality for each card (p.155). Each image is recorded to both the CF and CFast cards at the image-recording quality you set. You can freely set the image-recording quality, such as to **L** and **RAW**, **M2** and **S RAW**, etc.

- **Rec. to multiple**

Each image is recorded to both the CF and CFast cards simultaneously at the same image size. You can also select RAW+JPEG.



- If **[Rec. separately]** is set and different image sizes are set for the CF card and CFast card, the maximum burst for continuous shooting will decrease (p.158).
- Movies cannot be recorded simultaneously to the CF card and CFast card. Movies will be recorded to the card set for **[Playback]**.



[Rec. separately] and [Rec. to multiple]

- The same file number is used for recording to both the CF card and CFast card.
- The viewfinder and top LCD panel will display the number of possible shots of the card having the lower number.
- If one of the cards becomes full, **[Card* full]** will be displayed and shooting will be disabled. If this happens, either replace the card or set **[Record func.]** to **[Standard]**, and select the card with remaining capacity to continue shooting.
- Regarding the **[1: Record func+card/folder sel.]** menu's **[Folder]**, see page 201.

Selecting the CF or CFast Card for Recording and Playback

If **[Record func.]** is set to **[Standard]** or **[Auto switch card]**, select the card for recording and playing back images.

If **[Record func.]** is set to **[Rec. separately]** or **[Rec. to multiple]**, select the card for playing back images.

● Using the Menu Screen to Select the Card

Standard / Auto switch card

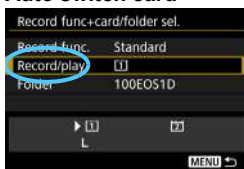

Rec. separately / Rec. to multiple

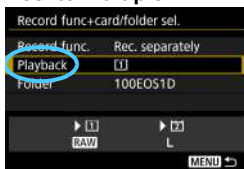

Select **[Record/play]**.

- Select **[Record/play]**, then press <SET>.

[1]: Record images to and play back images from the CF card.

[2]: Record images to and play back images from the CFast card.

- Select the card, then press <SET>.

Select **[Playback]**.

- Select **[Playback]**, then press <SET>.

[1]: Play back the CF card's images.

[2]: Play back the CFast card's images.

- Select the card, then press <SET>.

● Using the Rear LCD Panel to Select the Card

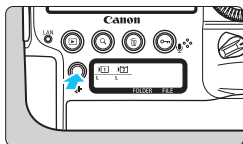

1 Press the <◀▶> button (ⓘ6).

Select the card.

- Turn the <⚙> dial to select a card.
- The card marked with <▶> can be used for **[Record/play]** or **[Playback]**.

Setting the Image-Recording Quality

You can set the image size (number of recorded pixels for JPEG/RAW) and JPEG quality (compression rate).

◀ Selecting the Image Size

JPEG is indicated by **L**, **M1**, **M2**, and **S**, and RAW is **RAW**, **M RAW**, and **S RAW**. After shooting, you can process RAW images with Digital Photo Professional (EOS software, p.550). Note that **RAW** images can also be processed with the camera (p.392).

You can set the image size in one of the two ways below.

● Using the Rear LCD Panel to Select the Image Size

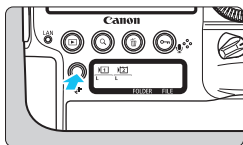

1 Press the <◀> button (ⓘ6).

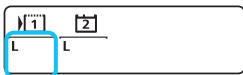

2 Select the desired image size.

- Turn the <☉> dial to select the image size.
- If **RAW/M RAW/S RAW** and **L/M1/M2/S** are displayed at the same time, the RAW and JPEG images will be recorded simultaneously to the card.
- Turn the <☀> dial to select the card to record or play back images (p.154).



- When **[Record func.]** is set to **[Rec. separately]** (p.153), turn the <☀> dial to select a card and set the image size for the respective card.
- In this manual, the image size and JPEG quality (p.162) are specified as the image-recording quality.

● Using the Menu Screen to Set the Image Size

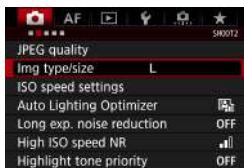

1 Select [Img type/size].

- Under the [CAMERA] tab, select [Img type/size], then press <SET>.

Standard / Auto switch card / Rec. to multiple

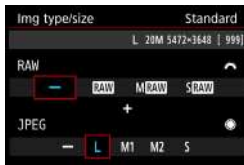

2 Set the image size.

- To select a RAW image size, turn the <DIAL> dial. To select a JPEG image size, turn the <WHEEL> dial.
- On the screen, the “****M (megapixels) **** x ****” number indicates the recorded pixel count, and [****] is the number of possible shots (displayed up to 9999).
- Press <SET> to set it.

Rec. separately



- Under [FUNC:1: Record func+card/ folder sel.], if [Record func.] is set to [Rec. separately], select CF card [CF1] or CFast card [CF2], then press <SET>.



- Select the desired image size, then press <SET>.

Image-recording Quality Setting Examples

L only



RAW only

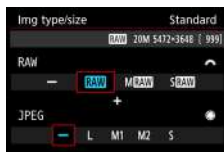

RAW + L



S RAW + M2



- If [-] is set for both the RAW and JPEG image sizes, **L** will be set.
- The number of possible shots will be displayed up to 999 in the viewfinder and on the top LCD panel.

Guide to Image Size Settings (Approx.)

Image Size	Pixels Recorded	Print Size	File Size (MB)	Possible Shots	Maximum Burst		
					CF Card		CFast Card
					Standard	High Speed	
JPEG							
L	20 M	A2	6.2	1160	140	Full	Full
M1	13 M	A3	4.3	1650	190	Full	Full
M2	8.9 M	A3	3.4	2120	250	Full	Full
S	5.0 M	A4	2.2	3180	740	Full	Full
RAW							
RAW	20 M	A2	23.2	300	59	73	170
M RAW	11 M	A3	18.5	370	72	94	330
S RAW	5.0 M	A4	12.7	530	100	170	Full
RAW+JPEG							
RAW L	20 M 20 M	A2+A2	23.2+6.2	230	48	54	81
M RAW L	11 M 20 M	A3+A2	18.5+6.2	280	53	65	100
S RAW L	5.0 M 20 M	A4+A2	12.7+6.2	360	54	70	130

- The number of possible shots is based on Canon's testing standards and an 8 GB card.
- The maximum burst is with Canon's standard testing CF card (Standard: 8 GB, High speed: UDMA 7, 64 GB) and CFast card (CFast 2.0, 128 GB), and based on the following conditions set by the Canon's testing standard: Viewfinder shooting, High-speed continuous shooting, JPEG quality 8, ISO 100, and Standard Picture Style.
- **The file size, number of possible shots, and maximum burst will vary depending on the subject, card brand, ISO speed, Picture Style, Custom Functions, and other settings.**
- "Full" indicates that shooting is possible until the card becomes full with that image size.



- Even if you use a UDMA CF card or CFast card, the maximum burst indicator remains the same. However, the maximum burst shown in the table on the preceding page applies to continuous shooting.
- If you select both RAW and JPEG, the same image will be recorded simultaneously to the card in both RAW and JPEG at the image-recording qualities that were set. The two images will be recorded with the same file numbers (file extension: .JPG for JPEG and .CR2 for RAW).
- In accordance with the selected image size, the <JPEG> or <RAW> icon will be displayed on the right side in the viewfinder.
- The image size icons are as follows: **RAW** (RAW), **M RAW** (Medium RAW), **S RAW** (Small RAW), JPEG, **L** (Large), **M1** (Medium 1), **M2** (Medium 2), **S** (Small).

RAW Images

A RAW image is raw data output by the image sensor converted to digital data. It is recorded to the card as is, and you can select the quality as follows: **RAW**, **M RAW**, or **S RAW**.

A **RAW** image can be processed with [▶] **2: RAW image processing** (p.392) and saved as a JPEG image. (**M RAW** and **S RAW** images cannot be processed with the camera.) As the RAW image itself does not change, you can process the RAW image to create any number of JPEG images with various processing conditions.

You can use Digital Photo Professional (EOS software, p.550) to process RAW images. You can make various adjustments to images depending upon how they will be used and generate JPEG, TIFF, or other types of images reflecting the effects of those adjustments.



RAW Image Processing Software

- To display RAW images on a computer, using Digital Photo Professional (DPP, EOS software) is recommended.
- Previous versions of DPP Ver.4.x cannot process RAW images taken with this camera. If a previous version of DPP Ver.4.x is installed on your computer, update it with the EOS Solution Disk (p.551). (The previous version will be overwritten.) Note that DPP Ver.3.x or earlier cannot process RAW images taken with this camera.
- Commercially-available software may not be able to display RAW images taken with this camera. For compatibility information, contact the software manufacturer.

One-touch Image Quality Setting

With Custom Controls, you can assign the image size to the <M-Fn> button, Multi function button 2, or depth-of-field preview button so you can switch to it temporarily. If you assign **[One-touch image quality setting]** or **[One-touch image quality (hold)]** to one of these buttons, you can switch the image-recording quality quickly and shoot. For details, see Custom Controls (p.443).

! Under [**1: Record func+card/folder sel.**], if [**Record func.**] is set to [**Rec. separately**], you cannot switch to the One-touch image quality setting.

Maximum Burst for Continuous Shooting

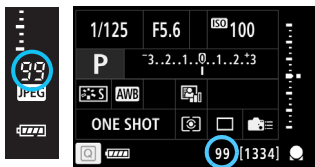

The approximate maximum burst is displayed on the viewfinder's right side, on the Quick Control screen, and on the bottom of the Custom Quick Control screen.

If the maximum burst for continuous shooting is 99 or higher, "99" will be displayed.

! The maximum burst is displayed even when a card is not inserted in the camera. Make sure that a card is inserted before taking a picture.

! If the maximum burst is displayed as "99", it indicates that you can shoot 99 or more shots continuously. If the maximum burst decreases to 98 or lower and the internal buffer memory becomes full, "buSY" will be displayed in the viewfinder and on the top LCD panel. Shooting will then be disabled temporarily. If you stop continuous shooting, the maximum burst will increase. After all the captured images are written to the card, you can resume continuous shooting and shoot up to the maximum burst listed in the table on page 158.

MENU Setting the JPEG Quality

For JPEG images, the recording quality (compression rate) can be set separately for each image size: **L**, **M1**, **M2**, and **S**.

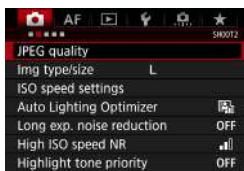

1 Select [JPEG quality].

- Under the [**2**] tab, select [**JPEG quality**], then press **<SET>**.

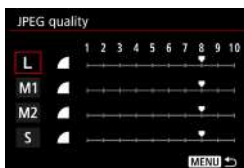

2 Select the desired image size.

- Select the image size, then press **<SET>**.

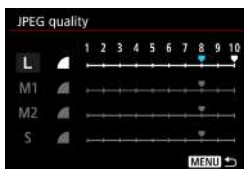

3 Set the desired quality (compression rate).

- Select the number, then press **<SET>**.
- The higher the number, the higher the quality will be (lower compression).
- For 6 - 10, **<▲>** is displayed. For 1 - 5, **<■>** is displayed.

 The higher the recording quality, the fewer the number of possible shots will be. On the other hand, the lower the recording quality, the higher the number of possible shots will be.

ISO: Setting the ISO Speed for Still Photos

Set the ISO speed (image sensor's sensitivity to light) to suit the ambient light level.

Regarding the ISO speed during movie shooting, see pages 299 and 302.

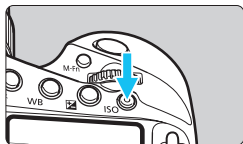

1 Press the <ISO> button (ⓘ6).

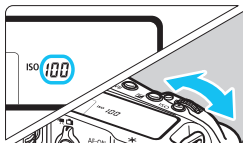

2 Set the ISO speed.

- While looking at the top LCD panel or the viewfinder, turn the <ⓘ> or <ⓘ> dial.
- ISO speed can be set within ISO 100 - ISO 51200 in 1/3-stop increments.
- “A” indicates ISO Auto. The ISO speed will be set automatically (p.165).

ISO Speed Guide

ISO speed	Shooting Situation (No flash)	Flash Range
L (50), ISO 100 - ISO 400	Sunny outdoors	The higher the ISO speed, the farther the effective flash range will be.
ISO 400 - ISO 1600	Overcast skies or evening time	
ISO 1600 - ISO 51200, H1 (102400), H2 (204800), H3 (409600)	Dark indoors or night	

* High ISO speeds will result in grainier images.



You can also set the ISO speed with the [📷2: ISO speed settings] menu's [ISO speed] screen.

- As H1 (equivalent to ISO 102400), H2 (equivalent to ISO 204800), and H3 (equivalent to ISO 409600) are expanded ISO speed settings, noise (dots of light, banding, etc.) and irregular colors will be more noticeable, and the resolution lower compared with the standard setting.
- As L (equivalent to ISO 50) is an expanded ISO speed setting, the dynamic range will be somewhat narrower compared with the standard setting.
- If [**2: Highlight tone priority**] is set to [**Enable**] (p.193), L (equivalent to ISO 50), ISO 100/125/160, H1 (equivalent to ISO 102400), H2 (equivalent to ISO 204800), and H3 (equivalent to ISO 409600) cannot be selected.
- When shooting with a high ISO speed, high temperature, long exposure, or multiple exposure, image noise (rough grain, dots of light, banding, etc.) and irregular colors may become noticeable.
- When shooting in conditions that produce an extreme amount of noise, such as a combination of high ISO speed, high temperature, and long exposure, images may not be recorded properly.
- If you use a high ISO speed and flash to shoot a close subject, overexposure may result.
- If H1 (equivalent to ISO 102400) or higher (ISO 32000 or higher if the camera's internal temperature is low) has been set, the maximum continuous shooting speed during high-speed continuous shooting will be no faster than approx. 10.0 fps during viewfinder shooting or approx. 14.0 fps during Live View shooting. For details, see page 148.

- Under [**2: ISO speed settings**], you can use [**Range for stills**] to expand the settable ISO speed range from L (equivalent to ISO 50) to H1 (equivalent to ISO 102400), H2 (equivalent to ISO 204800), and H3 (equivalent to ISO 409600) (p.166).
- Depending on the ISO speed setting, the shutter sound at the end of shooting may differ.

ISO Auto



If the ISO speed is set to “**A**” (Auto), the actual ISO speed to be set will be displayed when you press the shutter button halfway.

As indicated below, the ISO speed will be set automatically to suit the shooting mode.

Shooting Mode	ISO Speed Setting	
	No Flash	With Flash
P/Tv/Av/M	ISO 100 - ISO 51200 ^{*1}	ISO 400 ^{*1*2*3}
bulb	ISO 400 ^{*1}	

*1: The actual ISO speed range depends on the **[Minimum]** and **[Maximum]** settings set in **[Auto range]**.

*2: If fill-in flash will cause overexposure, ISO 100 or a higher ISO will be set. (Except in the **<M>** and **<bulb>** modes.)

*3: In the **<P>** mode, if you use bounce flash with an external Speedlite, ISO 400 - ISO 1600 will be set automatically.

! If H1 (equivalent to ISO 102400) or higher (ISO 32000 or higher if the camera's internal temperature is low) has been set automatically, the maximum continuous shooting speed during high-speed continuous shooting will be no faster than approx. 10.0 fps during viewfinder shooting or approx. 14.0 fps during Live View shooting. For details, see page 148.

MENU Setting the Manually-Settable ISO Speed Range

You can set the manually-settable ISO speed range (minimum and maximum limits). You can set the minimum limit within L (equivalent to ISO 50) to H2 (equivalent to ISO 204800), and the maximum limit within ISO 100 to H3 (equivalent to ISO 409600).

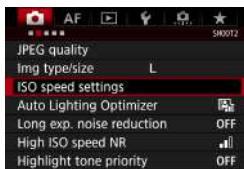
**1** Select [ISO speed settings].

- Under the [CAMERA] tab, select [ISO speed settings], then press <SET>.

**2** Select [Range for stills].**3** Set the minimum limit.

- Select the minimum limit box, then press <SET>.
- Select the ISO speed, then press <SET>.

**4** Set the maximum limit.

- Select the maximum limit box, then press <SET>.
- Select the ISO speed, then press <SET>.

5 Select [OK].

MENU Setting the ISO Speed Range for ISO Auto

You can set the automatic ISO speed range for ISO Auto within ISO 100 - ISO 51200. You can set the minimum limit within ISO 100 - ISO 25600, and the maximum limit within ISO 200 - ISO 51200 in 1-stop increments.

**1** Select **[Auto range]**.**2** Set the minimum limit.

- Select the minimum limit box, then press $\langle \text{SET} \rangle$.
- Select the ISO speed, then press $\langle \text{SET} \rangle$.

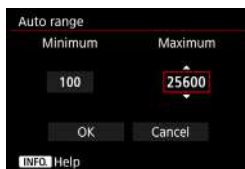
**3** Set the maximum limit.

- Select the maximum limit box, then press $\langle \text{SET} \rangle$.
- Select the ISO speed, then press $\langle \text{SET} \rangle$.

4 Select **[OK]**.

 The **[Minimum]** and **[Maximum]** settings will also be applied to the ISO speed safety shift's minimum and maximum ISO speeds (p.424).

MENU Setting the Minimum Shutter Speed for ISO Auto

You can set the minimum shutter speed so that the shutter speed set automatically will not be too slow when ISO Auto is set.

This is effective in the <P> and <Av> modes when you use a wide-angle lens to shoot a moving subject or when you use a telephoto lens. It helps to reduce camera shake and blurred subjects.

**1** Select [Min. shutter spd.].**Automatically set****2** Set the desired minimum shutter speed.

- Select [**Auto**] or [**Manual**].
- If you select [**Auto**], turn the <☀> dial to set the desired speed, slower or faster compared to the standard speed, then press <SET>.
- If you select [**Manual**], turn the <☀> dial to select the shutter speed, then press <SET>.

Manually set

- If a correct exposure cannot be obtained with the maximum ISO speed limit set with [**Auto range**], a shutter speed slower than the [**Min. shutter spd.**] will be set to obtain the standard exposure.
- This function will not be applied to flash and movie shooting.

When [**Auto: 0**] is set, the minimum shutter speed will be the reciprocal of the lens focal length. A single step from [**Slower**] to [**Faster**] is equivalent to a single shutter speed stop.

MENU Selecting a Picture Style

By selecting a Picture Style, you can obtain image characteristics matching your photographic expression or the subject.

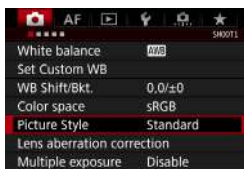

1 Select [Picture Style].

- Under the [**1**] tab, select [**Picture Style**], then press <SET>.
- ▶ The Picture Style selection screen will appear.



2 Select a Picture Style.

- Select a Picture Style, then press <SET>.
- ▶ The Picture Style will be set and the menu will reappear.

Picture Style Characteristics

Auto

The color tone will be adjusted automatically to suit the scene. The colors will look vivid for blue skies, greenery and sunsets, particularly in nature, outdoor and sunset scenes.



If the desired color tone is not obtained with [**Auto**], use another Picture Style.

Standard

The image looks vivid, sharp, and crisp. This is a general-purpose Picture Style suitable for most scenes.

Portrait

For nice skin tones. The image looks softer. Suited for close-up portraits.

By changing the [**Color tone**] (p.173), you can adjust the skin tone.

Landscape

For vivid blues and greens, and very sharp and crisp images.
Effective for impressive landscapes.

Fine Detail

Suited for detailed outline and fine texture description of the subject.
The colors will be slightly vivid.

Neutral

Suited for processing the image with a computer. For natural colors
and subdued images with modest brightness and color saturation.

Faithful

Suited for processing the image with a computer. The color of a
subject that is captured in sunlight at a color temperature of 5200K
will be adjusted to match the subject's colorimetric color. For
subdued images with modest brightness and color saturation.

Monochrome

Creates black-and-white images.

 Black-and-white images shot in JPEG cannot be turned into color. Be
careful not to leave the **[Monochrome]** setting on when you want to shoot
photos in color again. When **[Monochrome]** is selected, **<B/W>** will appear
on the top LCD panel.

 You can set to display **<M>** in the viewfinder for when **[Monochrome]** is
set (p.436).

User Def. 1-3

You can register a basic style such as **[Portrait]**, **[Landscape]**, a
Picture Style file, etc., and adjust it as desired (p.175). Any User
Defined Picture Style that is not set will have the same settings as
the **[Standard]** Picture Style.

Symbols

The Picture Style selection screen has icons for **[Strength]**, **[Fineness]**, or **[Threshold]** of **[Sharpness]**, **[Contrast]**, and other parameters. The numerals indicate the set values for these parameters set for the respective Picture Style.



Symbols

	Sharpness	
		Strength
		Fineness
		Threshold
	Contrast	
	Saturation	
	Color tone	
	Filter effect (Monochrome)	
	Toning effect (Monochrome)	

During movie shooting, “*,” “*” will be displayed for **[Fineness]** and **[Threshold]** of **[Sharpness]**. **[Fineness]** and **[Threshold]** will not be applied to movies.

MENU Customizing a Picture Style

You can customize the Picture Styles. You can change or adjust the parameter settings of Picture Styles such as [Strength], [Fineness], or [Threshold] of [Sharpness], and [Contrast], and other parameters from the default settings. To see the resulting effects, take test shots. To customize [Monochrome], see page 174.



1 Select [Picture Style].

- Under the [📷 1] tab, select [Picture Style], then press <SET>.
- The Picture Style selection screen will appear.



2 Select a Picture Style.

- Select a Picture Style, then press the <INFO.> button.

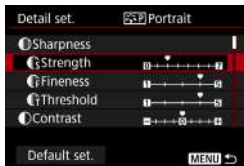

3 Select a parameter.

- Select the parameter (such as [Sharpness] - [Strength]) to be set, then press <SET>.
- The settings and effects are explained on the next page.



4 Set the parameter.

- Adjust the parameter as desired, then press $\langle \text{SET} \rangle$.
- Press the $\langle \text{MENU} \rangle$ button to save the adjusted parameters. The Picture Style selection screen will reappear.
- ▶ Any parameter settings different from the default will be displayed in blue.

Parameter Settings and Effects

	Sharpness		
●	Strength	0: Less sharp outline	7: Sharp outline
●	Fineness* ¹	1: Fine	5: Grainy
●	Threshold* ²	1: Low	5: High
●	Contrast	-4: Low contrast	+4: High contrast
●	Saturation	-4: Low saturation	+4: High saturation
●	Color tone	-4: Reddish skin tone	+4: Yellowish skin tone

*1: Indicates the fineness of the outlines to be emphasized. The smaller the number, the finer the outlines that can be emphasized.

*2: Sets how much the outline is emphasized based on the difference in contrast between the subject and the surrounding area. The smaller the number, the more the outline with low contrast difference can be emphasized. However, noise tends to be more noticeable when the number is smaller.



- For movie shooting, [Fineness] and [Threshold] for [Sharpness] cannot be set (not displayed).
- By selecting [Default set.] in step 3, you can revert the parameter settings of the respective Picture Style to their defaults.
- To shoot with the Picture Style you adjusted, first select the adjusted Picture Style, then shoot.

Monochrome Adjustment

Besides the effects described on the preceding page such as **[Contrast]**, or **[Strength]**, **[Fineness]** and **[Threshold]** of **[Sharpness]**, you can also set **[Filter effect]** and **[Toning effect]**.

Filter effect



With a filter effect applied to a monochrome image, you can make white clouds or green trees stand out more.

Filter	Sample Effects
N: None	Normal black-and-white image with no filter effects.
Ye: Yellow	The blue sky will look more natural, and the white clouds will look crisper.
Or: Orange	The blue sky will look slightly darker. The sunset will look more brilliant.
R: Red	The blue sky will look quite dark. Fall leaves will look crisper and brighter.
G: Green	Skin tones and lips will appear muted. Green tree leaves will look crisper and brighter.

 Increasing the **[Contrast]** will make the filter effect more pronounced.

Toning effect



By applying a toning effect, you can create a monochrome image in the selected color. Effective when you want to create more impressive images. The following can be selected: **[N:None]**, **[S:Sepia]**, **[B:Blue]**, **[P:Purple]** or **[G:Green]**.

MENU Registering a Picture Style

You can select a base Picture Style such as [Portrait] or [Landscape], adjust its parameters as desired and register it under [User Def. 1], [User Def. 2], or [User Def. 3]. Useful when you want to preset multiple Picture Styles with different settings.

You can also adjust the parameters of a Picture Style that is registered to the camera with EOS Utility (EOS software, p.550).

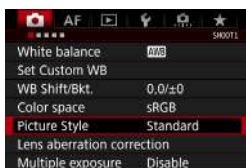

1 Select [Picture Style].

- Under the [📷1] tab, select [Picture Style], then press <SET>.
- ▶ The Picture Style selection screen will appear.



2 Select [User Def. *].

- Select [User Def. *], then press the <INFO.> button.



3 Press <SET>.

- With [Picture Style] selected, press <SET>.

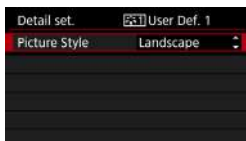

4 Select the base Picture Style.

- Select the base Picture Style, then press <SET>.
- To adjust the parameters of a Picture Style that is registered to the camera with EOS Utility (EOS software), select the Picture Style here.



5 Select a parameter.

- Select the parameter (such as **[Sharpness]** - **[Strength]**) to be set, then press **<SET>**.



6 Set the parameter.

- Adjust the parameter as desired, then press **<SET>**.

For details, see “Customizing a Picture Style” (p.172).



- Press the **<MENU>** button to register the modified Picture Style. The Picture Style selection screen will then reappear.
 - ▶ The base Picture Style will be indicated on the right of **[User Def. *]**.
 - ▶ If the settings in a Picture Style registered under **[User Def. *]** have been modified from the base Picture Style settings, the Picture Style's name will be displayed in blue.

- If a Picture Style is already registered under **[User Def. *]**, changing the base Picture Style in step 4 will clear the parameter settings of the previously registered User Defined Picture Style.
- If you perform **[Clear all camera settings]** (p.77), all the **[User Def. *]** styles and settings will revert to their defaults.

- To shoot with the Picture Style you adjusted, select the registered **[User Def. *]**, then shoot.
- Regarding the procedure to register a Picture Style file to the camera, refer to the EOS Utility Instruction Manual (p.4).

WB: Setting the White Balance

White balance (WB) is for making the white areas look white. Normally, the Auto [**AWB**] (Ambience priority) or [**AWB w**] (White priority) setting will obtain the correct white balance. If natural-looking colors cannot be obtained with Auto, you can select the white balance to match the light source or set it manually by shooting a white object.

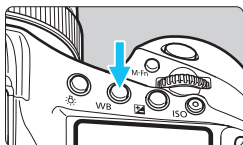

1 Press the **<WB>** button (☀️).

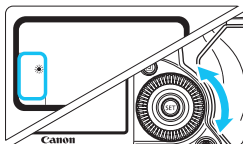

2 Select a white balance setting.

- While looking at the top LCD panel or in the viewfinder, turn the **<☀️>** dial.

(Approx.)

Display	Mode	Color Temperature (K: Kelvin)
AWB	Auto (Ambience priority, p.179)	3000 - 7000
AWB w	Auto (White priority, p.179)	
☀️	Daylight	5200
🏠	Shade	7000
☁️	Cloudy, twilight, sunset	6000
💡	Tungsten light	3200
💡	White fluorescent light	4000
⚡	Flash use	Automatically set*
📷	Custom (p.180)	2000 - 10000
K	Color temperature (p.185)	2500 - 10000

* Applicable with Speedlites having a color temperature transmission function. Otherwise, it will be fixed to approx. 6000 K.

- 
- You can also set this with the [**1: White balance**] screen.
 - To switch between Auto [**AWB**] (Ambience priority) and [**AWB w**] (White priority), use the [**1: White balance**] screen (p.179).
 - To set Personal white balance, select [**PC-***] in step 2 on the preceding page. To register a Personal white balance to the camera, refer to the EOS Utility Instruction Manual (p.4).

White Balance

To the human eye, a white object looks white regardless of the type of lighting. With a digital camera, the white for color correction basis is decided depending on the color temperature of the illumination, and then the color is adjusted with software to make the white areas look white. With this function, pictures with natural color tones can be taken.

[AWB] Auto White Balance

With **[AWB]** (Ambience priority), you can increase the intensity of the image's warm color cast when shooting a tungsten-light scene. If you select **[AWBw]** (White priority), you can reduce the intensity of the image's warm color cast.

If you want to match the Auto white balance of previous EOS camera models, select **[AWB]** (Ambience priority).



1 Select **[White balance]**.

- Under the **[CAMERA 1]** tab, select **[White balance]**, then press **<SET>**.

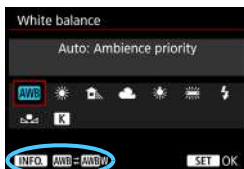

2 Select **[AWB]**.

- With **[AWB]** selected, press the **<INFO.>** button.



3 Select the desired item.

- Select **[Auto: Ambience priority]** or **[Auto: White priority]**, then press **<SET>**.

[AWB] : Auto: Ambience priority

[AWBw] : Auto: White priority



Cautions for Setting **[AWBw]** (White priority)

- The warm color cast of subjects may fade.
- When multiple light sources are included on the screen, the warm color cast of the picture may not be lessened.
- When using flash, the color tone will be the same as **[AWB]** (Ambience priority).

Custom White Balance

Custom white balance enables you to manually set the white balance for a specific light source. Make sure to perform this procedure under the light source at the actual location of the shoot.

Up to five sets of Custom white balance data can be registered to the camera. You can also append a name (caption) to the registered Custom white balance data.

MENU Registering Custom White Balance

There are two ways to register Custom white balance data. You can either take a picture and register it, or register an image already saved in the card.

● Record and register WB



1 Select [Set Custom WB].

- Under the [CAMERA 1] tab, select [Set Custom WB], then press <SET>.

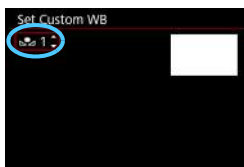

2 Select the Custom WB number to be registered.

- Press <SET>.
- Turn the <DIAL> dial to select 1 to 5 for <CAMERA *>, then press <SET>. The Custom WB data will be registered under the selected number.

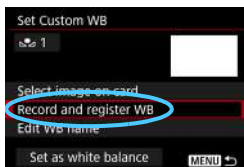

3 Select [Record and register WB].

- ▶ The LCD monitor will turn off, and the selected number will blink on the top LCD panel.

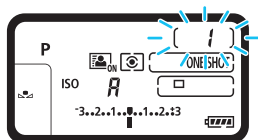

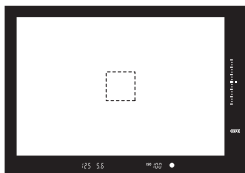

4 Photograph a solid-white object.

- Look through the viewfinder and aim the entire dotted line box (shown in the illustration) over a plain, white object.
 - Focus manually and shoot with the standard exposure set for the white object.
 - You can use any white balance setting.
- ▶ The Custom WB data will be registered to the camera.
- To use the Custom white balance, see “Selecting and Shooting with the Registered Custom WB Data” (p.183).

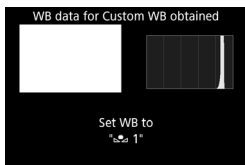

If the exposure obtained in step 4 differs greatly from the standard exposure, a correct white balance may not be obtained.



- Custom WB data can also be registered as follows:
 1. Press the <WB> button and turn the <WB> dial to select <WB> (p.177).
 2. Then turn the <WB> dial to select the number under which the Custom WB is to be registered.
 3. Press the <WB> button.
 - The number selected in step 2 will blink on the top LCD panel.
 4. Follow step 4 above to photograph a solid-white object.
 - The Custom WB data will be registered under the selected number.
- If [Correct WB may not be obtained with the selected image] is displayed in step 4, go back to step 1 and shoot again.
- The image captured in step 4 will not be recorded to the card.
- Instead of a white object, shooting a gray chart or 18% gray reflector (commercially-available) can produce a more accurate white balance.

● **Select image on card**



1 Shoot a solid-white object.

- Follow step 4 on the preceding page and photograph a solid-white object.

2 Select [Set Custom WB].

- Under the [CAM 1] tab, select [Set Custom WB], then press <SET>.

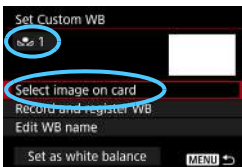

3 Select the Custom WB number to be registered.

- Press <SET>.
- Turn the <DISP> dial to select 1 to 5 for <[CAM]*>, then press <SET>. The Custom WB data will be registered under the selected number.

4 Select [Select image on card].

- ▶ The images saved in the card will be displayed.



5 Select the image to be used for registering the Custom WB data.

- Turn the <DISP> dial to select the image captured in step 1, then press <SET>.



6 Select [OK].

- ▶ The Custom WB data will be registered.
- Select [OK] to return to the screen in step 3.

! In step 5, the following images cannot be selected: Images captured with the Picture Style set to **[Monochrome]**, multiple-exposure images, Frame Grab from 4K movies, and images shot with another camera.

! To shoot with a registered Custom white balance, first select the number of the registered Custom white balance.

MENU Selecting and Shooting with the Registered Custom WB Data

- Registered image
- 1 Select the Custom WB number.**

 - On the **[Set Custom WB]** screen, select the number of the registered Custom white balance.
 - 2 Select [Set as white balance].**

 - The white balance will be set to the registered **<WB*>**.
 - 3 Take the picture.**

 - The picture will be taken with the **<WB*>** setting.

! You can also select the Custom WB number while looking at the top LCD panel. Press the **<WB>** button and turn the **<DIAL>** dial to select **<WB*>**. Then turn the **<WB>** dial to select the registered Custom WB number.

MENU Naming the Custom WB Data

You can also append a name (caption) to the five registered Custom white balance data (Custom WB No. 1-5).

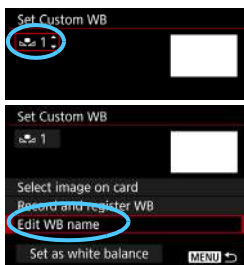

1 Select the Custom WB number.

- On the [Set Custom WB] screen, select the number of the Custom white balance you want to append a name to.

2 Select [Edit WB name].

3 Enter text.

- Operate the <⊙>, <☰>, or <☼> to move the and select the desired character. Then press <SET> to enter it.
- You can enter up to 20 characters.
- To delete a character, press the <🗑️> button.
- To cancel the text entry, press the <INFO.> button, then select [OK].

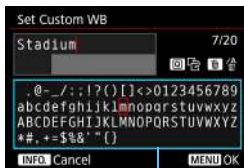

Character palette

4 Exit the setting.

- After entering the text, press the <MENU> button, then select [OK].
- The information will be saved and the screen will return to step 2.
- The entered name will be displayed below <☼*>.

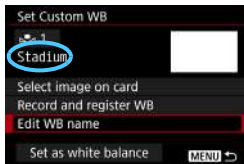

- If you cannot enter text in step 3, press the <☑> button and use the character palette when the blue frame appears.
- Entering a name that indicates the location where you registered the Custom white balance or the light source type of the registered Custom white balance is convenient.

K Setting the Color Temperature

You can set the white balance's color temperature numerically. This function is for advanced users.

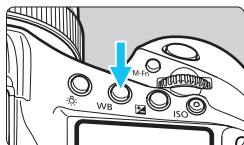

1 Press the **<WB>** button (ⓘ6).



2 Select **<K>**.

- Look at the top LCD panel and turn the **<☉>** dial to select **<K>**.



3 Set the color temperature.

- Turn the **<☉>** dial to set the color temperature.
- The color temperature can be set from approx. 2500 K to 10000 K in 100 K increments.



- When setting the color temperature for an artificial light source, set white balance correction (magenta or green) as necessary.
- If you set **<K>** to the reading taken with a commercially-available color temperature meter, take test shots and adjust the setting to compensate for the difference between the color temperature meter's reading and the camera's color temperature reading.



You can also set this with the [**1**: White balance] screen.

WB +/- White Balance Correction

You can correct the white balance that is set. This adjustment will have the same effect as using a commercially-available color temperature conversion filter or color compensating filter. Each color can be corrected to one of nine levels. This function is for advanced users, particularly for those users who understand the use of color temperature conversion and color compensating filters and their effects.

White Balance Correction



1 Select [WB Shift/Bkt.].

- Under the [1] tab, select [WB Shift/Bkt.], then press <SET>.

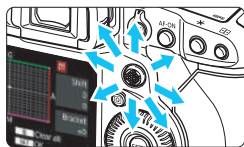

2 Set the white balance correction.

- Use <⬤> to move the "■" mark to the appropriate position.
- B is for blue, A for amber, M for magenta, and G for green. The image's color balance will be adjusted toward the color in the direction of the move.
- On the right of the screen, "Shift" indicates the direction and correction amount, respectively.
- Pressing the <⌫> button will cancel all the [WB Shift/Bkt.] settings.
- Press <SET> to exit the setting.

Sample setting: A2, G1

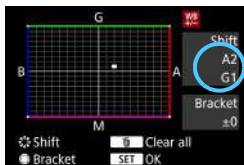

- During the white balance correction, <WB> will be displayed on the top LCD panel.
- You can set to display <ⓘ> in the viewfinder for when white balance correction is set (p.436).
- One level of the blue/amber correction is equivalent to approx. 5 mireds of a color temperature conversion filter. (Mired: Unit of measure for color temperature used to indicate values such as the density of a color temperature conversion filter.)

White Balance Auto Bracketing

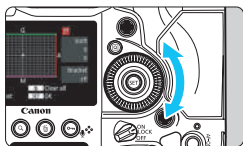

With just one shot, three images with different color tones can be recorded simultaneously. Based on the color temperature of the current white balance setting, the image will be bracketed with a blue/amber bias and magenta/green bias. This function is called white balance bracketing (WB-BKT). White balance bracketing is possible up to ± 3 levels in single-level increments.

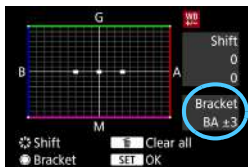

B/A bias ± 3 levels



Set the white balance bracketing amount.

- In step 2 for “White Balance Correction”, when you turn the  dial, the “■” mark on the screen will change to “■■■” (3 points). Turning the dial to the right sets the B/A bracketing, and turning it to the left sets the M/G bracketing.
- ▶ On the right, “**Bracket**” indicates the bracketing direction and correction amount.
- Pressing the  button will cancel all the [WB Shift/Bkt.] settings.
- Press  to exit the setting.

● Bracketing Sequence

The images will be bracketed in the following sequence: 1. Standard white balance, 2. Blue (B) bias, and 3. Amber (A) bias, or 1. Standard white balance, 2. Magenta (M) bias, and 3. Green (G) bias.

- During white balance bracketing, the maximum burst for continuous shooting will be lower.
- Since three images are recorded for one shot, it takes longer to record the image to the card.

- You can also set white balance correction and AEB together with white balance bracketing. If you set AEB in combination with white balance bracketing, a total of nine images will be recorded for a single shot.
- When white balance bracketing is set, the white balance icon will blink.
- You can change the sequence (p.422) and number of shots (p.423) for the white balance bracketing.
- “**Bkt.**” stands for bracketing.

MENU Auto Correction of Brightness and Contrast

If the image comes out dark or the contrast is low, the brightness and contrast can be corrected automatically. This function is called Auto Lighting Optimizer. The default setting is [Standard]. With JPEG images, the correction is applied when the image is captured.

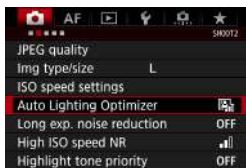

1 Select [Auto Lighting Optimizer].

- Under the [CAMERA] tab, select [Auto Lighting Optimizer], then press <SET>.

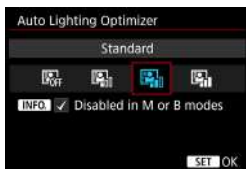

2 Select the setting.

- Select the desired setting, then press <SET>.

3 Take the picture.

- The image will be recorded with the brightness and contrast corrected if necessary.



- Depending on the shooting conditions, noise may increase.
- If the effect of Auto Lighting Optimizer is too strong and the image is too bright, set [Low] or [Disable].
- If a setting other than [Disable] is set and you use exposure compensation or flash exposure compensation to darken the exposure, the image may still come out bright. If you want a darker exposure, set this function to [Disable].
- When you set multiple exposures (p.248) or highlight tone priority (p.193), [Auto Lighting Optimizer] will be automatically set to [Disable].



In step 2, if you press the <INFO.> button and remove the [✓] mark for [Disabled in M or B modes] setting, the [Auto Lighting Optimizer] can be set even in the <M> and <bulb> modes.

MENU Setting Noise Reduction

High ISO Speed Noise Reduction

This function reduces the noise generated in the image. Although noise reduction is applied at all ISO speeds, it is particularly effective at high ISO speeds. When shooting at low ISO speeds, the noise in the darker parts of the image (shadow areas) can further be reduced.

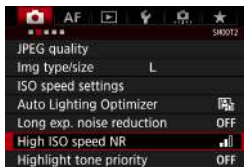

1 Select [High ISO speed NR].

- Under the [CAMERA] tab, select [High ISO speed NR], then press <SET>.



2 Set the level.

- Select the desired noise reduction level, then press <SET>.

3 Take the picture.

- The image will be recorded with noise reduction applied.

Long Exposure Noise Reduction

For images exposed for 1 sec. or longer, noise (dots of light and banding) typical of long exposures can be reduced.

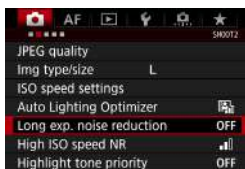

1 Select [Long exp. noise reduction].

- Under the [CAMERA] tab, select [Long exp. noise reduction], then press <SET>.

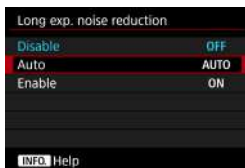

2 Set the desired setting.

- Select the desired setting, then press <SET>.

• Auto

For exposures of 1 sec. or longer, noise reduction is performed automatically if noise typical of long exposures is detected. This [Auto] setting is effective in most cases.

• Enable

Noise reduction is performed for all exposures of 1 sec. or longer. The [Enable] setting may reduce noise that cannot be detected with the [Auto] setting.

3 Take the picture.

- The image will be recorded with noise reduction applied.

- With **[Auto]** and **[Enable]**, the noise reduction process after the picture is taken may take the same amount of time as that for the exposure. During noise reduction, shooting is still possible as long as the maximum burst indicator in the viewfinder shows “1” or higher.
- Images taken at ISO 1600 or higher may look grainier with the **[Enable]** setting than with the **[Disable]** or **[Auto]** setting.
- With **[Enable]**, if a long exposure is shot with the Live View image displayed, “**BUSY**” will be displayed during the noise reduction process. The Live View display will not appear until the noise reduction is completed. (You cannot take another picture.)

MENU Highlight Tone Priority

You can reduce overexposed, clipped highlights.

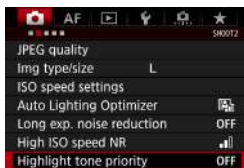

- 1 **Select [Highlight tone priority].**
 - Under the [**2**] tab, select [**Highlight tone priority**], then press <SET>.



- 2 **Select [Enable].**
 - Highlight details are improved. The dynamic range is expanded from the standard 18% gray to bright highlights. The gradation between the grays and highlights becomes smoother.
- 3 **Take the picture.**
 - The image will be recorded with highlight tone priority applied.

- When [**Enable**] is set, noise may increase slightly.
- With [**Enable**], the settable ISO speed range will start from ISO 200. Expanded ISO speeds cannot be set.
- When multiple exposures (p.248) is set, [**Highlight tone priority**] will be automatically switched to [**Disable**].

When highlight tone priority has been set, <**D+**> is displayed in the viewfinder and on the top LCD panel.

MENU Correction of Lens Aberrations

Peripheral light fall-off is a phenomenon that makes the image corners look darker due to the lens characteristics. Color fringing along subject outlines is called chromatic aberration. Image distortion due to lens characteristics is called distortion. And decreased image sharpness due to the aperture is called diffraction phenomenon. These lens aberrations can be corrected. By default, the **[Peripheral illum corr]**, **[Chromatic aberr corr]**, and **[Diffraction correction]** are set to **[Enable]**, and **[Distortion correction]** is set to **[Disable]**.

If the setting screen displays **[Correction data not available]** or the [📷] icon, it means that the correction data for the respective lens is not registered in the camera. See “Lens Correction Data” on page 197.

Peripheral Illumination Correction



1 Select **[Lens aberration correction]**.

- Under the [📷 1] tab, select **[Lens aberration correction]**, then press <SET>.

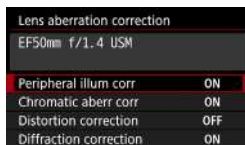

2 Select **[Peripheral illum corr]**.

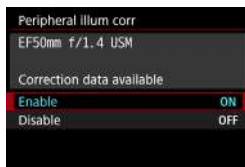

3 Select **[Enable]**.

- Check that **[Correction data available]** is displayed for the attached lens.
- Select **[Enable]**, then press <SET>.

4 Take the picture.

- The image will be recorded with the peripheral illumination corrected.



Depending on shooting conditions, noise may appear on the image periphery.



- The correction amount applied will be lower than the maximum correction amount that can be applied with Digital Photo Professional (EOS software, p.550).
- The higher the ISO speed, the lower the correction amount will be.

Chromatic Aberration Correction



1 Select [**Chromatic aberr corr**].

2 Select [**Enable**].

- Check that [**Correction data available**] is displayed for the attached lens.
- Select [**Enable**], then press <SET>.

3 Take the picture.

- The image will be recorded with the chromatic aberration corrected.

Distortion Correction



1 Select [**Distortion correction**].

2 Select [**Enable**].

- Check that [**Correction data available**] is displayed for the attached lens.
- Select [**Enable**], then press <SET>.

3 Take the picture.

- The image will be recorded with the distortion corrected.

- When distortion correction is enabled, the camera records an image range narrower than the one seen through the viewfinder. (The image periphery is slightly trimmed and the resolution looks slightly lowered.)
- When **[Distortion correction]** is set to **[Enable]**, the maximum burst (p.161) during continuous shooting will decrease.
- During movie shooting, **[Distortion correction]** will not be displayed (correction is not possible).
- If distortion correction is set for Live View shooting, the image corners may look slightly different.
- When you magnify the image during Live View shooting, distortion correction is not applied to the image displayed. Therefore, if the image periphery is magnified, a part of the image range that will not be recorded in the actual image may be displayed.
- Images with distortion correction will not have the Dust Delete Data (p.403) appended. Also, the AF point(s) will not be displayed (p.351) for image playback.

Diffraction Correction

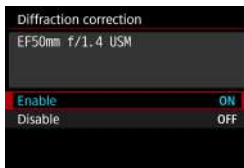

1 Select **[Diffraction correction]**.

2 Select **[Enable]**.

- Select **[Enable]**, then press $\langle \text{SET} \rangle$.

3 Take the picture.

- The image will be recorded with the diffraction corrected.

- Depending on shooting conditions, noise may be intensified with the effects of correction.
- The higher the ISO speed, the lower the correction amount will be.
- For movie shooting, **[Diffraction correction]** will not appear (diffraction correction not possible).

With "Diffraction correction", the deterioration of resolution affected by the low-pass filter, etc. is as well corrected besides the diffraction phenomenon. Therefore, it is effective even at an aperture close to the open aperture.

Lens Correction Data

The lens correction data for lens aberration corrections is registered (stored) in the camera. With **[Enable]** selected, the peripheral illumination, chromatic aberration, distortion, and diffraction will be corrected automatically.

With EOS Utility (EOS software, p.550), you can check which lenses have their correction data registered in the camera. You can also register the correction data for unregistered lenses. For details, refer to the EOS Utility Instruction Manual (p.4).

For lenses incorporating the correction data, it is not necessary to register the correction data to the camera.



Cautions for Lens Correction

- Peripheral illumination correction, chromatic aberration correction, distortion correction, and diffraction correction cannot be applied to JPEG images already taken.
- When using a non-Canon lens, setting the corrections to **[Disable]** is recommended even if **[Correction data available]** is displayed.
- If you use magnified view during Live View shooting, the peripheral illumination correction, chromatic aberration correction, and distortion correction will not be reflected in the image on the screen. Note that the diffraction correction will not be applied to the Live View shooting image.
- The correction amount will be less (except for diffraction correction) if the lens used does not have distance information.



Notes for Lens Correction

- The effect of the lens aberration correction will vary depending on the lens used and shooting conditions. The effect also may be difficult to discern depending on the lens used, shooting conditions, etc.
- If the effect of the correction is not visible, magnify the image after shooting and check it again.
- Corrections can be applied even when an Extender or Life-size Converter is attached.
- If the correction data for the attached lens is not registered to the camera, the result will be the same as when the correction is set to **[Disable]** (except for diffraction correction).



See pages 395 and 396 regarding Digital Lens Optimizer's correction data for when shooting RAW images.

MENU Reducing Flicker

If you shoot an image with a fast shutter speed under a light source such as fluorescent light, the blinking of the light source causes flicker and the image may be vertically unevenly exposed. If continuous shooting is used under these conditions, uneven exposures or colors across the images may result. When you use this feature during viewfinder shooting, the camera detects the frequency of the light source's blinking and takes the picture when the flicker causes less effect on exposure or color tone.

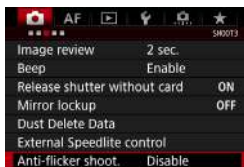

1 Select [Anti-flicker shoot.].

- Under the [**3**] tab, select [**Anti-flicker shoot.**], then press <SET>.

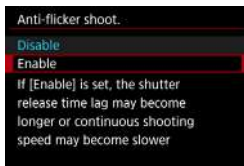

2 Select [Enable].

3 Take the picture.

- The image will be taken with reduced unevenness of exposure or color tone caused by the flicker.

- When [**Enable**] is set and you shoot under a flickering light source, the shutter-release time lag may become longer. Also, the continuous shooting speed may become slower, and the shooting interval may become irregular.
- This function does not work with mirror lockup, Live View shooting, or movie shooting.
- In the <P> or <Av> mode, if the shutter speed changes during continuous shooting or if you shoot multiple shots of the same scene at different shutter speeds, the color tone may be inconsistent. To avoid inconsistent color tones, use the <Tv> or <M> mode at a fixed shutter speed.
- The color tone of images shot when [**Anti-flicker shoot.**] is set to [**Enable**] may look different from when [**Disable**] is set.
- Flicker at a frequency other than 100 Hz or 120 Hz cannot be detected. Also, if the flickering frequency of the light source changes during continuous shooting, effects of the flicker cannot be reduced.



- If the subject is against a dark background or if there is a bright light in the image, flicker may not be properly detected.
- Under certain special types of lighting, the camera may not be able to reduce the effects of the flicker even when < **Flicker!** > is displayed.
- Depending on the light source, flicker may not be detected properly.
- If you recompose a shot, < **Flicker!** > may appear and disappear intermittently.
- Depending on the light sources or shooting conditions, the expected result may not be obtained even if you use this function.



- Taking test shots in advance is recommended.
- If < **Flicker!** > is not displayed in the viewfinder, add a checkmark to **[Flicker detection]** in **[Show/hide in viewfinder]** (p.84). When the camera reduces the effects of the flicker when you shoot, < **Flicker!** > will light up. Under a light source which does not flicker, or if no flicker is detected, < **Flicker!** > will not be displayed.
- If a checkmark is added to **[Flicker detection]** and **[CAMERA 3: Anti-flicker shoot.]** is set to **[Disable]**, metering under a flickering light source will cause < **Flicker!** > to blink in the viewfinder as a warning. Setting **[Enable]** before shooting is recommended.
- Flicker reduction also works with flash. However, the expected result may not be obtained during wireless flash shooting.

MENU Setting the Color Space

The range of reproducible colors is called “color space”. With this camera, you can set the color space for captured images to sRGB or Adobe RGB. For normal shooting, sRGB is recommended.

1 Select [Color space].

- Under the [CAMERA 1] tab, select [Color space], then press <SET>.

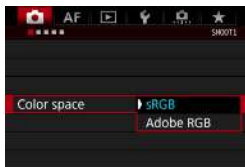

2 Set the desired color space.

- Select [sRGB] or [Adobe RGB], then press <SET>.

Adobe RGB

This color space is mainly used for commercial printing and other industrial uses. This setting is not recommended if you are not familiar with image processing, Adobe RGB, and Design rule for Camera File System 2.0 (Exif 2.21 or higher). The image will look very subdued in a sRGB computer environment and with printers not compliant to Design rule for Camera File System 2.0 (Exif 2.21 or higher). Post-processing of the image with computer software will therefore be required.



- If the captured still photo was shot in the Adobe RGB color space, the first character in the file name will be an underscore “_”.
- The ICC profile is not appended. For explanations about the ICC profile, refer to the Digital Photo Professional Instruction Manual (p.4).

MENU Creating and Selecting a Folder

You can freely create and select the folder where the captured images are to be saved.

This operation is optional since a folder will be created automatically for saving captured images.

Creating a Folder

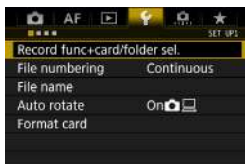

1 Select [Record func+card/folder sel.].

- Under the [**1**] tab, select [**Record func+card/folder sel.**], then press <SET>.



2 Select [Folder].

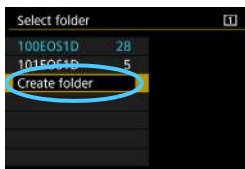

3 Select [Create folder].

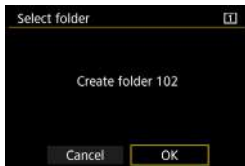

4 Select [OK].

- A new folder with the folder number increased by one is created.

Selecting a Folder

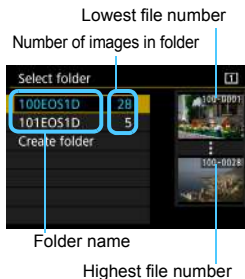

- Select a folder on the folder selection screen, then press <SET>.
- ▶ The folder where the captured images will be saved is selected.
- Subsequently captured images will be recorded into the selected folder.



Folders

As with “100EOS1D” for example, the folder name starts with three digits (the folder number) followed by five alphanumeric characters. A folder can contain up to 9999 images (file number 0001 - 9999). When a folder becomes full, a new folder with the folder number increased by one is created automatically. Also, if manual reset (p.207) is executed, a new folder will be created automatically. Folders numbered from 100 to 999 can be created.

Creating Folders with a Computer

With the card open on the screen, create a new folder named “DCIM”. Open the DCIM folder and create as many folders as necessary to save and organize your images. The folder name must follow the format “100ABC_D”. The first three digits are always the folder number from 100 to 999. The last five characters can be any combination of upper- and lower-case letters from A to Z, numerals, and the underscore “_”. The space cannot be used. Also note that two folder names cannot share the same three-digit folder number (for example, “100ABC_D” and “100W_XYZ”) even if the remaining five characters in each name are different.

MENU Changing the File Name

The file name has four alphanumeric characters followed by a four-digit image number (p.206) and extension. The first four alphanumeric characters are set upon factory shipment and unique to the camera. However, you can change them.

With “User setting1”, you can change and register the four characters as desired. With “User setting2”, if you register three characters, the fourth character from the left will be appended automatically to indicate the image size.

Registering or Changing the File Name

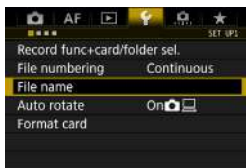

1 Select [File name].

- Under the [**1**] tab, select [**File name**], then press <SET>.



2 Select [Change User setting*].



Character palette

3 Enter any alphanumeric characters.

- For User setting1, enter four characters. For User setting2, enter three characters.
- Press the <[]> button to delete any unnecessary characters.



- Operate the $\langle \text{Left Arrow} \rangle$, $\langle \text{Right Arrow} \rangle$, or $\langle \text{SET} \rangle$ to move the \square and select the desired character. Then press $\langle \text{SET} \rangle$ to enter it.
- To cancel the text entry, press the $\langle \text{INFO} \rangle$ button, then select [OK].

4 Exit the setting.

- After entering the correct number of characters, press the $\langle \text{MENU} \rangle$ button, then select [OK].
- ▶ The registered file name will be saved.



5 Select the registered file name.

- Select [File name], then press $\langle \text{SET} \rangle$.
- Select the registered file name, then press $\langle \text{SET} \rangle$.
- If User setting2 is registered, select “*** (the 3 characters registered) + image size”.

-  The first character cannot be an underscore “_”.

User setting2

When you select the “*** + image size” registered with User setting2 and take pictures, the image size character will be automatically appended as the file name’s fourth character from the left. The meaning of the image-recording quality characters is as follows:

“*** **L**” = L, **RAW**

“*** **M**” = M1, M **RAW**

“*** **N**” = M2

“*** **S**” = S, S **RAW**

When the image is transferred to a computer, you can refer to the fourth character of the image file name to identify the image size without opening the image. RAW or JPEG images can be distinguished with the extension.

- 
 - If you cannot enter text in step 3, press the <Q> button and use the character palette when the blue frame appears.
 - The extension will be “.JPG” for JPEG images, “.CR2” for RAW images, and “.MOV” or “.MP4” for movies.
 - When you shoot a movie with User setting2, the file name’s fourth character will be an underscore “_”.

MENU File Numbering Methods

The captured images are assigned a sequential four-digit file number from 0001 to 9999 and saved in one folder. You can change how the file number is assigned.

(Example) **BE3B0001.JPG**

File numbering

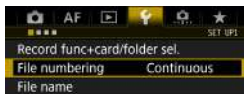

1 Select [File numbering].

- Under the [**1**] tab, select [**File numbering**], then press <SET>.

2 Select the file numbering method.

- Select the desired setting, then press <SET>.



Continuous

Continues the file numbering sequence even after the card is replaced or a new folder is created.

Even after you replace the card, create a folder, or switch the target card (such as [1] → [2]), the file numbering continues in sequence up to 9999 for the images saved. This is useful when you want to save images numbered anywhere between 0001 to 9999 on multiple cards or in multiple folders into one folder on a computer.

If the replacement card or existing folder already contains images recorded previously, the file numbering of the new images may continue from the file numbering of the existing images on the card or in the folder. If you want to use continuous file numbering, it is recommended that you use a newly-formatted card each time.

File numbering after replacing the card

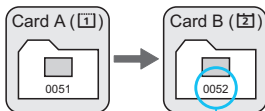

Next sequential file number

File numbering after creating a folder

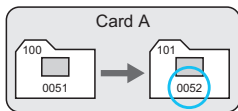

Auto Reset

Restarts the file numbering from 0001 each time the card is replaced or a new folder is created.

When you replace the card, create a folder, or switch the target card (such as [1] → [2]), the file numbering continues in sequence from 0001 for the images saved. This is useful if you want to organize images by cards or folders.

If the replacement card or existing folder already contains images recorded previously, the file numbering of the new images may continue from the file numbering of the existing images on the card or in the folder. If you want to save images with the file numbering starting from 0001, use a newly formatted card each time.

File numbering after replacing the card **File numbering after creating a folder**

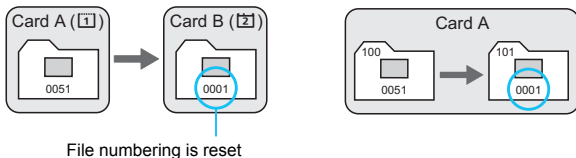

Manual Reset

Resets the file numbering to 0001 or to start from file number 0001 in a new folder.

When you reset the file numbering manually, a new folder is created automatically and the file numbering of images saved to that folder starts, from 0001.

This is useful, for example, if you want to use different folders for the images taken yesterday and the ones taken today. After the manual reset, the file numbering returns to continuous or auto reset. (There will be no manual reset confirmation dialog.)

! If the file number in folder 999 reaches 9999, shooting will not be possible even if the card still has storage capacity. The LCD monitor will display a message telling you to replace the card. Replace it with a new card.

MENU Setting Copyright Information

When you set the copyright information, it will be recorded to the image as Exif information.



1 Select [Copyright information].

- Under the [**4**] tab, select [**Copyright information**], then press <SET>.



2 Select the option to be set.

- Select [**Enter author's name**] or [**Enter copyright details**], then press <SET>.



Character palette

3 Enter text.

- Operate the <⊙>, <☀>, or <☼> to move the and select the desired character. Then press <SET> to enter it.
- You can enter up to 63 characters.
- To delete a character, press the <🗑> button.
- To cancel the text entry, press the <INFO.> button, then select [OK].

4 Exit the setting.

- After entering the text, press the <MENU> button, then select [OK].
- The information is saved.

Checking the Copyright Information



When you select [**Display copyright info.**] in step 2, you can check the [**Author**] and [**Copyright**] information that you entered.

Deleting the Copyright Information

When you select [**Delete copyright information**] in step 2, you can delete the [**Author**] and [**Copyright**] information.

 If the entry for “Author” or “Copyright” is long, it may not be displayed entirely when you select [**Display copyright info.**].

- 
- If you cannot enter text in step 3, press the <Q> button and use the character palette when the blue frame appears.
 - You can also set or check the copyright information with EOS Utility (EOS software, p.550).



4

GPS Settings

This chapter explains the camera's built-in GPS settings. The EOS-1D X Mark II (G) can receive satellite navigation signals from GPS satellites (USA), GLONASS satellites (Russia), and the Quasi-Zenith Satellite System (QZSS) "Michibiki" (Japan).

- The GPS function is set to **[Disable]** by default.
- This manual uses the term "GPS" to refer to the satellite navigation function.

When **[GPS]** is set to **[Mode 1]** (p.215), the camera will continue to receive GPS signals at regular intervals even after the camera's power switch is set to **<OFF>**. The battery will thereby drain faster and the number of possible shots will decrease. If you will not use GPS, setting **[GPS]** to **[Disable]** or **[Mode 2]** is recommended.

 When using GPS function, be sure to check the region of use and use the function in accordance with the laws and regulations of the country or region. Be particularly careful when using GPS outside your home country.

GPS Features

Geotagging Images



- Geotag information^{*1} (latitude, longitude, elevation) and coordinated universal time^{*2} can be appended to images.
- Shooting locations of geotagged images can be displayed on a map on a computer.

*1: Certain travel conditions or GPS settings may cause inaccurate geotag information to be added to images.

*2: Coordinated Universal Time, abbreviated as UTC, is essentially the same as Greenwich Mean Time.

Logging the Route Traveled

You can use the GPS logging function to automatically record the route the camera travels by logging location information at set intervals. The location information for the route the camera has traveled can be viewed on a map displayed on a computer.

* Certain traveling conditions, locations, or GPS settings may cause inaccurate geotag information to be added to images.

Setting the Camera Time

The time information obtained from GPS signals can be set on the camera.

 The GPS information recorded by the images and movies may include information that can personally identify you. Therefore, be careful when giving still photos or movies to other people or displaying them online to the public.

Viewing Images and Information on a Virtual Map

With Map Utility (EOS software, p.550), you can view the shooting locations and the route traveled on a map displayed on a computer.

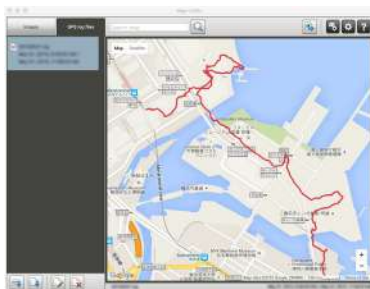

Map data ©2015 ZENRIN

GPS Precautions

■ Countries and Regions Permitting GPS Function Use

Use of GPS function is restricted in some countries and regions, and illegal use may be punishable under national or local regulations. To avoid violating GPS function regulations, visit the Canon website to check where the use is allowed.

Note that Canon cannot be held liable for any problems arising from GPS function use in other countries and regions.

■ Model Number

EOS-1D X Mark II (G) : DS126561

(including GPS module model: ES300)

- In certain countries and regions, the use of GPS function may be restricted. Therefore, be sure to use GPS function in accordance with the laws and regulations of your country or region. Be particularly careful when using GPS function outside your home country.
- Be careful about using GPS function where the operation of electronic devices is restricted.
- Others may be able to locate or identify you by using location data in your geotagged pictures or movies. Be careful when sharing these geotagged images, movies or GPS log files with others, such as when posting them online where many people can view them.
- GPS signal reception may take a longer time in some cases.

Hereby, Canon Inc., declares that this DS126561 is in compliance with the essential requirements and other relevant provisions of Directive 1999/5/EC.

Please contact the following address for the original Declaration of Conformity:

CANON EUROPA N.V.

Bovenkerkerweg 59, 1185 XB Amstelveen, The Netherlands

CANON INC.

30-2, Shimomaruko 3-chome, Ohta-ku, Tokyo 146-8501, Japan



Acquiring GPS Signals

To acquire GPS signals, take the camera outside where the sky is unobstructed. Face the top of the camera toward the sky while keeping your hands, etc., away from the camera top.

When the signal acquisition conditions are good, it will take the camera approx. 30 sec. to 60 sec. to acquire the GPS satellite signals after you set [GPS] to [Mode 1] or [Mode 2]. Check that [GPS] is displayed on the rear LCD panel, then shoot.

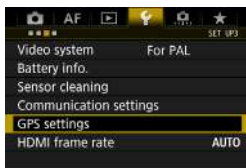

1 Select [GPS settings].

- Under the [**F3**] tab, select [**GPS settings**], then press <SET>.

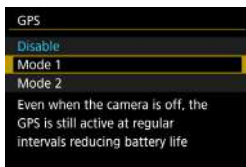

2 Select the mode.

- Select [**Mode 1**] or [**Mode 2**].
- ▶ [**GPS**] will be displayed on the rear LCD panel.

● Mode 1

The camera will continue to receive GPS signals at regular intervals even when the power switch is set to <ON> or <OFF>.

● Mode 2

When the power switch is set to <ON>, the camera will receive GPS signals. When the power switch is set to <OFF>, the GPS function will also turn off. However, if auto power off is in effect, the camera will continue to receive GPS signals at regular intervals.

GPS Acquisition Status



The GPS acquisition status is indicated by the **[GPS]** icon displayed on the camera's rear LCD panel.

Constant **[GPS] : Signal acquired**

Blinking **[GPS] : Signal not acquired yet**

When you shoot while **[GPS]** is constantly displayed, the image will be geotagged.

- !
 When **[Mode 1]** is set, the camera will continue to receive GPS signals at regular intervals even when the power switch is set to **<OFF>**. Therefore, the battery will drain faster and fewer shots can be taken. If you will not use the camera for a prolonged period, set to **[Disable]**.
- When **[Mode 2]** is set, the camera will continue to receive GPS signals at regular intervals even during auto power off. Therefore, if auto power off is prolonged, the battery will drain faster and fewer shots can be taken. If you will not use the camera for a prolonged period, set the power switch to **<OFF>**.
- The GPS antenna is located in front of the hot shoe. The GPS signal can be acquired while an external Speedlite is attached to the hot shoe, but the acquisition sensitivity will slightly decrease.
- GPS Receiver GP-E1 (sold separately) and GP-E2 (sold separately) cannot be used.



Poor GPS Coverage

Under the following conditions, the GPS satellite signal will not be properly acquired. As a result, the geotag information may not be recorded or inaccurate geotag information may be recorded.

- Indoors, underground, in tunnels or forests, between buildings, or in valleys.
- Near high-voltage power lines or mobile phones operating on the 1.5 GHz band.
- When the camera is left inside a bag, etc.
- When traveling a long distance.
- When traveling through different environments.
- Since GPS satellites move as time passes, satellite movement can interfere with geotagging and cause missing or inaccurate geotag information even in conditions other than the above. Additionally, the geotag information may also include the route traveled even if the camera was used at just one location.



- The battery level may be low when you start using the camera due to the effect of the GPS function. If necessary, recharge the battery or prepare a charged, spare battery (sold separately).
- The camera can receive GPS signals even in the vertical orientation.

Viewing GPS Information

- 1 **Check the [GPS] setting.**
 - Check that [GPS] is set to [Mode 1] or [Mode 2].
- 2 **Select [GPS information display].**
 - ▶ The GPS information will be displayed.



- 3 **Take the picture.**
 - When you shoot after GPS signal acquisition, the image will be geotagged.

Generally, elevation is not as accurate as latitude and longitude due to the nature of GPS.

- The <📶,📶,📶> icon indicates signal conditions. When <3D> is displayed, the elevation is also recorded. Note that the elevation cannot be recorded when <2D> is displayed.
- UTC (Coordinated Universal Time) is essentially the same as Greenwich Mean Time.

Geotagging Information

Play back the images and press the <INFO.> button to display the shooting information screen (p.347). Then tilt <📶> up or down to check the geotag information.

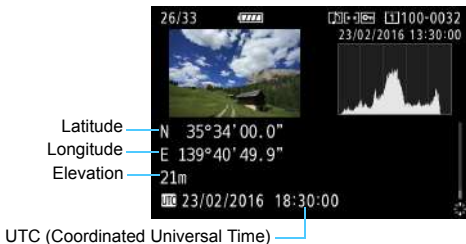

- When you shoot a movie, the GPS information at the time when shooting begins is recorded. Note that signal reception conditions are not recorded.
- Shooting locations can be viewed on a map displayed on a computer, using the Map Utility (EOS software, p.550).

Setting the Positioning Interval

The interval (time) to update the geotag information can be set. Although updating the geotag information at shorter intervals will record more accurate geotag information, it will reduce the number of possible shots because it will drain the battery faster.

1 Check the [GPS] setting.

- Check that [GPS] is set to [Mode 1] or [Mode 2].

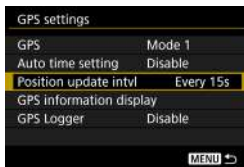

2 Select [Position update intvl].

3 Set the desired update interval.

- Select the desired update interval, then press <SET>.



- If you are in a location where the GPS acquisition condition is not good, the number of possible shots will decrease.
- The nature of GPS may cause some inconsistency in positioning intervals.

Setting Time from GPS on the Camera

The time information obtained from GPS signals can be set in the camera. The margin of error is approx. ± 0.02 sec.

1 Check the [GPS] setting.

- Check that [GPS] is set to [Mode 1] or [Mode 2].

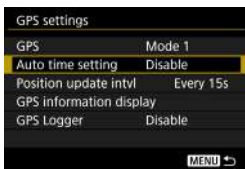

2 Select [Auto time setting].

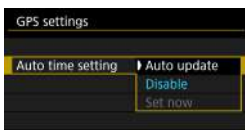

3 Select the desired setting.

- Select [Auto update] or [Set now], then press $\langle \text{SET} \rangle$.
- [Auto update] updates the time when the camera is turned on and a GPS signal is received.



- If signals from at least five GPS satellites cannot be acquired, the time cannot be auto updated. [Set now] will be grayed out and not selectable.
- Even if [Set now] can be selected, updating the time may not be possible due to an unfavorable timing of the GPS signal acquisition.
- When [Auto time setting] is set to [Auto update], the date or time cannot be manually set with [F2: Date/Time/Zone].
- If you use Wireless File Transmitter WFT-E8 (sold separately) or WFT-E6 (sold separately) and do not want to change the time after implementing [Sync time between cameras], set [Auto time setting] to [Disable] in step 2.

Logging the Route Traveled



Map data ©2015 ZENRIN

When using the GPS logging function, the geotag information of the route the camera travels is automatically recorded in the camera's internal memory.

With Map Utility (EOS software, p.550), you can view the shooting locations and the route traveled on a map displayed on a computer.

1 Check the [GPS] setting.

- Check that [GPS] is set to [Mode 1] or [Mode 2].



2 Select [GPS Logger].



3 Set [Log GPS position] to [Enable].

- Select [Log GPS position], then press $\langle \text{SET} \rangle$.
- Select [Enable], then press $\langle \text{SET} \rangle$.
- ▶ [LOG] will be displayed on the rear LCD panel.



- With [GPS] set to [Mode 1], the GPS logging function will continue to work even while the power switch is set to <OFF>.
- When [Mode 2] is set, setting the power switch to <OFF> will also turn off the GPS logging function. However, the GPS logging function will continue to work during auto power off.

Geotag Information Logs

Geotag information for the route the camera travels is recorded at the intervals set with **[Position update intvl]** (p.220). The log data is saved in the camera's internal memory by date. The table below shows how many days' worth of data can be saved.

Log Data Capacity by Positioning Interval (Approx.)

Update Interval	Log Data	Update Interval	Log Data
Every 1 sec.	4.1 days	Every 30 sec.	100 days
Every 5 sec.	20 days	Every 1 min.	100 days
Every 10 sec.	41 days	Every 2 min.	100 days
Every 15 sec.	61 days	Every 5 min.	100 days

* Based on 1 day equivalent to eight hours worth of log data.

- The log data saved in the internal memory can be transferred as a log file to a card (p.224).
- Log file names consist of the date and number (e.g. 16031800). A log file is created for each day. If the time zone changes (p.55), a new log file will be created.
- If the camera's internal memory becomes full, the oldest log data will be erased, and the newest log data will be saved.

Battery Consumption During Logging

When **[GPS]** is set to **[Mode 1]**, the camera will continue to receive GPS signals at regular intervals even after the camera's power switch is set to **<OFF>**. If **[Mode 2]** is set, the camera will continue to receive GPS signals at regular intervals even during auto power off. The battery will thereby drain faster and the number of possible shots will decrease. Additionally, when **[Log GPS position]** is set to **[Enable]**, shorter update intervals will drain the battery more quickly.

When you are not traveling or when GPS signals are weak, setting **[GPS]** to **[Disable]** is recommended.

Downloading Log Data to a Computer

The log data in the camera's internal memory can be downloaded to a computer with EOS Utility (EOS software, p.550) or downloaded from a card after transferring the data to the card.

When you use Map Utility (EOS software, p.550) to open a log file saved on the computer, the camera's travel route will be displayed on a map.

● Importing the log data using EOS software

With the camera connected to a computer via the provided interface cable, you can download the log data to the computer with EOS Utility (EOS software). For details, refer to the EOS Utility Instruction Manual (p.4).

● Transferring the log data to a card for downloading

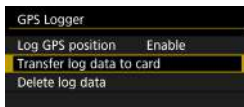

- When [**Transfer log data to card**] is selected, you can transfer the log data in the internal memory as log files to a CF card [**1**] or CFast card [**2**].

Note that when log files are transferred to a card, that log data is erased from the camera's internal memory.



- The log files imported to the card will be stored in the "GPS" folder in the "MISC" folder. The extension is ".LOG".
- Selecting [**Delete log data**] will erase the log data saved in the internal memory. Erasing the data may take approx. one minute.



- When connecting the camera to a computer, use the provided interface cable or one from Canon (p.485). When connecting the interface cable, use the provided cable protector (p.38).
- The GPS antenna is located at the top of the camera body. For this reason, even when carrying the camera, such as in a bag, try to keep the top of the camera facing upwards, and do not place anything on top of it.
- Set the camera time and date as accurately as possible. Also, set correct time zone and daylight saving time for the shooting location.



5

Exposure Control for Photographic Expressions

You can change various settings of the camera as you desire to obtain a wide variety of shooting results, by selecting the shutter speed and/or aperture, adjusting the exposure as you prefer, etc.

- After you press the shutter button halfway and let go, the exposure settings will remain displayed in the viewfinder and on the top LCD panel for approx. 6 sec. (ⓘ6).
- For the functions settable in each shooting mode, see page 486.



Set the power switch to <ON>.

P: Program AE

The camera automatically sets the shutter speed and aperture to suit the subject's brightness. This is called Program AE.

* <P> stands for Program.

* AE stands for Auto Exposure.

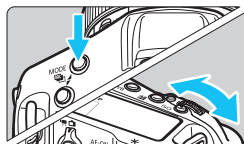

1 Set the shooting mode to <P>.

- Press the <MODE> button and turn the <☀> or <☾> dial to select <P>.



2 Focus on the subject.

- Look through the viewfinder and aim the AF point over the subject. Then press the shutter button halfway.
- ▶ When focus is achieved, the focus indicator <●> on the viewfinder's bottom right will light up (in One-Shot AF mode).
- ▶ The shutter speed and aperture will be set automatically and displayed in the viewfinder and on the top LCD panel.



3 Check the display.

- The standard exposure will be obtained as long as the shutter speed and aperture displays do not blink.

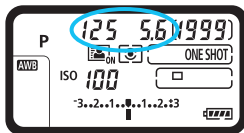

4 Take the picture.

- Compose the shot and press the shutter button completely.





- If the “30” shutter speed and the lowest f/ number blink, it indicates underexposure. Increase the ISO speed or use flash.



- If the “8000” shutter speed and the highest f/ number blink, it indicates overexposure. Lower the ISO speed or use an ND filter (sold separately) to reduce the amount of light entering the lens.



Program Shift

- In the Program AE mode, you can freely change the shutter speed and aperture combination (Program) set automatically by the camera while maintaining the same exposure. This is called Program shift.
- To shift the program, press the shutter button halfway, then turn the  dial until the desired shutter speed or aperture is displayed.
- Program shift will be canceled automatically when the metering timer () ends (exposure setting display turns off).
- Program shift cannot be used with flash.



Minimizing Blurred Photos

- Using Single Silent (p.147), mirror lockup (p.256), or Silent LV shooting (p.281) is effective.
- For continuous shooting, using Silent HS continuous or Silent LS continuous is effective (p.147).
- Use a sturdy tripod that can bear the weight of the shooting equipment. Mount the camera securely on the tripod.
- Using a remote switch is recommended (p.258).

? FAQ

- **The focus indicator <●> blinks and focus is not achieved.**
Aim the Area AF frame over an area having good contrast, then press the shutter button halfway (p.62). If you are too close to the subject, move away and shoot again.
- **Multiple AF points light up simultaneously.**
Focus has been achieved at all those points. You can take the picture as long as an AF point covering the target subject is lighting up.
- **The focus indicator <●> does not light up.**
In the AI Servo AF mode, it indicates that the camera is focusing continuously. (The AF status indicator <AF> is displayed, but the focus indicator <●> does not light.)
Note that focus lock (p.89) will not work in the AI Servo AF mode.
- **Pressing the shutter button halfway does not focus on the subject.**
If the focus mode switch of the lens is set to <MF> (manual focus), set it to <AF> (autofocus).
- **The shutter speed and aperture are blinking.**
Since it is too dark, taking the picture may result in a blurred subject due to camera shake. Using a tripod or a Canon EX-series Speedlite (sold separately, p.260) is recommended.
- **When the external flash was used, the bottom part of the picture came out unnaturally dark.**
If a hood is attached to the lens, it may obstruct the flash light. If the subject is close, detach the hood before taking the picture with flash.

Tv: Shutter-Priority AE

In this mode, you set the shutter speed and the camera automatically sets the aperture to obtain the standard exposure matching the brightness of the subject. This is called shutter-priority AE. A faster shutter speed can freeze the action of a moving subject. A slower shutter speed can create a blurred effect, giving the impression of motion.

* <Tv> stands for Time value.



Blurred motion
(Slow shutter speed: 1/30 sec.)



Frozen motion
(Fast shutter speed: 1/2000 sec.)



1 Set the shooting mode to <Tv>.

- Press the <MODE> button and turn the <MODE> or <DISP/OK> dial to select <Tv>.

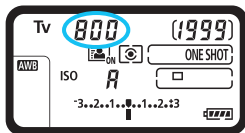

2 Set the desired shutter speed.

- While looking at the top LCD panel, turn the <DISP/OK> dial.





3 Focus on the subject.

- Press the shutter button halfway.
- ▶ The aperture is set automatically.



4 Check the viewfinder display and shoot.

- As long as the aperture is not blinking, the standard exposure will be obtained.

- If the lowest f/number blinks, it indicates underexposure. Turn the dial to set a slower shutter speed until the aperture stops blinking or set a higher ISO speed.
- If the highest f/number blinks, it indicates overexposure. Turn the dial to set a faster shutter speed until the aperture stops blinking or set a lower ISO speed.



Shutter Speed Display

The shutter speeds from “8000” to “4” indicate the denominator of the fractional shutter speed. For example, “125” indicates 1/125 sec., “0”5” indicates 0.5 sec. and “15” is 15 sec.

Av : Aperture-Priority AE

In this mode, you set the desired aperture and the camera sets the shutter speed automatically to obtain the standard exposure matching the subject brightness. This is called aperture-priority AE. A higher *f*/number (smaller aperture hole) will make more of the foreground and background fall within acceptable focus. On the other hand, a lower *f*/number (larger aperture hole) will make less of the foreground and background fall within acceptable focus. * <Av> stands for Aperture value (aperture opening).



Blurred background
(With a low aperture *f*/number: *f*/5.6)



Sharp foreground and background
(With a high aperture *f*/number: *f*/32)



1 Set the shooting mode to <Av>.

- Press the <MODE> button and turn the <MODE> or <DISP> dial to select <Av>.

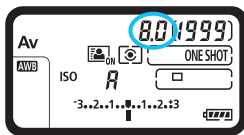

2 Set the desired aperture.

- While looking at the top LCD panel, turn the <MODE> dial.

3 Focus on the subject.

- Press the shutter button halfway.
- ▶ The shutter speed is set automatically.



4 Check the viewfinder display and shoot.

- As long as the shutter speed is not blinking, the standard exposure will be obtained.





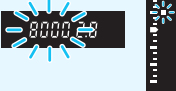

- If the “30” shutter speed blinks, it indicates underexposure. Turn the dial to set a faster aperture (lower f/number) until the shutter speed blinking stops or set a higher ISO speed.
- If the “8000” shutter speed blinks, it indicates overexposure. Turn the dial to set a slower aperture (higher f/number) until the shutter speed blinking stops or set a lower ISO speed.

 **Aperture Value Display**

The higher the f/number, the smaller the aperture opening will be. The f/number displayed will differ depending on the lens. If no lens is attached to the camera, “00” will be displayed for the aperture.

Depth-of-Field Preview

The aperture opening (diaphragm) changes only at the moment when the picture is taken. Otherwise, the aperture remains fully open. Therefore, when you look at the scene through the viewfinder or on the LCD monitor, the depth of field will look narrow.

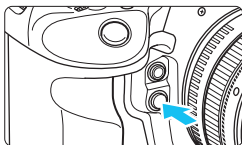

Press the depth-of-field preview button to stop down the lens to the current aperture setting and check the depth of field (range of acceptable focus).



- A higher f/number will make more of the foreground and background fall within acceptable focus. However, the viewfinder will look darker.
- The depth-of-field effect can be clearly seen on the Live View image as you change the aperture and press the depth-of-field preview button (p.272).
- The exposure will be locked (AE lock) while the depth-of-field preview button is being pressed.

M: Manual Exposure

In this mode, you set both the shutter speed and aperture as desired. To determine the exposure, refer to the exposure level indicator in the viewfinder or use a commercially-available exposure meter. This method is called manual exposure.

* <M> stands for Manual.



1 Set the shooting mode to <M>.

- Press the <MODE> button and turn the <☀> or <⊙> dial to select <M>.

2 Set the ISO speed (p.163).

3 Set the shutter speed and aperture.

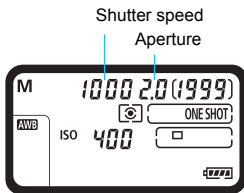

- To set the shutter speed, turn the <☀> dial. To set the aperture, turn the <⊙> dial.
- If you cannot set the shutter speed or aperture, set the power switch to <ON>, then turn the <☀> or <⊙> dial.

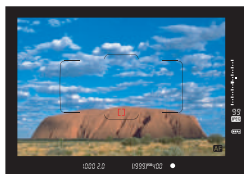

4 Focus on the subject.

- Press the shutter button halfway.
- ▶ The exposure setting will be displayed in the viewfinder and on the top LCD panel.
- Check the exposure level mark <■> on the right of the viewfinder to see how far the current exposure level is from the standard exposure level <■>.

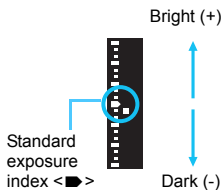

5 Set the exposure and take the picture.

- Check the exposure level indicator and set the desired shutter speed and aperture.
- If the exposure compensation amount exceeds ± 3 stops, the end of the exposure level indicator will display <▲> or <▼>.

Exposure Compensation with ISO Auto

If the ISO speed is set to **A** (AUTO) for manual exposure shooting, you can set exposure compensation (p.241) as follows:

- Under [**6: Custom Controls**], with [**SET: Expo comp (hold btn, turn **)] (p.454).
- Quick Control (p.68)

While looking at the exposure level indicator (setting) on the bottom of the viewfinder or on the top LCD panel, set the exposure compensation amount.



- If ISO Auto is set, the ISO speed setting will change to suit the shutter speed and aperture in order to obtain the standard exposure. Therefore, you may not obtain the desired exposure effect. In such a case, set the exposure compensation.
- If flash is used when ISO Auto is set, exposure compensation will not be applied even if an exposure compensation amount is set.



- Under [**2: Auto Lighting Optimizer**], if the checkmark <√> for [**Disabled in M or B modes**] is removed, Auto Lighting Optimizer can be set even in the <M> mode (p.189).
- When ISO Auto is set, you can press the <✳> button to lock the ISO speed.
- If you press the <✳> button and recompose the shot, you can see the exposure level difference on the exposure level indicator compared with when the <✳> button was pressed.
- If exposure compensation (p.241) was applied in <P>, <Tv>, or <Av> mode, and then the shooting mode is switched to <M> with ISO Auto set, the exposure compensation amount already set will still be maintained.
- With ISO Auto set and [**1: Exposure level increments**] set to [**1/2-stop, Exp. comp. 1/2-stop**], 1/2-stop exposure compensation will be applied with the ISO speed (1/3 stop) and shutter speed. However, the shutter speed displayed will not change.

Selecting the Metering Mode

You can select one of four methods to measure the subject brightness.

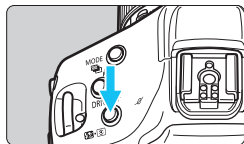



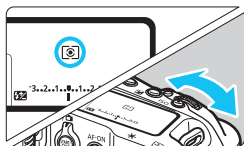

1 Press the  button (ⓘ6).



2 Select the metering mode.

- While looking at the top LCD panel or in the viewfinder, turn the  dial.

- : **Evaluative metering**
- : **Partial metering**
- : **Spot metering**
- : **Center-weighted average metering**

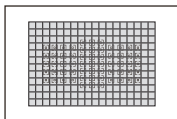

Evaluative metering

General-purpose metering mode suited even for backlit subjects. The camera adjusts the exposure automatically to suit the scene.

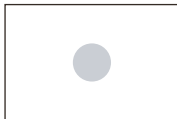

Partial metering

Effective where there are much brighter lights around the subject due to backlight, etc. Partial metering covers approx. 6.2% of the viewfinder area at the center.

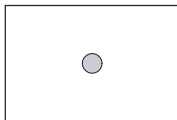

 **Spot metering**



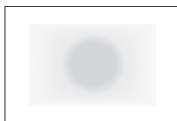



Effective when metering a specific part of the subject or scene. Spot metering covers approx. 1.5% of the viewfinder area at the center. The spot metering circle will be displayed in the viewfinder.



 **Center-weighted average metering**

The metering is averaged for the entire scene with the viewfinder center weighted more heavily.



- With  (Evaluative metering), the exposure setting will be locked when you press the shutter button halfway and focus is achieved (in One-Shot AF mode). In the  (Partial metering),  (Spot metering), and  (Center-weighted average metering) modes, the exposure is set at the moment the picture is taken. (Pressing the shutter button halfway does not lock the exposure.)
- You can set the camera so that  is displayed in the viewfinder when  (Spot metering) is set (p.436).
- If [ 1: Spot meter. linked to AF pt] is set to [Linked to active AF point] (p.423), spot metering linked to all AF points will be possible.

Multi-Spot Metering

With multiple spot meter readings, you can see the relative exposure levels of multiple areas in the picture and decide the final exposure to obtain the desired result.

Multi-spot metering can be used in the <P>, <Tv>, and <Av> modes.

1 Set the metering mode to <[]> (spot metering).

2 Press the <M-Fn> button (Ⓜ16).

- Aim the spot metering circle over the area where you want to check a relative exposure reading, then press the <M-Fn> button. Do this for all the multiple areas you want to meter.
- ▶ On the right of the viewfinder, the relative exposure level will be displayed for the spot meter readings taken. For the exposure, the average of the spot meter readings will be set.



- In this state, you can set the final exposure to achieve the desired photographic expression while comparing the exposure level against the three marks on the exposure level indicator.

- You can take up to eight spot meter readings for one picture.
- The exposure level retained in memory from multi-spot readings will be deleted in the following cases:
 - After the spot metering timer ends (Ⓜ16).
 - You pressed the <MODE>, <DRIVE•AF>, <[]>, <ISO>, <[]>, <[]>, or <WB> button.
- Even when [.. 1: **Spot meter. linked to AF pt**] is set to [Linked to active AF point] (p.423), multi-spot metering can be performed.

⚙️ Setting the Desired Exposure Compensation

Exposure compensation can brighten (increased exposure) or darken (decreased exposure) the standard exposure set by the camera.

Exposure compensation can be set in the <P>, <Tv>, and <Av> shooting modes. Although you can set the exposure compensation up to ± 5 stops in 1/3-stop increments, the exposure compensation indicator in the viewfinder and on the top LCD panel can only display the setting up to ± 3 stops. If the exposure compensation amount will exceed ± 3 stops, set it with the Quick Control (p.68).

If the <M> mode and ISO Auto are both set, see page 237 to set the exposure compensation.

1 Check the exposure.

- Press the shutter button halfway (ⓘ6) and check the exposure level indicator.

Increased exposure for a brighter image

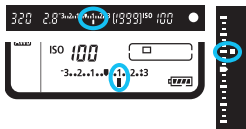

2 Set the exposure compensation amount.



- While looking at the viewfinder or top LCD panel, turn the <ⓘ> dial.
- If you cannot set the exposure compensation, set the power switch to <ON>, then turn the <ⓘ> dial.









Decreased exposure for a darker image



3 Take the picture.

- To cancel exposure compensation, set the exposure level indicator <■/■> back to the standard exposure index (<■>/<■>).

 If [ **2: Auto Lighting Optimizer**] (p.189) is set to any setting other than [**Disable**], the image may still look bright even if a decreased exposure compensation for a darker image is set.

- 
- You can also set it by pressing the  button and turning the  or  dial.
 - The exposure compensation amount will remain in effect even after you set the power switch to **<OFF>**.
 - After setting the exposure compensation amount, you can set the power switch to **<LOCK>** to prevent the exposure compensation amount from changing inadvertently.
 - If the exposure compensation amount exceeds ± 3 stops, the end of the exposure level indicator will display   **>** or   **>**.

Auto Exposure Bracketing (AEB)

By changing the shutter speed or aperture automatically, the camera brackets the exposure up to ± 3 stops in 1/3-stop increments for three successive shots. This is called AEB.

* AEB stands for Auto Exposure Bracketing.

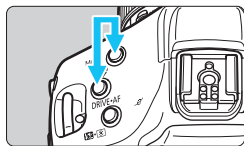



- 1 Hold down the **<MODE>** and **<DRIVE•AF>** buttons simultaneously ().

- ▶ The  and “0.0” will appear on the top LCD panel.



AEB increment

- 2 Set the AEB range.

- Turn the  or  dial to set the AEB range.

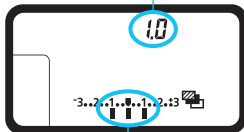

AEB range

- 3 Take the picture.

- Three bracketed shots will be taken according to the drive mode set in this sequence: Standard exposure, decreased exposure, and increased exposure.
- AEB will not be automatically canceled. To cancel AEB, follow step 2 to set the AEB increment to “0.0”.











Standard exposure



Decreased exposure



Increased exposure

-  During AEB shooting, the <✳> icon in the viewfinder and the < > icon on the top LCD panel will blink.
- If the drive mode is set to <□> or <S>, press the shutter button three times for each shot. When < H>, < L>, <S  H>, or <S  L> is set and you hold down the shutter button completely, the three bracketed shots will be taken continuously and the camera will automatically stop shooting. When < 10> or < 2> is set, the three bracketed shots will be taken continuously after an approx. 10-sec. or 2-sec. delay.
- You can set AEB in combination with exposure compensation.
- If the AEB range exceeds ±3 stops, the end of the exposure level indicator will display <▶/▲> or <◀/▼>.
- AEB cannot be used with bulb exposures or flash.
- AEB will be canceled automatically when you set the power switch to <OFF> or when the flash is fully charged.

✳ Lock the Exposure for Shooting (AE Lock)

You can lock the exposure when the area of focus is to be different from the exposure metering area or when you want to take multiple shots at the same exposure setting. Press the <✳> button to lock the exposure, then recompose and take the picture. This is called AE lock. It is effective for shooting backlit subjects, etc.

1 Focus on the subject.

- Press the shutter button halfway.
- ▶ The exposure setting will be displayed.



2 Press the <✳> button (⓪6).



- ▶ The <✳> icon lights up in the viewfinder to indicate that the exposure setting is locked (AE lock).
- Each time you press the <✳> button, the current exposure setting is locked.



3 Recompose and take the picture.

- The exposure level indicator on the right of the viewfinder will show the AE lock exposure level and the current exposure level in real-time.
- If you want to take more pictures while maintaining the AE lock, keep holding down the <✳> button and press the shutter button to take another picture.

AE Lock Effects

Metering Mode (p.238)	AF Point Selection Method (p.93)	
	Automatic Selection	Manual Selection
 *	AE lock is applied at the AF point that achieved focus.	AE lock is applied at the selected AF point.
	AE lock is applied at the center AF point.	

* When the lens's focus mode switch is set to <MF>, AE lock is implemented with the exposure weighting centered on the center AF point.

 AE lock is not possible with bulb exposures.

bulb: Bulb Exposures

In this mode, the shutter stays open as long as you hold down the shutter button completely, and closes when you let go of the shutter button. This photographic technique is called “bulb exposure”. Use bulb exposures for night scenes, fireworks, the heavens, and other subjects requiring long exposures.



1 Set the shooting mode to <buLb>.

- Press the <MODE> button and turn the <☀️> or <🕒> dial to select <buLb>.

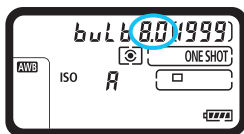

2 Set the desired aperture.

- While looking at the top LCD panel, turn the <☀️> or <🕒> dial.

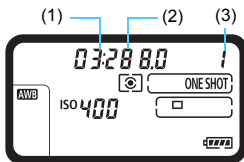

3 Take the picture.

- The exposure will continue for as long as you keep the shutter button pressed completely.
 - ▶ The elapsed exposure time will be displayed on the top LCD panel.
1: min., 2: sec., 3: hour

- ⚠️ Do not point the camera toward an intense light source, such as the sun or an intense artificial light source. Doing so may damage the image sensor or the camera's internal components.
- Long exposures produce more noise than usual.
- If ISO Auto is set, the ISO speed will be ISO 400 (p.165).
- For a bulb exposure, if you use both the self-timer and mirror lockup instead of the bulb timer, keep pressing the shutter button completely (self-timer delay time + bulb exposure time). If you let go of the shutter button during the self-timer countdown, there will be a shutter-release sound, but no picture will be taken.



- With [**📷2: Long exp. noise reduction**], you can reduce the noise generated during long exposures (p.191).
- For bulb exposures, using a tripod and Remote Switch RS-80N3 (sold separately) or Timer Remote Controller TC-80N3 (sold separately) is recommended (p.258).
- Using mirror lockup (p.256) with bulb exposures is also possible.

Multiple Exposures

You can shoot two to nine exposures to be merged into one image. With Live View shooting (p.271), you can see in real time how the exposures are merged when you shoot multiple-exposure images.



1 Select [Multiple exposure].

- Under the [📷1] tab, select [Multiple exposure], then press <ⓈET>.
- ▶ The multiple exposure setting screen will appear.

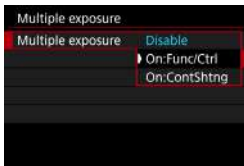

2 Set [Multiple exposure].

- Select [On:Func/Ctrl] or [On:ContShtng], then press <ⓈET>.
- To exit shooting multiple exposures, select [Disable].

● On: Func/Ctrl (Function and control priority)

Useful when you want to shoot multiple exposures while checking the result as you proceed. During continuous shooting, the continuous shooting speed will decrease greatly.

● On: ContShtng (Continuous shooting priority)

Geared for continuous multiple-exposure shooting of a moving subject. Continuous shooting is possible, but the following operations are disabled during shooting: menu viewing, image review after image capture, image playback, and undo last image (p.254). Also, during Live View shooting, the image displayed will not be the final merged image.

Only the multiple-exposure image will be saved. (The single exposures merged in the multiple-exposure image will not be saved.)



3 Set [Multi-expos ctrl].

- Select the desired multiple-exposure control method, then press < (SET) >.

• Additive

The exposure of each single image captured is added cumulatively. Based on the **[No. of exposures]**, set a negative exposure compensation. Follow the basic guide below to set the exposure compensation amount.

Exposure Compensation Setting Guide for Multiple Exposures

Two exposures: -1 stop, three exposures: -1.5 stop, four exposures: -2 stops

• Average

Based on the **[No. of exposures]**, negative exposure compensation is set automatically as you shoot multiple exposures. If you shoot multiple exposures of the same scene, the exposure of the subject's background will be automatically controlled to obtain the standard exposure.

• Bright/Dark

The brightness (or darkness) of the base image and the images to be added are compared at the same position, and then the bright (or dark) part will be left in the picture. Depending on the overlapping colors, the colors may be mixed depending on the brightness (or darkness) ratio between the compared images.



4 Set the [No. of exposures].

- Select the number of exposures, then press < (SET) >.
- You can set it from 2 to 9 exposures.

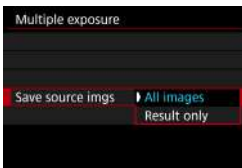

5 Set the images to be saved.

- To save all the single exposures and the merged multiple-exposure image, select **[All images]**, then press $\langle \text{SET} \rangle$.
- To save only the merged multiple-exposure image, select **[Result only]**, then press $\langle \text{SET} \rangle$.

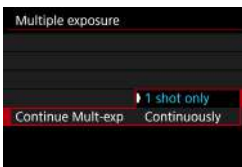

6 Set [Continue Mult-exp].

- Select either **[1 shot only]** or **[Continuously]**, then press $\langle \text{SET} \rangle$.
- With **[1 shot only]**, multiple-exposure shooting will be canceled automatically after the shooting ends.
- With **[Continuously]**, multiple exposure shooting continues until the setting in step 2 is set to **[Disable]**.

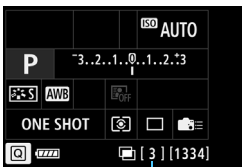

Remaining number of exposures

7 Shoot the first exposure.

- When **[On:Func/Ctrl]** is set, the captured image will be displayed.
- The $\langle \text{CAM} \rangle$ icon will blink.
- You can check the remaining exposures on the right of the viewfinder and in brackets **[]** on the screen.
- Pressing the $\langle \text{VIEW} \rangle$ button enables you to view the captured image (p.254).

8 Shoot subsequent exposures.

- ▶ When [**On:Func/Ctrl**] is set, the merged multiple-exposure image will be displayed.
- Live View shooting with [**On:Func/Ctrl**] set, the multiple-exposure images merged so far will be displayed. By pressing the <INFO.> button, you can display only the Live View image.
- Multiple-exposure shooting will end when the set number of exposures are taken. With continuous shooting, if you keep holding down the shutter button, the shooting continues until the set numbers of exposures are taken.



- When [**On:Func/Ctrl**] is set, you can press the <▶> button to view the multiple exposures taken so far or delete the last single exposure (p.254).
- The shooting information for the last shot will be recorded and appended to the multiple-exposure image.

- The image-recording quality (image size and JPEG quality), ISO speed, Picture Style, high ISO speed noise reduction, and color space, etc. set for the first single exposure will also be set for the subsequent exposures.
- During multiple exposure shooting, the settings of [**1: Lens aberration correction**], [**2: Auto Lighting Optimizer**], and [**2: Highlight tone priority**] will be automatically switched to [**Disable**].
- If [**1: Picture Style**] is set to [**Auto**], [**Standard**] will be applied for shooting.
- With [**On:Func/Ctrl**] and [**Additive**] set, the noise, irregular colors, banding, etc. of the image displayed during shooting may differ from the multiple exposure image recorded in the end.
- With multiple exposures, the more exposures there are, the more noticeable the noise, irregular colors, and banding will be.
- If [**Additive**] is set, the image processing after taking the multiple exposures will take time. (The access lamp will light up longer.)
- If you perform Live View shooting with [**Additive**] set, the Live View function will stop automatically when the multiple-exposure shooting ends.
- In step 8, the brightness and noise of the multiple-exposure image displayed during Live View shooting will be different from the final multiple-exposure image recorded.
- If [**On:ContShtg**] is set, let go of the shutter button after shooting the set number of exposures.
- Doing any of the following will cancel the multiple-exposure shooting: Setting the power switch to <OFF>, replacing the battery, replacing the card, or switching to movie shooting.
- During multiple exposure shooting, [**Clean now** ] or [**Clean manually**] under [**3: Sensor cleaning**] cannot be selected.
- If you switch the shooting mode to <C1>, <C2>, or <C3> during shooting, multiple-exposure shooting will end.
- If you connect the camera to a computer, multiple-exposure shooting will not be possible. If you connect the camera to a computer or printer during shooting, multiple-exposure shooting will end.

Merging Multiple Exposures with an Image Recorded on the Card

You can select a **RAW** image recorded on the card as the first single exposure. The image data of the selected **RAW** image will remain intact. **You can only select RAW images.** You cannot select **M RAW/S RAW** or JPEG images.



1 Select [Select image for multi. expo.].

- ▶ The images on the card will be displayed.

2 Select the first image.

- Turn the <⊙> dial to select the image to be used as the first single exposure, then press <⊙(SET)>.
- Select [OK].
- ▶ The file number of the selected image will be displayed at the bottom of the screen.

3 Take the picture.

- When you select the first image, the number of remaining exposures as set with [No. of exposures] will decrease by 1. For example, if [No. of exposures] is 3, you can shoot two exposures.



- Images shot with [📷2: Highlight tone priority] set to [Enable] and images applied with cropping information (p.439) cannot be selected as the first single exposure.
- [Disable] will be applied for [📷1: Lens aberration correction] and [📷2: Auto Lighting Optimizer] regardless of the settings of the **RAW** image selected as the first single exposure.
- The ISO speed, Picture Style, high ISO speed noise reduction, color space, etc. set for the first **RAW** image will also be applied for the subsequent images.
- If [📷1: Picture Style] is [Auto] for the RAW image selected as the first **RAW** image, [Standard] will be applied for shooting.
- You cannot select an image taken with another camera.

- You can also select a **RAW** multiple-exposure image as the first single exposure.
- If you select [**Deselect img**], the image selection will be canceled.

Checking and Deleting Multiple Exposures During Shooting

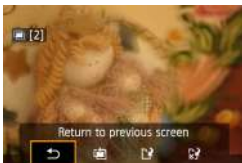

When [**On:Func/Ctrl**] is set and you have not finished shooting the set number of exposures, you can press the <[▶]> button to check the current exposure level, overlap alignment, and overall effect of the merged multiple-exposure image. (Not possible when [**On:ContShrng**] is set.)

If you press the <[⏮]> button, the operations possible during multiple-exposure shooting will be displayed.

Operation	Description
[↶] Undo last image	Deletes the last image you shot (shoot another image). The number of remaining exposures will increase by 1.
[⏮] Save and exit	If [Save source imgs: All images] is set, all of the single exposures and the merged multiple-exposure image will be saved before exiting. If [Save source imgs: Result only] is set, only the multiple-exposure image merged so far will be saved before exiting.
[⏮] Exit without saving	Multiple-exposure shooting will end without saving the images shot.
[↶] Return to previous screen	The screen before you pressed the <[⏮]> button will reappear.

- During multiple-exposure shooting, you can only play back multiple-exposure images.

? FAQ

• Are there any restrictions on the image-recording quality?

All JPEG image-recording quality settings can be selected. If **M RAW** or **S RAW** is set, the merged multiple-exposure image will be saved as a **RAW** image.

Image Size Setting	Single Exposures	Merged Multiple-Exposure
JPEG	JPEG	JPEG
RAW	RAW	RAW
M RAW/S RAW	M RAW/S RAW	RAW
RAW+JPEG	RAW+JPEG	RAW+JPEG
M RAW/S RAW+JPEG	M RAW/S RAW+JPEG	RAW+JPEG

• Can I merge images recorded on the card?

With [**Select image for multi. expo.**], you can select the first single exposure from the images recorded on the card (p.253). Note that you cannot merge multiple images already recorded on the card.

• Are multiple exposures possible with Live View shooting?

You can shoot multiple exposures with Live View shooting (p.271). However, if [**On:ContShtnng**] is set, the captured images will not be displayed as a multiple exposure.

• What file numbers are used for saving merged merged multiple-exposures?

If it is set to save all images, the merged multiple-exposure image file number will be the serial number coming after the file number of the final single exposure used to create the merged multiple-exposure image.

• Will auto power off take effect during multiple-exposure shooting?

As long as [**2: Auto power off**] is set to any setting other than [**Disable**], the power will turn off automatically after 30 min. of idle time. If the auto power off takes effect, multiple-exposure shooting will end, and multiple-exposure settings will be canceled.

Before starting the multiple-exposure shooting, the auto power off will take effect at the time as set with the camera, and multiple-exposure settings will be canceled.

Mirror Lockup

Camera vibrations caused by the mirror's reflex action when the picture is taken is called "mirror shock". Mirror lockup keeps the mirror up before and during exposure to reduce blur caused by camera vibrations. Useful when shooting close-ups (macro photography), using a super telephoto lens, and shooting at slow shutter speeds.



1 Select [Mirror lockup].

- Under the [CAMERA 3] tab, select [Mirror lockup], then press <SET>.

2 Select the desired setting.

- Select [Enable] or [Enable: Mirror down w/SET], then press <SET>.

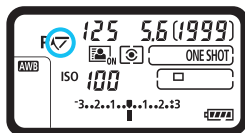

3 Press the shutter button completely.

- Focus on the subject, then press the shutter button completely.
- ▶ The mirror will swing up, and the <Mirror icon> will blink on the top LCD panel.

4 Press the shutter button completely again.

- ▶ The picture will be taken.
- With [Enable] set, the mirror will go back down after the picture is taken.
- With [Enable: Mirror down w/SET] set, the mirror will stay locked up even after shooting. To cancel the mirror lockup, press <SET>.



- Do not point the camera toward an intense light source, such as the sun or an intense artificial light source. Doing so may damage the image sensor or the camera's internal components.
- In very bright light, such as at the beach or a ski slope on a sunny day, take the picture promptly after mirror lockup is stabilized.
- During mirror lockup, shooting function settings and menu operation are disabled.



- When [**Enable**] is set, single shooting will take effect even if the drive mode is set to continuous. When [**Enable: Mirror down w/SET**] is set, the current drive mode will take effect for shooting.
- You can also use the self-timer with mirror lockup.
- If approx. 30 sec. elapse after the mirror has locked up, it will go back down automatically. Pressing the shutter button completely locks up the mirror again.
- When shooting with mirror lockup, using a tripod and Remote Switch RS-80N3 (sold separately) or Timer Remote Controller TC-80N3 (sold separately) is recommended (p.258).

Using the Eyepiece Shutter

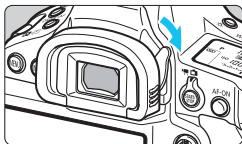

When you take a picture without looking through the viewfinder, such as when you use the self-timer, bulb exposure, or a remote switch, stray light entering the viewfinder can cause the picture to look dark (underexposed). To prevent this, slide the eyepiece shutter lever as shown by the arrow to cover the viewfinder eyepiece.

You do not need to cover the viewfinder eyepiece during Live View shooting or movie shooting.

Using a Remote Switch

You can connect the Remote Switch RS-80N3 (sold separately) or Timer Remote Controller TC-80N3 (sold separately), or any EOS accessory equipped with an N3-type terminal to the camera for shooting (p.485).

To operate the accessory, refer to its Instruction Manual.

1 Open the terminal cover.

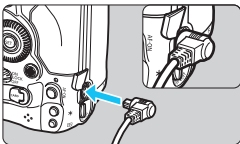

2 Connect the plug to the remote control terminal.

- Connect the plug as shown in the illustration.
- To disconnect the plug, grasp the silver part and pull it out.

6

Flash Photography

This chapter explains how to shoot with external EX-series Speedlites (sold separately) and how to set Speedlite settings on the camera's menu screen.

⚡ Flash Photography

EOS-dedicated, EX-series Speedlites

Using an EX-series Speedlite (sold separately) makes flash photography easy.

For detailed instructions, refer to the EX-series Speedlite's Instruction Manual. This camera is a Type-A camera that can use all the features of EX-series Speedlites.

To set the flash functions and flash Custom Functions on the camera's menu screen, see pages 263-269.



Shoe-mount Speedlites



Macro Lites

- **Flash exposure compensation**

In the same way as normal exposure compensation, flash output can be adjusted. You can set flash exposure compensation up to ± 3 stops in 1/3-stop increments.

Press the camera's $\langle \text{FLASH} \cdot \text{AE-L/AF-ON} \rangle$ button, then turn the $\langle \text{DIAL} \rangle$ dial while looking at the viewfinder or top LCD panel.

- **FE lock**

This enables you to attain an appropriate flash exposure for a specific part of the subject. Aim the viewfinder center over the subject, press the camera's $\langle \text{M-Fn} \rangle$ button, then compose the shot and take the picture.

 If [**2: Auto Lighting Optimizer**] (p.189) is set to any setting other than [**Disable**], the image may still look bright even if a decreased exposure compensation for a darker image is set.

 If it is difficult to achieve focus with autofocus, the EOS-dedicated, external Speedlite will automatically emit the AF-assist beam as necessary.

Canon Speedlites Other Than the EX-series

- With an EZ/E/EG/ML/TL-series Speedlite set to A-TTL or TTL autoflash mode, the flash can be fired at full output only. Set the camera's shooting mode to manual exposure <M> or aperture-priority AE <Av> and adjust the aperture setting before shooting.
- When using a Speedlite that has manual flash mode, shoot in the manual flash mode.

Non-Canon Flash Units

● Sync Speed

The camera can synchronize with non-Canon compact flash units at 1/250 sec. and slower speeds. With large studio flash units, the flash duration is longer than that of a compact flash unit and varies depending on the model. Be sure to check before shooting if flash sync is properly performed by test shooting at a sync speed of approx. 1/60 sec. to 1/30 sec.

● PC Terminal

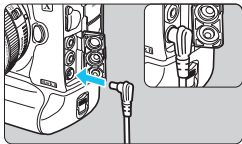

- The camera's PC terminal can be used with flash units having a sync cord. The terminal has locking threads to prevent the cord from falling off.
- The camera's PC terminal has no polarity. You can connect any sync cord regardless of its polarity.

● Cautions for Live View Shooting

If you use a non-Canon flash unit with Live View shooting, set [**5: Silent LV shoot.**] to [**Disable**] (p.281). The flash will not be fired if it is set to [**Mode 1**] or [**Mode 2**].

- If the camera is used with a flash unit or flash accessory dedicated to another camera brand, the camera may not operate properly and malfunction may result.
- Do not connect to the camera's PC terminal any flash unit with an output voltage of 250 V or more.
- Do not attach a high-voltage flash unit to the camera's hot shoe. It may not be fired.

 A flash unit attached to the camera's hot shoe and a flash unit connected to the PC terminal can both be used at the same time.

Metered Manual Flash Exposure

This is for close-up flash photography when you want to set the flash level manually. Use an 18% standard gray card and an EX-series Speedlite that has manual flash mode. Follow the instructions below:

1. Set the camera and flash settings.

- Set the camera's shooting mode to **<M>** or **<Av>**.
- Set the Speedlite to manual flash mode.

2. Focus on the subject.

3. Set up the 18% standard gray card.

- Place the standard gray card at the subject's position.
- Place the standard gray card so that it fills the entire spot metering circle in the viewfinder.

4. Press the **<M-Fn>** button (16).

5. Set the flash exposure level.

- Adjust the Speedlite's manual flash level and the camera aperture so that the flash exposure level aligns with the standard exposure index.

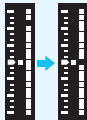

6. Take the picture.

- Remove the standard gray card and take the picture.

MENU Setting the Flash Function

With an EX-series Speedlite having compatible flash function settings, you can use the camera's menu screen to set the Speedlite's functions and Custom Functions. **Attach the Speedlite to the camera and turn on the Speedlite before setting the flash functions.**

For details on the Speedlite's functions, refer to the Speedlite's Instruction Manual.

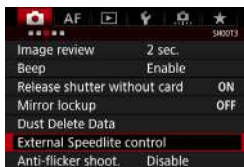

1 Select [External Speedlite control].

- Under the [**3**] tab, select [**External Speedlite control**], then press <SET>.
- ▶ The external Speedlite control screen will appear.

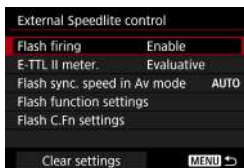

2 Select the desired item.

- Select the menu option to be set, then press <SET>.

Flash Firing



To enable flash photography, set [**Enable**]. To enable only the AF-assist beam to be emitted, set [**Disable**].

E-TTL II Flash Metering



For normal flash exposures, set it to [**Evaluative**]. If [**Average**] is set, the flash exposure will be averaged for the entire metered scene. Depending on the scene, flash exposure compensation may be necessary. This setting is for advanced users.

Flash Sync. Speed in Av Mode

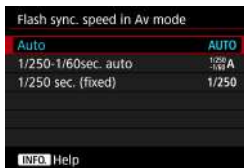

You can set the flash-sync speed for flash photography in the aperture-priority AE <Av> mode.

- **AUTO: Auto**

The flash sync speed is set automatically within a range of 1/250 sec. to 30 sec. to suit the scene's brightness. High-speed sync is also possible.

- **1/250-1/60sec. auto**

Prevents a slow shutter speed from being set in low-light conditions. It is effective for preventing subject blur and camera shake.

However, while the subject will be properly exposed with the flash, the background may come out dark.

- **1/250: 1/250 sec. (fixed)**

The flash sync speed is fixed at 1/250 sec. This more effectively prevents subject blur and camera shake than with [1/250-1/60sec. auto]. However, in low light, the subject's background will come out darker than with [1/250-1/60sec. auto].

ⓘ If [1/250-1/60sec. auto] or [1/250 sec. (fixed)] has been set, high-speed sync is not possible in the <Av> mode.

Flash Function Settings

The screen display and setting options will vary depending on the Speedlite model, current flash mode, Speedlite's Custom Function settings, etc.

For details on the Speedlite's functions, refer to the Speedlite's Instruction Manual.

Sample display

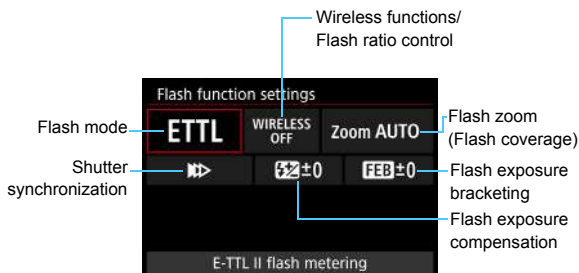

● Flash mode

You can select the flash mode to suit your desired flash shooting.



[E-TTL II flash metering] is the standard mode of EX-series Speedlites for automatic flash shooting.

[Manual flash] is for setting the Speedlite's **[Flash output level]** yourself.

Regarding other flash modes, refer to the Instruction Manual of a Speedlite compatible with the functions.

● Wireless functions / Flash ratio control



Wireless (multiple) flash shooting is possible with radio or optical transmission.

For details on wireless flash, refer to the Instruction Manual of a Speedlite compatible with wireless flash shooting.



With a macro flash (MR-14EX II, etc.) compatible with flash function settings, you can set the flash ratio between flash tubes or flash heads A and B, or use wireless flash with additional slave units. For details on flash ratio control, refer to the macro flash's Instruction Manual.

● Flash zoom (Flash coverage)



With Speedlites having a zooming flash head, you can set the flash coverage.

Normally, set this to **[AUTO]** so that the camera will automatically set the flash coverage to match the lens focal length.

● Shutter synchronization



Normally, set this to [**First-curtain synchronization**] so that the flash fires immediately after the exposure starts.

If [**Second-curtain synchronization**] is set, the flash will be fired right before the shutter closes. When this is combined with a slow shutter speed, you can create a trail of light such as from car headlights at night with a more natural feel. When second-curtain synchronization is set together with [**ETTL II**], the flash will be fired twice in a row: once when you press the shutter button completely and once right before the end of the exposure.

If [**High-speed synchronization**] is set, the flash can be used at all shutter speeds. This is effective when you want to shoot with background blur (open aperture) in locations such as outdoors in daylight.

● Flash exposure compensation



You can set flash exposure compensation up to ± 3 stops in 1/3-stop increments.

For details, refer to the Speedlite's Instruction Manual.

● Flash exposure bracketing



While changing the flash output automatically, three shots will be taken. For details, refer to the Instruction Manual of a Speedlite equipped with flash exposure bracketing.

I When using second-curtain synchronization, set the shutter speed to 1/25 sec. or slower. If the shutter speed is 1/30 sec. or faster, first-curtain synchronization will be applied automatically even if [**Second-curtain synchronization**] is set.

-  • With an EX-series Speedlite not compatible with flash function settings, you can only set the following: [**Flash firing**], [**E-TTL II meter.**], and [**Flash exposure compensation**] under [**Flash function settings**]. ([**Shutter synchronization**] can also be set with certain EX-series Speedlites.)
- If flash exposure compensation is set with the Speedlite, you cannot set the flash exposure compensation with the camera. If it is set with both the camera and Speedlite, the Speedlite's setting overrides the camera's.

Flash Custom Function Settings

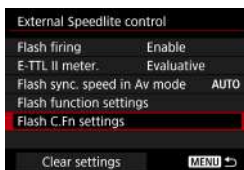

For details on the Speedlite's Custom Functions, refer to the Speedlite's Instruction Manual.



1 Select [**Flash C.Fn settings**].



2 Set the desired functions.

- Select the number, then press <  >.
- Select the setting, then press <  >.

I With an EX-series Speedlite, the Speedlite will always fire at full output if the [**Flash metering mode**] Custom Function is set to [**TTL flash metering**] (autoflash).

Clearing Flash Function Settings / Flash C.Fn Settings

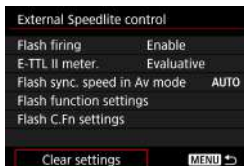

1 Select [Clear settings].

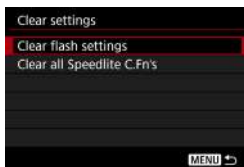

2 Select the settings to be cleared.

- Select [Clear flash settings] or [Clear all Speedlite C.Fn's], then press < (SET) >.
- On the confirmation dialog, select [OK]. Then the flash settings or Custom Function settings will all be cleared.



The Speedlite's Personal Function (P.Fn) cannot be set or canceled on the camera's [External Speedlite control] screen. Set it directly on the Speedlite.



7

Shooting with the LCD Monitor (Live View Shooting)

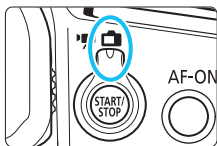

You can shoot while viewing the image on the camera's LCD monitor. This is called "Live View shooting".

Live View shooting is enabled by setting the Live View shooting/Movie shooting switch to .

- If you handhold the camera and shoot while viewing the LCD monitor, camera shake may cause blurred images. Using a tripod is recommended.



Remote Live View Shooting

With EOS Utility (EOS software, p.550) installed on your computer, you can connect the camera to the computer and shoot remotely while viewing the computer screen. For details, refer to the EOS Utility Instruction Manual (p.4).

Shooting with the LCD Monitor

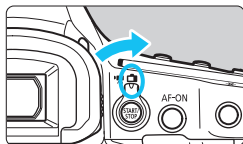

- 1** Set the Live View shooting/Movie shooting switch to .

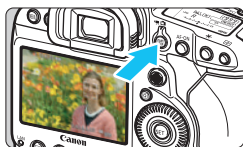



- 2** Display the Live View image.

- Press the  button.
- ▶ The Live View image will appear on the LCD monitor.
- The Live View image will be displayed in the brightness level closely matching that of the actual image to be captured.



- 3** Select the shooting mode.

- Press the  button and turn the  or  dial to select the shooting mode.



- 4** Focus on the subject.

- When you press the shutter button halfway, the camera will focus with the current AF method (p.284).
- You can also tap on the screen to select the face or subject (p.284).

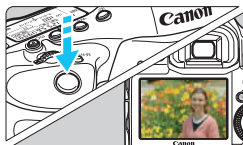

- 5** Take the picture.

- Press the shutter button completely.
- ▶ The picture is taken and the captured image is displayed on the LCD monitor.
- ▶ When the playback display ends, the camera will return to Live View shooting automatically.
- Press the  button to exit the Live View shooting.

Enabling Live View Shooting

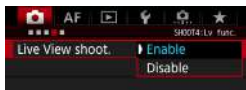

Set [**4: Live View shoot.**] to [**Enable**].

Number of Possible Shots with Live View Shooting

Temperature	Room Temperature (23°C / 73°F)	Low Temperatures (0°C / 32°F)
Possible shots	Approx. 260 shots	Approx. 240 shots

- The figures above are based on a fully-charged Battery Pack LP-E19 and CIPA (Camera & Imaging Products Association) testing standards.
- With a fully-charged Battery Pack LP-E19, the total continuous Live View shooting time will be as follows: At room temperature (23°C/73°F): Approx. 2 hr. 20 min., At low temperatures (0°C/32°F): Approx. 2 hr.

Continuous Shooting Display

With the image size set to JPEG (**L/M1/M2/S**) or **RAW** (except **M RAW** and **S RAW**), continuous shooting during Live View shooting will continuously display (play back) the images captured while you are pressing the shutter button completely. When the continuous shooting ends (shutter button is returned to halfway position), the Live View shooting image will be displayed.

- Continuous shooting during Live View shooting will lock the AF and exposure.
- If you use a Speedlite for Live View shooting and [**High speed continuous**] under [**4: Continuous shooting speed**] is set to [**14 (16) fps**] (p.431), the Speedlite will not be fired during high-speed shooting.

- Do not point the camera toward an intense light source, such as the sun or an intense artificial light source. Doing so may damage the image sensor or the camera's internal components.

- “**General Live View Shooting Cautions**” are on pages 293-294.

- The movie image's field of view is approx. 100% (with movie recording size set to JPEG Large).
- To check the depth of field, press the depth-of-field preview button.
- If you shoot with the recording quality set to **M RAW** or **S RAW**, “**BUSY**” will be displayed and shooting will be disabled temporarily.
- You can also focus by pressing the <AF-ON> button.
- When flash is used, there will be two shutter sounds, but only one shot will be taken. Also, the time it takes to take the picture after you press the shutter button completely will be slightly longer than with viewfinder shooting.
- If the camera is not operated for a prolonged period, the power will turn off automatically after the time set in [**2: Auto power off**] (p.76). If [**2: Auto power off**] is set to [**Disable**], Live View shooting will end automatically after approx. 30 min. (camera power remains on).
- With the HDMI cable HTC-100 (sold separately), you can display the Live View image on a TV set (p.379). Note that no sound will be output. If the picture does not appear on the TV screen, check if the [**3: Video system**] is correctly set to [**For NTSC**] or [**For PAL**] (depending on the video system of your TV set).

Information Display

Each time you press the <INFO.> button, the information display will change.

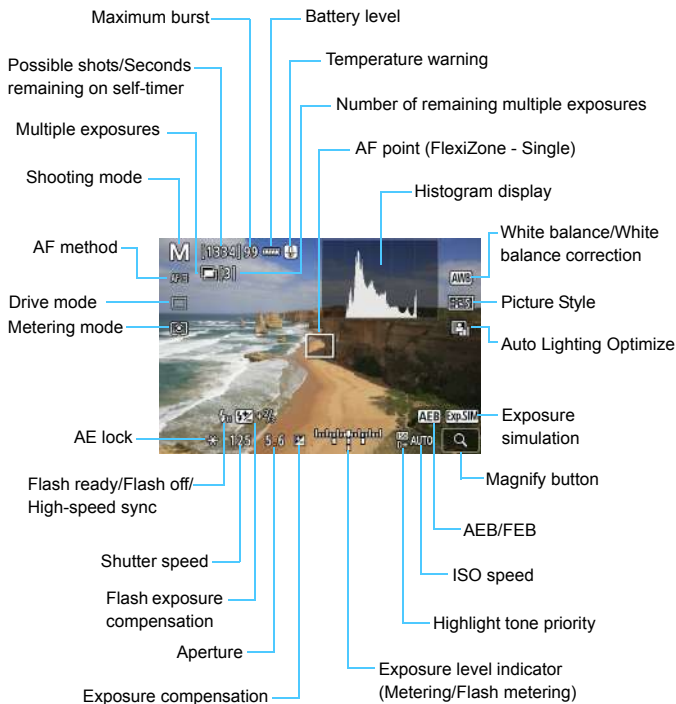



* The display will show only the settings currently applied.

Warnings

Do not hold the camera in the same position for long periods of time.

Even if the camera does not feel too hot, prolonged contact with the same body part may cause skin redness or blistering due to low-temperature contact burns. Using a tripod is recommended for people with circulation problems or very sensitive skin, or when using the camera in very hot places.

-  ● The histogram can be displayed when [4: Expo. simulation] is set to [Enable] (p.281).
- You can display the electronic level by pressing the <INFO.> button (p.82). Note that if the AF method is set to [+Tracking] or if the camera is connected to a TV set with an HDMI cable, the electronic level cannot be displayed.
- When <Exp.SIM> is displayed in white, it indicates that the Live View image is displayed at the brightness level closely matching that of the actual image captured.
- If <Exp.SIM> is blinking, it indicates that the Live View image is displayed at a brightness that differs from the actual shooting result because of low- or bright-light conditions. However, the actual image recorded will reflect the exposure setting. Note that the noise may be more noticeable than the actual image recorded.
- If bulb is set or during flash shooting, exposure simulation is not performed (p.281). <Exp.SIM> icon and histogram will be displayed in gray. The image will be displayed on the LCD monitor at the standard brightness. The histogram may not be properly displayed in low- or bright-light conditions.

Final Image Simulation

Final image simulation is a function that shows the Live View image as it will look with the current settings for Picture Style, white balance, and other shooting functions applied.







The Live View image will automatically reflect the function settings listed below. However, it may be slightly different from the resulting image.

Final Image Simulation During Live View Shooting



- Picture Style
 - * Sharpness (Strength), contrast, color saturation, and color tone will be reflected.
- White balance
- White balance correction
- Metering mode
- Exposure (with [4: Expo. simulation: Enable] set)
- Depth of field (with depth-of-field preview button ON)
- Auto Lighting Optimizer
- Peripheral illumination correction
- Chromatic aberration correction
- Distortion correction
- Highlight tone priority

Shooting Function Settings

MODE/DRIVE/AF//ISO//WB Settings

When the Live View image is displayed, if you press the <MODE>, <DRIVE•AF>, <•>, <>, <ISO>, <>, or <WB> button, the setting screen will appear on the LCD monitor and you can turn the <> or <> dial to set the respective shooting function.

- By pressing the <WB> button and then the <INFO.> button, you can set white balance shift and white balance bracketing.

 When you set  (Partial metering) or  (Spot metering), a metering circle will be displayed at the center of the screen.

Q Quick Control

With the Live View image displayed, you can press the <Q> button to set the AF mode, drive mode, metering mode, white balance, Picture Style, and Auto Lighting Optimizer.



1 Press the <Q> button (10).

- ▶ The settable functions will be displayed.

2 Select a function and set it.

- Use <DISP.> to select a function.
- ▶ The setting of the selected function is displayed on the screen.
- Turn the <DISP.> or <DISP.> dial to set it.
- To set Auto white balance, select [AWB], then press <SET>.
- To set the white balance shift/white balance bracketing or Picture Style parameters, press the <INFO.> button.
- Press <SET> to return to Live View shooting.

MENU Menu Function Settings

📷 4

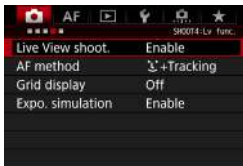

When the Live View shooting/Movie shooting switch is set to <📷>, menu options exclusive to the Live View shooting will appear under the [📷4] and [📷5] tabs.

The settable functions on this menu screen apply only to Live View shooting. They do not work with viewfinder shooting (settings are disabled).

- **Live View shooting**

You can set Live View shooting to **[Enable]** or **[Disable]**.

- **AF method**

You can select **[L+Tracking]** or **[FlexiZone - Single]**. See pages 284-288 for the AF method.

- **Grid display**

With **[3x3 卍]** or **[6x4 卐]**, you can display grid lines to help you level the camera vertically or horizontally. Also, with **[3x3+diag 卐]**, the grid is displayed together with diagonal lines to help you compose with better balance by aligning the intersections over the subject.



● Exposure simulation

Exposure simulation simulates and displays how the brightness (exposure) of the actual image will look.

● Enable (Exp.SIM)

The displayed image brightness will be close to the actual brightness (exposure) of the resulting image. If you set exposure compensation, the image brightness will change accordingly.



● During

Normally, the image is displayed at the standard brightness to make the Live View image easy to see (). The image will be displayed with a brightness (exposure) close to that of the actual image to be captured only while you hold down the depth-of-field preview button ().

● Disable ()

The image is displayed at the standard brightness to make the Live View image easy to see. Even if you set exposure compensation, the image is displayed at the standard brightness.



With [ 2: Highlight tone priority] set to [Disable] and you expand the [Maximum] default ISO speed in [Range for stills] under [ 2: ISO speed settings] (p.166), exposure simulation will become possible under darker conditions.



5



● Silent LV shooting

● Mode 1

Mechanical sound during shooting is suppressed, compared with viewfinder shooting.

You can shoot with any drive mode (p.146). When  is set, if you set [High speed] under [ 4: Continuous shooting speed] to [14 (16) fps] (p.431), you can shoot continuously up to approx. 16.0 fps.



• Mode 2

When the shutter button is pressed completely, only one shot will be taken. While you keep holding down the shutter button, the camera operation will be suspended. Then when you return to the shutter button's halfway position, the camera operation will resume. The release sound at the moment of shooting can thereby be minimized. Even if continuous shooting is set, only a single shot will be taken.

• Disable

Be sure to set it to [**Disable**] if you use a TS-E lens (other than those listed in  below) **for shifting or tilting the lens** or if you use an Extension Tube. If [**Mode 1**] or [**Mode 2**] is set, the standard exposure may not be obtained, or an irregular exposure may result.



- Even if drive mode is set to <S>, <S - Between [**Mode 1**] and [**Disable**], the internal operation alone is different between the single drive mode and the first shot during continuous shooting. Continuous shooting with [**Mode 1**] will have the same mechanical sound as the [**Disable**] setting for the second and subsequent shots.
- With [**Mode 2**] set, continuous shooting will not work even if the drive mode is set to <- If you use flash with the flash mode set to E-TTL II/E-TTL autoflash, shutter release will be performed by the same internal operation mechanism as with viewfinder shooting. Therefore, shooting while suppressing the mechanical sound will not be possible (regardless of the [**Silent LV shoot.**] setting).
- When using a non-Canon flash unit, set it to [**Disable**]. The flash will not be fired if it is set to [**Mode 1**] or [**Mode 2**].
- With H1 (equivalent to ISO 102400) or higher (ISO 32000 or higher if the camera's internal temperature is low), the maximum continuous shooting speed for high-speed continuous shooting during Live View shooting will decrease to approx. 14.0 fps. For details, see page 148.

 With the TS-E17mm f/4L or TS-E24mm f/3.5L II lens, you can use [**Mode 1**] or [**Mode 2**].

● Metering timer

You can change how long the exposure setting is displayed (AE lock time).

● LV touch control

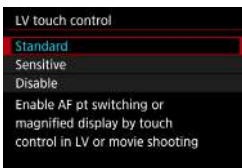

During Live View shooting or movie shooting, you can touch the LCD monitor (touch-sensitive panel called a touchscreen) with your fingers to move the AF point and perform AF, or magnify the image.

[Standard] is the normal setting. [Sensitive] provides a more reactive touchscreen response than [Standard]. Try using both settings and select the one you prefer. To disable touchscreen operations, select [Disable].

🔊 Cautions for Touch Control Operations

- Since the LCD monitor is not pressure sensitive, do not use any sharp objects, such as your fingernail or a ballpoint pen, for touch operations.
- Do not use wet fingers for touchscreen operations.
- If the LCD monitor has any moisture or if your fingers are wet, the touchscreen may not respond or misoperation may occur. In such a case, turn off the power and wipe the LCD monitor with a cloth.
- Attaching any commercially-available protective sheet or sticker on the LCD monitor may make the touchscreen operation response slow.
- If you quickly perform touchscreen operation when [Sensitive] is set, the touchscreen response may be slower.



- No touch shutter is provided (cannot take pictures by touching the screen).
- Selecting any of the items below will cancel Live View shooting. To start Live View shooting again, press the <START/STOP> button.

[📷1: Set Custom WB]: [Record and register WB], [📷3: Dust Delete Data], [👉3: Sensor cleaning], [👉4: Save/load cam settings on card], [👉4: Clear camera settings], [👉4: 📷 firmware ver.]

Focusing with AF (AF Method)

Selecting the AF Method

You can set the AF method to [**L**+Tracking] (p.285) or [**FlexiZone - Single**] (p.287) to suit the shooting conditions or subject.

If you want to achieve precise focus, set the lens's focus mode switch to <MF>, magnify the image, and focus manually (p.291).

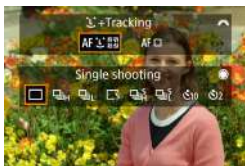

1 Press the <DRIVE•AF> button.

2 Select the AF method.

- Turn the <☀> dial to select the AF method, then press <Ⓢ>.



- You can also set the AF method with the [**4: AF method**] screen.
- Continuous AF is not possible with Live View shooting. (Continuous AF is not provided.)

Touchscreen Operations During AF



If [**5: LV touch control**] is set to [**Standard**] or [**Sensitive**] (p.283), you can tap on the screen where you want to focus to select (to move the AF point) and focus on a person's face or subject.



- This camera does not offer a touch shutter function.
- Regardless of the [**3: Beep**] setting, the beeper (touchscreen beep) will not sound for touchscreen operations. However, when focus is achieved with AF, the beeper (focus confirmation beep) will sound depending on the [**3: Beep**] setting.

☺(face)+Tracking: AF

The camera detects and focuses on human faces. If a face moves, the AF point <☺> also moves to track the face.

1 Display the Live View image.

- Press the <START/STOP> button.
- ▶ The Live View image will appear on the LCD monitor.

**2 Select an AF point.**

- When a face is detected, <☺> will appear over the face to be focused on.
- If multiple faces are detected, <☺☺> will be displayed. Use <☺> to move <☺> over the face you want to focus on.
- You can also tap on the LCD monitor screen to select the face or subject. If you tap on a subject other than a human face, the AF point will be switched to <☺> (p.286).

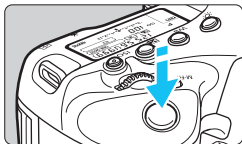
**3 Focus on the subject.**

- Press the shutter button halfway to focus.
- ▶ If no faces can be detected or if you do not tap anything on the screen, the camera will switch to FlexiZone - Single (p.287).
- ▶ When focus is achieved, the AF point will turn green and the beeper will sound.
- ▶ If focus is not achieved, the AF point will turn orange.



4 Take the picture.

- Check the focus and exposure, then press the shutter button completely to take the picture (p.272).

● Focusing on a subject other than a human face

- Tap on the subject (or spot) where you want to focus.
- Press <⊕> or <SET> and the AF point <F ∞> will appear on the screen. Then use <⊕> to move the AF point over the target subject.
- Once the AF point <F ∞> achieves focus, it will track the subject even if the subject moves or if you change the composition.

- If the subject's face is significantly out of focus, face detection will not be possible. Adjust the focus manually (p.291) so that the face can be detected, then perform AF.
- An object other than a human face may be detected as a face.
- Face detection will not work if the face is very small or large in the picture, too bright or too dark, or partially hidden.
- The <⊕> may cover only part of the face.

- Since AF is not possible with a face or a subject detected near the edge of the picture, the <⊕> or <F ∞> will be grayed out. If you press the shutter button halfway in this situation, the subject will be focused on with the FlexiZone - Single method.
- The size of the AF point changes depending on the subject.

FlexiZone - Single: AF □

The camera focuses with a single AF point. This is effective when you want to focus on a particular subject.



AF point

1 Display the Live View image.

- Press the < START/STOP > button.
- ▶ The Live View image will appear on the LCD monitor.
- ▶ The AF point < □ > will appear.
- During movie shooting, if [Movie Servo AF] is set to [Enable], the AF point will be displayed in a larger size.



2 Move the AF point.

- Use < ⬆ > to move the AF point to where you want to focus. (It cannot be moved to the edge of the screen.)
- Using < ⬆ >, < SET >, or the < 🗑 > button will return the AF point to the screen center.
- You can also tap on the LCD monitor screen to move the AF point.

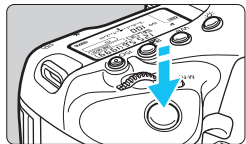

3 Focus on the subject.

- Aim the AF point over the subject and press the shutter button halfway.
- ▶ When focus is achieved, the AF point will turn green and the beeper will sound.
- ▶ If focus is not achieved, the AF point will turn orange.



4 Take the picture.

- Check the focus and exposure, then press the shutter button completely to take the picture (p.272).

Notes for AF

AF Operation

- Even when focus is achieved, pressing the shutter button halfway will focus again.
- The image brightness may change during and after the AF operation.
- If the light source changes while the Live View image is displayed, the screen may flicker and focusing may be difficult. If this happens, exit Live View shooting and perform AF under the actual light source under which you are shooting.



- If you cannot achieve focus with AF, set the lens's focus mode switch to **<MF>** and focus manually (p.291).
- If you shoot the subject at the periphery and it is slightly out of focus, recompose to move the subject (and AF point) toward the screen center, focus again, then take the picture.
- The external Speedlite will not emit the AF-assist beam. However, if an EX-series Speedlite (sold separately) equipped with an LED light is used, the LED light will turn on for AF-assist when necessary.
- With certain lenses, it may take more time to achieve focus with autofocus, or accurate focusing may not be achieved.

Shooting Conditions that Make Focusing Difficult

- Subject with low-contrast such as the blue sky, solid-color flat surfaces or when highlight or shadow details are clipped.
- Subjects in low light.
- Stripes and other patterns where there is contrast only in the horizontal direction.
- Subjects with repetitive patterns (Example: Skyscraper windows, computer keyboards, etc.).
- Fine lines and subject outlines.
- Under a light source whose brightness, color, or pattern keeps changing.
- Night scenes or points of light.
- The image flickers under fluorescent or LED lighting.
- Extremely small subjects.
- Subjects at the edge of the picture.
- Strongly backlit or reflective subjects (Example: Car with a highly reflective body, etc.).
- Near and distant subjects covered by an AF point (Example: Animal in a cage, etc.).
- Subjects that keep moving within the AF point and will not stay still due to camera shake or subject blur.
- A subject approaching or moving away from the camera.
- Performing AF when the subject is very far out of focus.
- Soft focus effect is applied with a soft focus lens.
- A special effect filter is used.
- Noise (dots of light, banding, etc.) appears on the screen during AF.

Magnified View for FlexiZone - Single



In the [**FlexiZone - Single**] mode, either press the <Q> button or tap on [**Q**] displayed on the bottom right of the screen. You can magnify the image by approx. 5x or 10x and check the focus.

- To move the AF point, operate <⊕> or tap on the spot you want to magnify.
- Either press the <Q> button or tap on [**Q**] to magnify the image. Each time you press the <Q> button or tap on [**Q**], the magnification ratio changes.
- At 100% (approx. 1x) magnification, operate <⊕> or tap on the screen to move the magnifying frame. Pressing <⊕>, <SET>, or <⏏> button will return the magnifying frame to the screen center.
- Either press the <Q> button or tap on [**Q**] to magnify the area covered by the magnifying frame.
- When the image is magnified by approx. 5x or 10x, you can change the magnified area by operating <⊕> or tapping on the triangle on the screen top, bottom, left, or right.
- If you press the shutter button halfway, AF will be performed in the magnified view.
- If focusing is difficult in the magnified view, return to the normal view and perform AF.

- Magnified view is not possible with [**⏏+Tracking**].
- If you perform AF in the normal view and then the view is magnified, accurate focus may not be achieved.
- AF speed differs between normal view and magnified view.
- When in magnified view, Movie Servo AF (p.331) will not work.
- In magnified view, images will be displayed without chromatic aberration correction or distortion correction applied.
- During magnified view, achieving focus becomes more difficult due to camera shake. Using a tripod is recommended.

MF: Focusing Manually

You can magnify the image and focus precisely with MF (manual focus).

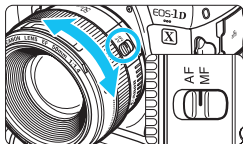

1 Set the lens's focus mode switch to <MF>.

- Turn the lens's focusing ring to focus roughly.

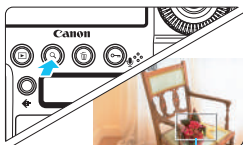

2 Display the magnifying frame.

- Press the <Q> button or tap on [Q] on the screen's lower right.
- ▶ The magnifying frame will appear.

Magnifying frame

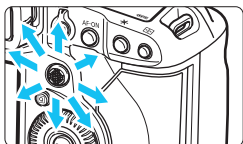

3 Move the magnifying frame.

- Either operate <⬆> or tap on the spot you want to magnify to move the magnifying frame to where you want to focus.
- Pressing <⬆>, <SET>, or <⌫> button will return the magnifying frame to the screen center.



AE lock

Magnified area position

Magnification (Approx.)

4 Magnify the image.

- Each time you press the <Q> button or tap on [Q] on the screen's lower right, the display will change in the following sequence:

→ Normal view → 1x → 5x → 10x →

- While in magnified view, you can operate <⬆> or tap on the directional wedges displayed on the top, bottom, left, or right of the screen to scroll around the magnified image.

5 Focus manually.

- While looking at the magnified image, turn the lens's focusing ring to focus.
- After achieving focus, press the <Q> button to return to the normal view.

6 Take the picture.

- Check the exposure, then press the shutter button completely to take the picture (p.272).

 In magnified view, the exposure is locked. (Shutter speed and aperture will be displayed in red.)



General Live View Shooting Cautions

Image Quality

- When you shoot at high ISO speeds, noise (such as dots of light and banding) may become noticeable.
- Shooting in high temperatures may cause noise and irregular colors in the image.
- If Live View shooting is used continuously for a prolonged period, the camera's internal temperature may rise, and image quality may deteriorate. Always exit Live View shooting when you are not shooting.
- If you shoot a long exposure while the camera's internal temperature is high, image quality may deteriorate. Exit Live View shooting and wait a few minutes before shooting again.

White <[Icon]> and Red <[Icon]> Internal Temperature Warning Icons

- If the camera's internal temperature increases due to prolonged Live View shooting or under a high ambient temperature, a white <[Icon]> or red <[Icon]> icon will appear.
- The white <[Icon]> icon indicates that the image quality of still photos will deteriorate. It is recommended that you temporarily exit Live View shooting and allow the camera to cool down before shooting again.
- The red <[Icon]> icon indicates that the Live View shooting will soon stop automatically. If this happens, you will not be able to shoot again until the camera's internal temperature decreases. Exit the Live View shooting or turn off the power and let the camera rest for a while.
- Using Live View shooting at a high temperature for a prolonged period will cause the <[Icon]> or <[Icon]> icon to appear earlier. When you are not shooting, always turn off the camera.
- If the camera's internal temperature is high, the quality of images shot with a high ISO speed or long exposure may deteriorate even before the white <[Icon]> icon is displayed.

Shooting Results

- In magnified view, the shutter speed and aperture will be displayed in red. If you take the picture in magnified view, the exposure may not come out as desired. Return to the normal view before taking the picture.
- Even if you take the picture in magnified view, the image will be captured with the image area of the normal view.



General Live View Shooting Cautions

Live View Image

- Under low- or bright-light conditions, the Live View image may not reflect the brightness of the captured image.
- Even if a low ISO speed is set, noise may be noticeable in the displayed Live View image under low light. However, when you shoot, the image recorded will have less noise. (The image quality of the Live View image is different from that of the recorded image.)
- If the light source (illumination) within the image changes, the screen may flicker. If this happens, exit Live View shooting and resume Live View shooting under the actual light source.
- If you point the camera in a different direction, it may throw off the Live View image's correct brightness momentarily. Wait until the brightness level stabilizes before shooting.
- If there is a very bright light source in the image, the bright area may appear black on the LCD monitor. However, the actual captured image will correctly show the bright area.
- In low light, if you set the [**F2: LCD brightness**] to a bright setting, noise or irregular colors may appear in the Live View image. However, the noise or irregular colors will not be recorded in the captured image.
- When you magnify the image, the image sharpness may look more pronounced than in the actual image.

Custom Functions

- During Live View shooting, certain Custom Functions will not work (some settings become invalid). For details, see page 418.

Lens and Flash

- If the attached lens has an Image Stabilizer and you set the Image Stabilizer (IS) switch to <ON>, the Image Stabilizer will operate at all times even if you do not press the shutter button halfway. The Image Stabilizer consumes battery power and may decrease the number of possible shots. When the Image Stabilizer is not necessary, such as when using a tripod, it is recommended that you set the IS switch to <OFF>.
- The focus preset function is possible for Live View shooting only when using a (super) telephoto lens equipped with the focus preset mode released in and after the second half of 2011.
- FE lock, modeling flash, and metered manual flash exposure will not work if an external Speedlite is used.

8

Shooting Movies

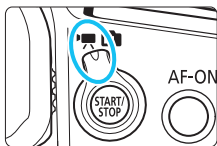

Movie shooting is enabled by setting the Live View shooting/Movie shooting switch to <  >.

- **Before shooting movies, see page 316 and make sure the card is able to record movies at the desired movie-recording quality setting.**
- If you handhold the camera and shoot movies, camera shake can cause blurred movies. Using a tripod is recommended in such cases.



Full HD 1080

Full HD 1080 indicates compatibility with High-Definition featuring 1080 vertical pixels (scanning lines).



Shooting Movies

Autoexposure Shooting

When the shooting mode is set to <P> or <bulb>, autoexposure control will take effect to suit the scene's current brightness. The autoexposure control will be the same for both <P> and <bulb>.

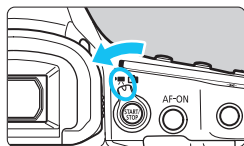

1 Set the Live View shooting/Movie shooting switch to <[icon]>.

- ▶ The image will appear on the LCD monitor.

2 Set the shooting mode to <P> or <bulb>.

- Press the <MODE> button and turn the <[gear]> or <[dial]> dial to select <P> or <bulb>.



3 Focus on the subject.

- Before shooting a movie, focus with AF or manual focus (p.284).
- When you press the shutter button halfway, the camera will focus with the current AF method.

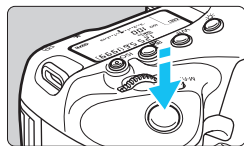

4 Shoot the movie.

- Press the <START/STOP> button to start shooting a movie.
- ▶ While the movie is being shot, the [●] mark will be displayed on the upper right of the screen.
- ▶ Sound will be recorded by the built-in microphone for movie shooting.
- To stop shooting the movie, press the <START/STOP> button again.



Recording movies

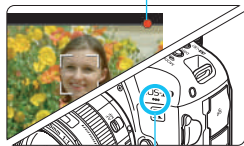

Built-in microphone for movie shooting

Shutter-priority AE

When the shooting mode is <Tv>, you can manually set the shutter speed for movie shooting. The ISO speed and aperture will be set automatically to suit the brightness and obtain the standard exposure.



1 Set the Live View shooting/Movie shooting switch to <Movie>.

2 Set the shooting mode to <Tv>.

- Press the <MODE> button and turn the <Mode dial> or <Shooting mode dial> to select <Tv>.



Shutter speed

3 Set the desired shutter speed.

- While looking at the LCD monitor, turn the <Shutter speed dial>.
- The settable shutter speeds depend on the frame rate. See page 304.



4 Focus and shoot the movie.

- The procedure is the same as steps 3 and 4 for “Autoexposure Shooting” (p.296).



- Changing the shutter speed during movie shooting is not recommended since the changes in the exposure will be recorded.
- When shooting a movie of a moving subject, a shutter speed of 1/25 sec. to 1/125 sec. is recommended. The faster the shutter speed, the smoother the subject's movement will look.
- The minimum shutter speed for shooting movies at a high frame rate will be 1/125 sec. for NTSC and 1/100 sec. for PAL.
- If you change the shutter speed while shooting under fluorescent or LED lighting, image flicker may be recorded.

Av Aperture-priority AE

When the shooting mode is <Av>, you can manually set the aperture for movie shooting. The ISO speed and shutter speed will be set automatically to suit the brightness and obtain the standard exposure.



1 Set the Live View shooting/Movie shooting switch to <[Movie icon]>.

2 Set the shooting mode to <Av>.

- Press the <MODE> button and turn the <[Sun icon]> or <[Sun icon]> dial to select <Av>.



Aperture

3 Set the desired aperture.

- While looking at the LCD monitor, turn the <[Sun icon]> dial.





4 Focus and shoot the movie.

- The procedure is the same as steps 3 and 4 for “Autoexposure Shooting” (p.296).



! Changing the aperture during movie shooting is not recommended since variations in the exposure, due to the drive of the lens aperture, will be recorded.

ISO Speed in the <P>, <Tv>, <Av>, and <bulb> Modes

Full HD movie shooting

- The ISO speed will be set automatically within ISO 100 - ISO 25600.
- Under [2: ISO speed settings], if you set [Range for movies]'s [Maximum] setting to [H2 (204800)] (p.330), the automatic ISO speed setting range's maximum will be expanded to H2 (equivalent to ISO 204800). Even if you set the [Maximum] and [Minimum] to a narrower range than the default ISO range (ISO 100 - ISO 25600), it will not take effect.
- If [2: Highlight tone priority] is set to [Enable] (p.193), the automatic ISO speed setting range will be ISO 200 - ISO 25600.

4K movie shooting

- The ISO speed will be set automatically within ISO 100 - ISO 12800.
- Under [2: ISO speed settings], if you set [Range for ]s [Maximum] setting to [H2 (204800)] (p.330), the automatic ISO speed setting range's maximum will be expanded to H2 (equivalent to ISO 204800). Even if you set the [Maximum] and [Minimum] to a narrower range than the default ISO range (ISO 100 - ISO 12800), it will not take effect.
- If [2: Highlight tone priority] is set to [Enable] (p.193), the automatic ISO speed setting range will be ISO 200 - ISO 12800.



- For movie shooting, the ISO speed cannot be expanded to L (equivalent to ISO 50) or H3 (equivalent to ISO 409600).
- When switching from still photo shooting to movie shooting, check the ISO speed settings again before shooting movies.



Notes for <P><Tv><Av><bulb> Modes

- You can lock the exposure (AE lock) by pressing the <✳> button. After applying AE lock during movie shooting, you can cancel it by pressing the <☒> button. (AE lock setting is retained until you press the <☒> button.)
- If you set the power switch to <ON> and turn the <☉> dial, you can set the exposure compensation up to ± 3 stops.
- In the <P> and <bulb> modes, the ISO speed, shutter speed, and aperture will not be recorded in the movie's Exif information.
- During movie shooting in the <P>, <Tv>, <Av> or <bulb> mode, this camera supports the Speedlite's function to turn on the LED light automatically in low-light conditions. (However, no icon indicating that the LED light is ON is displayed on the information display screen illustrated on page 305.) For details, refer to the EX-series Speedlite's Instruction Manual.

Manual Exposure Shooting

You can manually set the shutter speed, aperture, and ISO speed for movie shooting. Using manual exposure to shoot movies is for advanced users.



1 Set the Live View shooting/Movie shooting switch to <M>.

2 Set the shooting mode to <M>.

- Press the <MODE> button and turn the <☀> or <🕒> dial to select <M>.



3 Set the ISO speed.

- Press the <ISO> button.
- ▶ The ISO speed setting screen will appear on the LCD monitor.
- Turn the <☀> or <🕒> dial to set it.
- For details on the ISO speed, see the next page.

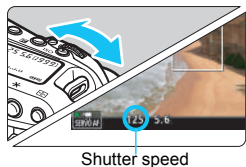

4 Set the shutter speed and aperture.

- Press the shutter button halfway and check the exposure level indicator.
- To set the shutter speed, turn the <☀> dial. To set the aperture, turn the <🕒> dial.
- The settable shutter speeds depend on the frame rate. See page 304.

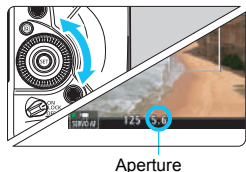

5 Focus and shoot the movie.

- The procedure is the same as steps 3 and 4 for “Autoexposure Shooting” (p.296).

ISO Speed in the <M> Mode

📺: Full HD movie shooting

- With **[AUTO] (A)**, the ISO speed will be set automatically within ISO 100 - ISO 25600. In **[Range for movies]** under **[📷2: ISO speed settings]**, if you set **[Maximum]** to **[H2(204800)]** (p.330), the maximum ISO speed for automatic ISO speed setting range will be expanded to H2 (equivalent to ISO 204800). Even if you set the **[Maximum]** and **[Minimum]** to a narrower range than the default ISO range (ISO 100 - ISO 25600), it will not take effect.
- You can set the ISO speed manually within ISO 100 - ISO 25600 in 1/3-stop increments. If you set **[Maximum]** in **[Range for movies]** to **[H2 (204800)]**, the maximum ISO speed for automatic ISO speed setting range will be expanded to H2 (equivalent to ISO 204800). You can also set the **[Maximum]** and **[Minimum]** to a range narrower than the default range (ISO 100 - ISO 25600).
- If **[📷2: Highlight tone priority]** is set to **[Enable]** (p.193), automatic/manual setting range of ISO speed will be ISO 200 - ISO 25600.











📺: 4K movie shooting

- With **[Auto] (A)**, the ISO speed will be set automatically within ISO 100 - ISO 12800. Under **[📷2: ISO speed settings]** in **[Range for 4K]**, if you set **[Maximum]** to **[H2 (204800)]** (p.330), the maximum ISO speed for automatic ISO speed setting range will be expanded to H2 (equivalent to ISO 204800). Even if you set the **[Maximum]** and **[Minimum]** to a narrower range than the default ISO range (ISO 100 - ISO 12800), it will not take effect.
- You can set the ISO speed manually within ISO 100 - ISO 12800 in 1/3-stop increments. If you set **[Maximum]** in **[Range for 4K]** to **[H2 (204800)]**, the the maximum ISO speed for automatic ISO speed setting range will be expanded to H2 (equivalent to ISO 204800). You can also set the **[Maximum]** and **[Minimum]** to a range narrower than the default range (ISO 100 - ISO 12800).
- If **[📷2: Highlight tone priority]** is set to **[Enable]** (p.193), automatic/manual ISO speed setting range will be ISO 200 - ISO 12800.



- For movie shooting, the ISO speed cannot be expanded to L (equivalent to ISO 50) or H3 (equivalent to ISO 409600).
- When switching from still photo shooting to movie shooting, check the ISO speed settings again before shooting movies.
- During movie shooting, avoid changing the shutter speed or aperture. Doing so may record the changes in the exposure or create more noise at high ISO speeds.
- When shooting a movie of a moving subject, a shutter speed of 1/25 sec. to 1/125 sec. is recommended. The faster the shutter speed, the less smooth the subject's movement will look.
- The minimum shutter speed for shooting movies at a high frame rate will be 1/125 sec. for NTSC and 1/100 sec. for PAL.
- If you change the shutter speed while shooting under fluorescent or LED lighting, image flicker may be recorded.



- In step 4, if you cannot set the shutter speed or aperture, set the power switch to <ON> and turn the < > or < > dial.
- Under [ 6: Custom Controls], if [ SET: Expo comp (hold btn, turn )] is set (p.454), you can set exposure compensation while ISO Auto is set.
- When ISO Auto is set, you can press the < > button to lock the ISO speed. After locking the ISO speed during movie shooting, you can cancel it by pressing the < > button. (ISO speed lock is maintained until you press the < > button.)
- If you press the < > button and recompose the shot, you can see the exposure level difference on the exposure level indicator (p.305) compared to when the < > button was pressed.
- By pressing the <INFO.> button when the camera is ready to shoot, you can display the histogram.

Settable Shutter Speeds

The settable shutter speeds in the <Tv> shutter-priority AE and <M> manual-exposure shooting modes vary depending on the frame rate of the movie-recording quality.

Frame rate	Settable Shutter Speeds
119.9P	1/4000 - 1/125 sec.
100.0P	1/4000 - 1/100 sec.
59.94P	1/4000 - 1/60 sec.
50.00P	1/4000 - 1/50 sec.
29.97P	1/4000 - 1/30 sec.
25.00P 24.00P 23.98P	1/4000 - 1/25 sec.

Still Photo Shooting

Still photos cannot be taken during movie shooting. To take still photos, stop the movie shooting and take still photos using viewfinder shooting or Live View shooting.

Information Display

Each time you press the <INFO.> button, the information display will change.

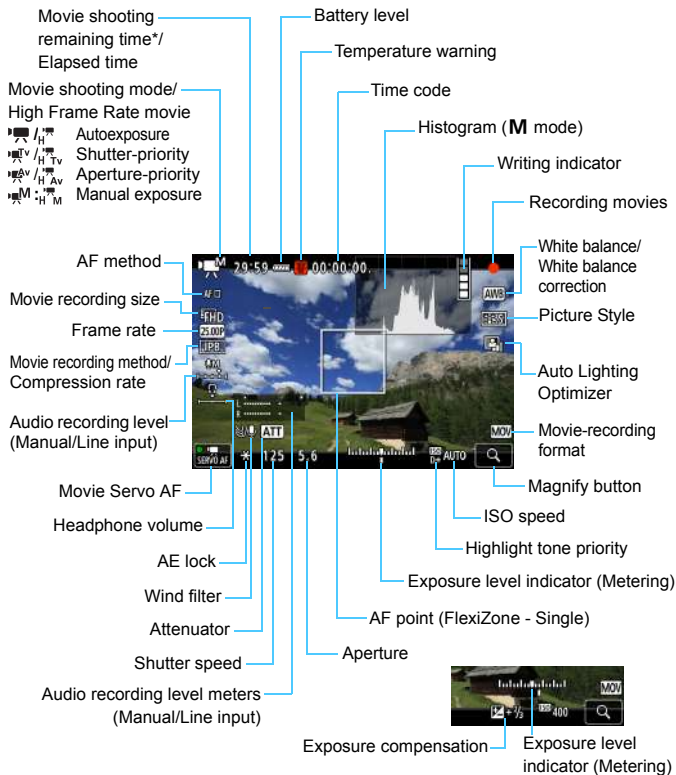

* Applies to a single movie clip.

- The display will show only the settings currently applied.



- When **[AF method]** is **[FlexiZone - Single]**, you can press the **<INFO.>** button to display the electronic level (p.82).
- Note that if **[AF method]** is set to **[L+Tracking]** or if the camera is connected to a TV set with an HDMI cable, the electronic level will not be displayed.
- The electronic level, grid lines, or histogram cannot be displayed during movie shooting. (The display will disappear when you start shooting a movie.)
- When movie shooting starts, the movie shooting remaining time will change to the elapsed time.



Cautions for Movie Shooting

- Do not point the camera toward an intense light source, such as the sun or an intense artificial light source. Doing so may damage the image sensor or the camera's internal components.
- If you shoot something that has fine detail, moire or false colors may result.
- Even if **[Record func.]** is set to **[Rec. to multiple]** under **[F1: Record func+card/folder sel.]** (p.153), the movie cannot be recorded to both the CF card **[L1]** and CFast card **[L2]**. If **[Rec. separately]** or **[Rec. to multiple]** is set, the movie will be recorded to the card which is set for **[Playback]**.
- If **<AWB>** or **<AWB w>** is set and the ISO speed or aperture changes during movie shooting, the white balance may also change.
- If you shoot a movie under fluorescent or LED lighting, the movie image may flicker.
- If you perform AF with a USM lens during movie shooting in low light, horizontal banding noise may be recorded in the movie. The same type of noise may occur if you focus manually with certain lenses equipped with an electronic focus ring.
- Shooting a few test movies is recommended if you intend to perform zooming during movie shooting. Zooming during movie shooting may result in recording of changes in exposure or mechanical sound of the lens, or images may be out of focus.
- During movie shooting, if you perform AF, any of the following may occur: The focus is temporarily greatly thrown off, changes in movie brightness is recorded, the movie recording stops momentarily, and the mechanical sound of the lens is recorded.
- During movie shooting, you cannot magnify the image even if you press the **<Q>** button.
- Be careful not to cover the built-in microphone (p.296) with your fingers, etc.
- If you connect or disconnect the HDMI cable during movie shooting, the movie shooting will end.

Warnings

Do not hold the camera in the same position for long periods of time.











Even if the camera does not feel too hot, prolonged contact with the same body part may cause skin redness or blistering due to low-temperature contact burns. Using a tripod is recommended for people with circulation problems or very sensitive skin, or when using the camera in very hot places.



- “General Movie Shooting Cautions” are on pages 341-342.
- If necessary, also read “General Live View Shooting Cautions” on pages 293-294.



Notes for Movie Shooting

- Movie-related settings are under the [ 4] and [ 5] tabs (p.331).
- Each time you shoot a movie, a new movie file is created on the card.
- The movie screen coverage for 4K movies is approx. 100% and for Full HD, approx. 100%.
- You can also focus by pressing the <AF-ON> button.
- Under [ 5:  btn function], if [ AF / ] or [ / ] is selected, you can press the shutter button completely to start or stop the movie shooting (p.337).
- Monaural sound is recorded by the camera’s built-in microphone (p.296).
- Most external microphones equipped with a 3.5 mm diameter mini plug can be used.
- With a fully-charged Battery Pack LP-E19, the total movie shooting time will be as follows: At room temperature (23°C/73°F), approx. 2 hr. 20 min., at low temperatures (0°C/32°F) approx. 2 hr. (With [ 4: **Movie Servo AF: Disable**] and  FPS 29.97P / 25.00P / 24.00P / 23.98P [TPB] set.)
- The focus preset function is possible for movie shooting when using a (super) telephoto lens equipped with the focus preset mode, released in and after the second half of 2011.

Final Image Simulation

Final image simulation is a function that shows the movie as it will look with the current settings for Picture Style, white balance and other shooting functions applied.



During movie shooting, the image displayed will automatically show the effects of the settings listed below.

Final Image Simulation for Movie Shooting

- Picture Style
 - * Sharpness (Strength), contrast, color saturation, and color tone will be reflected.
- White balance
- White balance correction
- Exposure
- Depth of field
- Auto Lighting Optimizer
- Peripheral illumination correction
- Chromatic aberration correction
- Highlight tone priority

Shooting Function Settings

MODE/AF/ISO//WB Settings

If you press the <MODE>, <DRIVE•AF>, <ISO>, <>, or <WB> button with the image displayed on the LCD monitor, the setting screen will appear on the LCD monitor and you can turn the <> or <> dial to set the respective function.

- During manual exposure shooting (p.301), you can press the <ISO> button to set the ISO speed. For details on setting the ISO speed, see page 302.
- By pressing the <WB> button and then the <INFO.> button, you can set white balance shift and white balance bracketing.
- Note that the drive mode, metering mode, and flash exposure compensation cannot be set.

Q Quick Control

While the image is displayed on the LCD monitor, you can press the <Q> button and set the following: AF method, movie-recording size, sound-recording level (with Manual/Line input), headphone volume, white balance, Picture Style, and Auto Lighting Optimizer.



1 Press the <Q> button (10).

- ▶ The settable functions will be displayed.

2 Select a function and set it.

- Use <DISP> to select a function.
- ▶ The setting of the selected function is displayed on the screen.
- Turn the <W/B> or <DISP> dial to set it.
- To set the movie-recording size, press <SET>.
- To set Auto white balance, select [AWB], then press <SET>.
- To set the white balance shift or Picture Style parameters, press the <INFO.> button.
- Pressing <SET> will return the camera to movie shooting.

Under [4: Movie rec quality], if [High Frame Rate] is set to [Enable], the sound-recording level option will not be displayed. Also, the movie-recording size cannot be set.

MENU Setting the Movie Recording Quality



With [**4: Movie rec quality**], you can set the movie-recording format, movie-recording size (movie size, frame rate, movie-recording format, compression rate), and other functions.

The frame rate displayed on the [**Movie rec. size**] screen switches automatically depending on the [**3: Video system**] setting (p.497).

The card's writing and reading speeds required for recording movies will differ depending on the movie-recording quality. Before shooting movies, see page 316 to check the performance requirements of the card.

MOV/MP4

You can select the movie's recording format.



MOV MOV

The movie will be recorded in the MOV format (file extension “.MOV”). Convenient for editing with a computer.

MP4 MP4

The movie will be recorded in the MP4 format (file extension “.MP4”). This file format is compatible with a much larger range of playback systems than with MOV files.

When [MP4] is set, [High Frame Rate] cannot be set.

Movie Recording Size

You can select the movie's size, frame rate, and compression method.



● Image Size

4K 4096x2160

The movie will be recorded in 4K quality. The aspect ratio is approx.

17:9. When shooting **4K 59.94P /**

50.00P [MJPEG] movies, use a CFast card.

FHD 1920x1080

The movie will be recorded in Full High-Definition (Full HD) quality.

The aspect ratio is 16:9.

● Frame Rate (fps:frame per second)

119.9P 119.9fps / 59.94P 59.94fps / 29.97P 29.97fps

For areas where the TV system is NTSC (North America, Japan, South Korea, Mexico, etc.). For **119.9P**, see page 318.

100.0P 100.0fps / 50.00P 50.00fps / 25.00P 25.00fps

For areas where the TV system is PAL (Europe, Russia, China, Australia, etc.). For **100.0P**, see page 318.

23.98P 23.98fps / 24.00P 24.00fps

Mainly for motion pictures. For **24.00P**, see page 317.

 **23.98P** (23.98fps) can be selected when [**3: Video system**] is set to [**For NTSC**].

● 4K movie shooting

- Shooting 4K movies requires a high-performance card. When shooting **4K 59.94P / 50.00P** movies, use a CFast card. For details on card requirements for movie shooting, see “Cards that Can Record Movies” on page 316.
- Shooting 4K movies or movies at a high frame rate greatly increases the processing load. Compared with normal movie shooting, the camera’s internal temperature may increase faster or may become higher. If the red **Hi** icon appears during movie shooting, it indicates that the card may be hot. Stop the movie shooting and let the camera cool down before removing the card. (Do not remove the card right away.)
- From a 4K movie, you can select any desired frame to save it as an approx. 8.8 megapixel (4096x2160) JPEG still image to the card (p.374).



To obtain better performance with the card, formatting the card with the camera before shooting movies is recommended (p.74).

● Movie-recording coverage

The respective area of the image sensor shown below is used for 4K movies and Full HD movies.

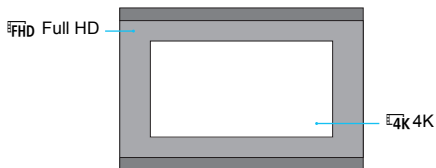

- For 4K movie shooting, [📷2: High ISO speed NR] will not take effect. Therefore, noise may be more noticeable depending on the shooting conditions.
- If you change the [📷3: Video system] setting, also set the movie-recording size again.
- Movies shot in 4K, at a high frame rate, or in [FHD 59.94P / 50.00P] may not be played back properly on other devices due to the heavy data processing load during playback.
- Movies may look different in quality and noise depending on the frame rate setting even if both are in Full HD.
- A movie shot in [4K 59.94P / 50.00P] will be played back on the LCD monitor at a different frame rate from the frame rate of the movie shot.

- The frame rate displayed on the movie recording size screen switches depending on whether [📷3: Video system] is set to [For NTSC] or [For PAL].
- The camera cannot shoot High Definition (HD) and Standard Definition (VGA) movies.
- If you change the movie size from Full HD to 4K, the image area of the movie shooting will be slightly shifted to the telephoto end.
- The 4K movie coverage is different from that of the EOS-1D C.
- The color sampling recorded will be as follows: 4K: YCbCr 4:2:2(8-bit), Full HD: YCbCr4:2:0 (8-bit). The color matrix will be as follows: 4K: Rec. ITU-R BT.601, Full HD: Rec. ITU-R BT.709.

● Movie recording method/Compression rate

MJPG

Selectable when the movie recording format is **[MOV]**. Motion JPEG is used to compress the movie for recording. Without any compression between frames, each frame is compressed at a time and recorded. The compression rate is therefore low. Also, since the image size is large with 4K quality, the file size will be large.

ALL-I (For editing/I-only)

Selectable when the movie recording format is **[MOV]**. Compresses each frame at a time for recording. Although the file size is larger than with IPB (Standard), the movie is better suited in editing.

IPB (Standard)

Compresses multiple frames at a time efficiently for recording. Since the file size is smaller than with ALL-I (For editing), movie shooting time will be longer (with a card of the same capacity).

IPB (Light)

Selectable when the movie recording format is **[MP4]**. Since the movie is recorded at a bit rate lower than with IPB (Standard), the file size will be smaller than with IPB (Standard) and the playback compatibility will be higher. Of the four movie-recording methods, this one provides the longest possible shooting time (with a card of the same capacity).

Cards that Can Record Movies

When shooting movies, use a large-capacity card with a reading/writing speed (required card performance) shown in the table or higher than the standard specification. Test the card by taking a few movies in the desired quality (p.311) and make sure the card can properly record the movie.

Movie Recording Quality			CF Card	CFast Card
4K	59.94P 50.00P	[MJPEG]	–	CFast 2.0
	29.97P 25.00P 24.00P 23.98P	[MJPEG]	UDMA 7 100 MB/sec. or faster	CFast 2.0
FHD	119.9P 100.0P	[ALL-I]	UDMA 7 100 MB/sec. or faster	CFast 2.0
	59.94P 50.00P	[ALL-I]	UDMA 7 60 MB/sec. or faster	CFast 2.0
	59.94P 50.00P	[IPB]	30 MB/sec. or faster	
	29.97P 25.00P 24.00P 23.98P	[ALL-I]	30 MB/sec. or faster	
	29.97P 25.00P 24.00P 23.98P	[IPB]	10 MB/sec. or faster	
	29.97P 25.00P	[IPB]	10 MB/sec. or faster	

● Shooting in 4K 59.94p/50.00p

When shooting 4K 59.94P/50.00P [MJPEG] movies, use a CFast card ([Z]). Even with a high-speed CF card, only for an extremely short period of time can be recorded at one time (a maximum of approx. 10 sec.). (Movie shooting stops automatically.)

- If you use a slow-writing card when shooting movies, the movie may not be recorded properly. Also, if you play back a movie on a card with a slow reading speed, the movie may not play back properly.
- To check the card's reading/writing speed, refer to the card manufacturer's website.
- For bit rates, see page 530.



- To optimize the use of the card, formatting the card with the camera before shooting movies is recommended (p.74).
- When movies cannot be recorded normally, format the card and try again. If formatting the card does not resolve the problem, refer to the card manufacturer's website.

24.00p

Records the movie at a frame rate of 24.00 fps.

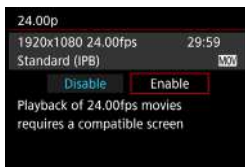

When **[Enable]** is set, you can select the movie-recording quality as follows:

[4K 24.00P [MJPEG], **[FHD 24.00P [ALL-]]**, or
[FHD 24.00P [IPB]].

If you have set **[Movie rec. size]** and then set **[24.00p]** to **[Enable]**, set the **[Movie rec. size]** again.



Cautions for [24.00p: Enable]

- When **[MP4]** is set, **[Movie rec. size]** cannot be set. **[FHD 24.00P [IPB]]** will be set.
- **[High Frame Rate]** (p.318) cannot be set.
- **[⚡3: Video system]** cannot be set.
- **[⚡3: HDMI frame rate]** (p.340) cannot be set. The movie image will be output at 1080/24.00p via HDMI. If you connect the camera to a TV set etc. not compatible with the 1080/24.00p signal via HDMI, the movie image may not be displayed.
- If you set it back to **[Disable]**, **[⚡3: HDMI frame rate]** will be set to **[Auto]**.
- Even if you set it back to **[Disable]**, the movie recording size will not revert to the original setting. Set the movie recording size again.

High Frame Rate

At Full HD quality, you can shoot movies at a high frame rate of 119.9 fps or 100.0 fps. Good for shooting movies to be played back in slow motion. The maximum recording time of one movie clip is 7 min. 29 sec.



Images are recorded in **FHD 119.9P ALL-I MOV** or **FHD 100.0P ALL-I MOV** quality.

High Frame Rate movies do not record sound.

If the time code is displayed during movie shooting, it will count up 4 sec. for each sec. in real time.

Since the High Frame Rate movie will be recorded as a 29.97 fps/25.00 fps movie file, it will be played back in slow motion at 1/4 speed.

Cautions for [High Frame Rate: Enable]

- Under [**5: Time code**], if [**Count up**] is set to [**Free run**] (p.326), the time code will not be recorded.
- [**MOV/MP4**], [**Movie rec. size**], and [**24.00p**] cannot be set.
- Even if you set it back to [**Disable**], the movie recording size will not revert to the original setting. Set the movie recording size again.
- If you shoot a High Frame Rate movie under fluorescent or LED lighting, the movie image may flicker.
- A movie shot at a high frame rate will be played back at a different frame rate on the LCD monitor from the frame rate of the movie shot.
- Headphones cannot be used. (You cannot listen to the sound.)

Total Movie Recording Time and File Size Per Minute

● In MOV Format (Approx.)

Movie Recording Quality	Total Recording Time on Card			File Size	
	4 GB	16 GB	64 GB		
4K : 4K					
59.94P 50.00P	[MPG]	39 sec.	2 min.	10 min.	5733 MB/min.
29.97P 25.00P 24.00P 23.98P	[MPG]	1 min.	4 min.	17 min.	3587 MB/min.
FHD : Full HD					
119.9P 100.0P	[ALL-I]	1 min.	5 min.	23 min.	2585 MB/min.
59.94P 50.00P	[ALL-I]	2 min.	11 min.	47 min.	1298 MB/min.
59.94P 50.00P	[IPB]	8 min.	34 min.	138 min.	440 MB/min.
29.97P 25.00P 24.00P 23.98P	[ALL-I]	5 min.	23 min.	93 min.	654 MB/min.
29.97P 25.00P 24.00P 23.98P	[IPB]	16 min.	67 min.	270 min.	225 MB/min.

● In MP4 Format (Approx.)

Movie Recording Quality	Total Recording Time on Card			File Size	
	4 GB	16 GB	64 GB		
FHD : Full HD					
59.94P 50.00P	[IPB]	8 min.	35 min.	141 min.	431 MB/min.
29.97P 25.00P 24.00P 23.98P	[IPB]	17 min.	70 min.	281 min.	216 MB/min.
29.97P 25.00P	[IPB]	43 min.	173 min.	695 min.	87 MB/min.

 An increase of the camera's internal temperature may cause movie shooting to stop before the maximum recording time shown in the table (p.341).

● **Movie Files Exceeding 4 GB**

Even if you shoot a movie exceeding 4 GB, you can keep shooting without interruption.

● **Using CF cards up to 128 GB formatted with the camera**

If you use the camera to format a CF card with 128 GB or less in capacity, the camera will format it in FAT32.

With a FAT32-formatted CF card, if you shoot a movie and the file size exceeds 4 GB, a new movie file will be created automatically.

When you play back the movie, you will have to play each movie file individually. Movie files cannot be played back automatically in consecutive order. After the movie playback ends, select the next movie and play it back.

● **Using CF cards exceeding 128 GB and CFast cards formatted with the camera**

If you use the camera to format a CF card with more than 128 GB in capacity, the camera will format it in exFAT.

When using an exFAT-formatted card, even if the file size exceeds 4 GB during movie shooting, the movie will be saved as a single file (rather than being split into multiple files).

 Deleting any of the movie files created when a movie shot at one time exceeds 4GB will make it impossible for EOS MOVIE Utility (p.551) to play back the movie files consecutively or to merge and save them as a single movie file.

 Using EOS MOVIE Utility, you can automatically merge multiple MOV format movies files split when exceeding 4 GB and save them as a single movie file.

- **Movie Shooting Time Limit**

- **When shooting movies other than High Frame Rate movies**

The maximum recording time of one movie clip is 29 min. 59 sec. If the movie shooting time reaches 29 min. 59 sec., the movie shooting will stop automatically. You can start shooting a movie again by pressing the < $\frac{\text{START}}{\text{STOP}}$ > button. (The movie will be recorded as a new movie file.)

- **When shooting High Frame Rate movies**

The maximum recording time of one movie clip is 7 min. 29 sec. If the movie shooting time reaches 7 min. 29 sec., the movie shooting will stop automatically. You can start shooting a movie at a high frame rate again by pressing the < $\frac{\text{START}}{\text{STOP}}$ > button. (The movie will be recorded as a new movie file.)

MENU Setting the Sound Recording

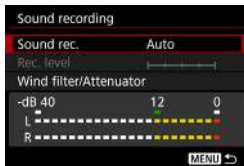

You can shoot movies while recording sound with the built-in monaural microphone or an external stereo microphone (commercially-available). You can also freely adjust the sound-recording level.

Set the sound recording with [CAMERA 4: Sound recording].

Sound Recording/Sound Recording Level

Auto : The sound-recording level is adjusted automatically. Auto level control will operate automatically in response to the sound level.

Manual : For advanced users. You can adjust the sound-recording level to one of 64 levels.

Select [Rec. level] and turn the <DIAL> dial while looking at the level meter to adjust the sound-recording level. Look at the peak hold indicator, and adjust so that the level meter sometimes lights up on the right of the “12” (-12 dB) mark for the loudest sounds. If it exceeds “0”, the sound will be distorted.

Line input : The audio can come through the Line input. The sound input will be recorded together with the image to the movie. You can adjust the sound-recording level to one of 64 levels. The adjustment method is the same as with [Manual].

Disable : Sound will not be recorded. Also, sound will not be output for the HDMI output (p.338).

 High Frame Rate movies do not record sound. Also, [CAMERA 4: Sound recording] cannot be set.

Wind Filter/Attenuator

- Wind filter** : When **[Enable]** is set, it reduces the wind noise when recording outdoors. This feature works only when you use the built-in microphone for movie shooting. Note that **[Enable]** reduces low bass sounds, so set it to **[Disable]** when there is no wind. It will record a more natural sound than with **[Enable]**.
- Attenuator** : Automatically suppresses sound distortion caused by loud noises. Even if **[Sound rec.]** is set to **[Auto]** or **[Manual]** before shooting, sound distortion may still result if there is a very loud sound. In such a case, setting it to **[Enable]** is recommended.
-



● Using the microphone

Normally, the built-in microphone for movie shooting records monaural sound. Stereo sound recording is possible by connecting an external stereo microphone (commercially-available) equipped with a miniature stereo plug (3.5 mm diameter) to the camera's external microphone IN terminal (p.28).

● Line input



Line out stereo sound from a mixer, etc., can be input directly to the camera. By connecting a miniature stereo plug (3.5 mm diameter) to the camera's Line IN terminal (p.28), stereo sound will be recorded with the movie. The standard IN level is -8 dBV. Adjust the sound recording level to suit the Line OUT level.

● Using headphones

By connecting headphones (commercially-available) equipped with a 3.5 mm diameter mini plug to the camera's headphone terminal (p.28), you can listen to the sound during movie shooting. If you are using an external stereo microphone (commercially-available), you can listen to the sound in stereo. To adjust the headphones' sound volume, press the  button and select . Then turn  to adjust (p.310).

You can also use headphones during movie playback.



- The camera's built-in microphone will also record the operation sound during shooting and mechanical sound of the camera. Use an external microphone (commercially-available) to reduce these sounds in the movie.
- Line IN can handle sound input of up to +6 dBV. However, if the sound input exceeds the standard input level of -8 dBV, the distortion may increase. Taking test shots beforehand is recommended.
- For Line input, be sure that [**Sound rec.**] is set to [**Line input**]. If [**Line input**] is not set and the sound is input, it may cause a malfunction.
- When [**Line input**] is set, the built-in microphone for movie shooting will not record the sound. Also, [**Wind filter**] and [**Attenuator**] cannot be set (do not work).
- When using headphones for audio, noise reduction will not be applied to the headphone output. Because of this, what you hear will differ from the actual audio recorded with the movie.
- When listening to the sound with headphones, do not change the [**Manual**] and [**Line input**] settings. Doing so may cause a sudden increase in the sound level and hurt your ears.



- When the camera is connected to a TV set with an HDMI cable, the sound will also be output (except when [**Sound rec.: Disable**] is set). If there is audio feedback when the sound is output from the TV set, place the camera farther away from the TV set or turn down the TV sound volume.
- The sound volume balance between L (left) and R (right) cannot be adjusted.
- Audio is recorded at a 48 kHz/16-bit sampling rate.
- If [**5: Silent Control**] is set to [**Enable** ] (p.325), you can adjust the sound-recording level with the  touch pad with less operation sound during movie shooting.

MENU Silent Control

You can change the settings of the ISO speed, sound-recording level, etc. while suppressing the operation sound during movie shooting.



When [**5: Silent Control**] is set to [**Enable** , you can use the touch pad < > on the inner ring of the Quick Control Dial.







You can just touch on the top, bottom, left, or right of < > for silent operation. During movie shooting, you can press the < > button to enable the Quick Control operation and change the functions below with < >.

Settable Functions	Shooting Mode			
	P/bulb	Tv	Av	M
Shutter speed	–	○	–	○
Aperture	–	–	○	○
Exposure	○	○	○	○*1
ISO speed	–	–	–	○
Recording level*2	○	○	○	○
 Volume	○	○	○	○

*1: With ISO Auto set.

*2: With [**Sound recording: Manual/Line input**] set.



- If [**5: Silent Control**] is set to [**Enable** , you cannot perform Quick Control setting with the < > Quick Control Dial or < > Main Dial during movie shooting.
- Even if you change the aperture silently with < >, the movie will still record the lens aperture-driving sound.
- If there is water or dirt on the < >, the touchscreen operation may not work. In such a case, use a clean cloth to clean the < >. If it still does not work, wait a while and operate it again.



Before shooting a movie, you can use < > with the [**Rec. level**] setting to adjust the sound-recording level.

MENU Setting the Time Code



The time code is a time reference recorded automatically to synchronize the movie during movie shooting. It is recorded at all times in the following units: hours, minutes, seconds, and frames. It is mainly used during movie editing.

Set the time code with [**5: Time code**].

Count Up

Rec run : The time code counts up only while you are shooting a movie. The time code will continue in the sequence of the movie files captured.

Free run : The time code counts up whether you are shooting a movie or not.

Start Time Setting

You can set the time code's start time.

Manual input setting: You can freely set the hour, minute, second, and frames.

Reset : The time set with [**Manual input setting**] and [**Set to camera time**] is reset to "00:00:00." or "00:00:00." (p.329).

Set to camera time : Sets hours, minutes, and seconds to match the camera's internal clock. "Frames" will be set to "00".

- If you shoot a High Frame Rate movie with [**Free run**] set, the time code will not be appended.
- If [**Free run**] is set and you change the time, zone, or daylight saving time (p.55), the time code will be affected.
- If you play back an MP4 movie with a device other than the camera, the time code may not be displayed properly.

Movie Recording Count

You can select what to display on the movie shooting screen.

Rec time : Displays the elapsed time from the start of the movie shooting.

Time code : Displays the time code during movie shooting.

Movie Playback Count

You can select what to display on the movie playback screen.

Rec time : Displays the recording time and playback time during movie playback.

Time code : Displays the time code during movie playback.

With [Time code] set:



During movie shooting



During movie playback



- Regardless of the [Movie rec count] setting, the time code will always be recorded to the movie file (except for High Frame Rate movies with [Free run] set).
- The [Movie play count] setting under [CAMERA 5: Time code] switches in tandem with the [CAMERA 3: Movie play count] setting. Changing either setting will automatically change the other.
- "Frames" are not displayed for movie shooting or during movie playback.

HDMI

- **Time code**

The time code can be appended to a movie that is output via HDMI.

Enable: Appends time code to HDMI video output. When **[Enable]** is set, **[Rec Command]** will be displayed.

Disable: Time code not appended to HDMI video output.

- **Record command**

When a video output via HDMI is recorded by an external recording device, the camera's movie shooting start/stop can sync with the recording by an external recording device.

Enable: The movie shooting start/stop syncs with the recording by an external recording device.

Disable: The recording start/stop is controlled by the external recording device.

- During High Frame Rate movie shooting, if **[Count up]** in **[Time code]** is set to **[Free run]**, the time code will not be appended to the HDMI video output.
- To check whether your external recording device is compatible with the **[Time code]** or **[Rec Command]**, consult the manufacturer.
- Even if you set **[Time code]** to **[Disable]**, time code may be appended to the movie depending on the specifications of the external recording device. For specifications of time code during HDMI input, consult the manufacturer of the external recording device.

Drop Frame

If the frame rate is set to **119.9P** (119.9 fps), **59.94P** (59.94 fps), or **29.97P** (29.97 fps), the time code's frame count causes a discrepancy between the actual time and time code. When **[Enable]** is set, this discrepancy is corrected automatically. This correction function is called "drop frame." This is for advanced users editing movies.

Enable : The discrepancy is corrected automatically by skipping time code numbers (DF: Drop frame).

Disable : The discrepancy is not corrected (NDF: Non-drop frame).

The time code will be displayed as follows:

Enable (DF) : 00:00:00. (Playback time: 00:00:00.00)

Disable (NDF) : 00:00:00. (Playback time: 00:00:00.00)

 If the frame rate is **100.0P** (100.0 fps), **50.00P** (50.00 fps), **25.00P** (25.00 fps), **24.00P** (24.00 fps), or **23.98P** (23.98 fps), the drop frame will not work. (If **100.0P / 50.00P / 25.00P / 24.00P / 23.98P** is set or if [**3: Video system**] is set to **[For PAL]**, **[Drop frame]** will not be displayed.)

MENU Menu Function Settings

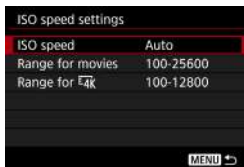

When the Live View shooting/Movie shooting switch is set to <[]>, the [2: ISO speed settings] options will change to [ISO speed], [Range for movies], and [Range for 4k].

● ISO Speed Setting

● ISO speed

In the <[**M**]> mode, you can set the ISO speed manually. You can also select ISO Auto. You can also use the <[ISO]> button for these settings.

● Range for movies

For Full HD movie shooting, you can set the ISO speed's automatic and manual setting ranges (minimum and maximum limits). The default setting is ISO 100 - ISO 25600. You can set the minimum limit within ISO 100 to H1 (equivalent to ISO 102400), and the maximum limit within ISO 200 to H2 (equivalent to ISO 204800).

● Range for 4k

For 4K movie shooting, you can set the ISO speed's automatic and manual setting ranges (minimum and maximum limits). The default setting is ISO 100 - ISO 12800. You can set the minimum limit within ISO 100 to H1 (equivalent to ISO 102400), and the maximum limit within ISO 200 to H2 (equivalent to ISO 204800).



- For Full HD shooting, ISO 32000/40000/51200 is the expanded ISO speed. For 4K movie shooting, it is ISO 16000/20000/25600/32000/40000/51200. When you set it, [H] will be displayed.
- For still photo shooting (viewfinder or Live View shooting), see page 166 for the [2: ISO speed settings].

📷4



When the Live View shooting/Movie shooting switch is set to <📷>, the [📷4] and [📷5] tabs dedicated to movie shooting will be displayed.

● Movie Servo AF

With this function enabled, the camera focuses on the subject continuously during movie shooting. The default setting is [Enable].

When [Enable] is set:

- The camera focuses the subject continuously even when you are not pressing the shutter button halfway.
- If you want to keep the focus at a specific point or if you do not want the lens mechanical sound to be recorded, you can temporarily stop Movie Servo AF as follows.
 - Tap on the [SERVO AF] icon on the lower left of the screen.
 - Under [📷6: Custom controls], if a button is assigned to [Pause Movie Servo AF] (p.452), you can pause Movie Servo AF while holding down that button. When you press the button again, Movie Servo AF will resume.
 - If a button is assigned to [AF stop] (p.449), Movie Servo AF will stop while holding down that button. When you let go of the button, Movie Servo AF will resume.
- While Movie Servo AF is paused, if you return to movie shooting after operations such as pressing the <MENU> or <▶> button, changing the AF method, etc., Movie Servo AF will resume.

When [Disable] is set:

- Press the shutter button halfway or press the <AF-ON> button to focus.



Cautions When [Movie Servo AF] is Set to [Enable]

- **Shooting Conditions that Make Focusing Difficult**
 - A fast-moving subject approaching or moving away from the camera.
 - A subject moving at a close distance in front of the camera.
 - With a higher f/number
 - Also see “Shooting Conditions that Make Focusing Difficult” on page 289.
- Since this drives the lens continuously, it will consume battery power and shorten the movie shooting time (p.307).
- With certain lenses, the mechanical sound of the lens for focusing may be recorded. If this happens, you can use an external microphone (commercially-available) to reduce the mechanical sound of the lens to be recorded.
- Movie Servo AF will pause during zooming or magnified view.
- During movie shooting, if a subject approaches or moves away or if the camera is moved vertically or horizontally (panning), the recorded movie image may momentarily expand or contract (change in image magnification).
- If you want to set the lens' focus mode switch to <MF> during Movie Servo AF, first set the Live View shooting/Movie shooting switch to < >.

- **AF method**

You can select [**L** +Tracking] or [FlexiZone - Single]. See page 284 for the AF method.

- **Grid display**

With [**3x3** 田] or [**6x4** 田田], you can display grid lines to help you level the camera vertically or horizontally. Also, with [**3x3+diag** 田田], the grid is displayed together with diagonal lines to help you compose with better balance by aligning the intersections over the subject.

Note that the grid is not displayed during movie shooting.

- **Movie recording quality**

You can set the movie-recording format (MOV or MP4), movie-recording size, 24.00p, and High Frame Rate. For details, see page 311.

- **Sound recording**

You can set sound-recording settings. For details, see page 322.

● Movie Servo AF Speed



You can set the Movie Servo AF's AF speed and its operation conditions.

This function is settable when **[Movie Servo AF]** is set to **[Enable]** and **[AF method]** is set to **[FlexiZone - Single]**. Additionally, the function is enabled when using a lens supporting slow focus transition during movie shooting*.

When active : **[Always on]** sets the AF adjustment speed to take effect at all times for movie shooting (before and during movie shooting). **[During shooting]** sets the AF adjustment speed to take effect only during movie shooting.

AF speed : You can adjust the AF speed (focus transition speed) from standard speed to slow (one of seven levels) or fast (one of two levels), to obtain the desired effect for movie creation.

*** Lenses supporting slow focus transition during movie shooting**
USM and STM lenses released in and after 2009 are compatible. For details, refer to Canon website.

 Setting **[AF method]** to **[L+Tracking]** gives the same effect as **[AF speed]** set to **[Standard (0)]**.

● Movie Servo AF tracking sensitivity



You can change the Movie Servo AF's tracking sensitivity to one of seven levels. This affects the responsiveness of AF tracking sensitivity when the AF points stray from the subject, such as during panning or when an obstacle cuts across the AF points.

This function is settable when **[Movie Servo AF]** is set to **[Enable]** and **[AF method]** is set to **[FlexiZone - Single]**.

Locked on: -3/-2/-1

This setting makes the camera less inclined to track a different subject if the AF point loses the original subject. The closer the setting is to the minus (-) symbol, the less the camera is inclined to track a different subject. It is effective when you want to prevent the AF points from rapidly tracking something that is not the intended subject during panning or when an obstacle cuts across the AF points.

Responsive: +1/+2/+3

This makes the camera more responsive when tracking a subject that covers the AF point. The higher the setting to the plus (+) symbol, the more responsive the camera is. It is effective when you want to keep tracking a moving subject as its distance from the camera changes, or to rapidly focus on another subject.

 Setting **[AF method]** to **[$\dot{\cup}$ +Tracking]** gives the same effect as setting **[0]**.

 5

- **Metering timer**

You can change how long the exposure setting is displayed (AE lock time).

- **LV touch control**

During Live View shooting or movie shooting, you can touch the LCD monitor (touch-sensitive panel) with your fingers to move the AF point or magnify the image.

[**Standard**] is the normal setting. [**Sensitive**] provides a better touchscreen response than [**Standard**]. Try using both settings and select the one you prefer. To disable touchscreen operations, select [**Disable**].

- **Time code**

You can set the time code. For details, see page 326.

 Regardless of the [**Beep**] setting, no beeper will sound for touchscreen operations. However, when focus is achieved with AF, the beeper (focus confirmation beep) will sound depending on the [**Beep**] setting.





● Silent control



When [Enable  > touch pad with the Quick Control to change settings while suppressing the operation sound during movie shooting. For details, see page 325.

● button function





You can set the functions performed by pressing the shutter button halfway or completely during movie shooting.

Setting	Pressing halfway	Pressing completely
	Metering and AF	No function
	Metering only	No function
	Metering and AF	Starts/stops movie shooting
	Metering only	Starts/stops movie shooting

If [] or [] is set, besides pressing the < > button, you can start/stop the movie shooting by pressing the shutter button completely or by using Remote Switch RS-80N3 or Timer Remote Controller TC-80N3 (both sold separately, p.258).



During movie shooting, the [ **btn function**] setting overrides any function assigned to the shutter button with [ **6: Custom Controls**].

● HDMI display



This function enables you to select the display option while recording HDMI video output with an external recording device. The movie will be output in Full HD quality (1920x1080). The default setting is [📺].

● When [📺] is set:

- When outputting a movie via HDMI, the camera's LCD monitor will be off.
- The shooting information, AF points, etc., will be displayed on the HDMI video output. However, if you press the <INFO.> button while watching the external monitor connected to an external recording device, you can see the output video without the information.
- Without having an HDMI connection, even if you press the <INFO.> button while watching the camera's LCD monitor, the output will still display the information.
- To record a video without an information overlay, check that no shooting information or AF point is being displayed on the external monitor, etc. Setting [📺**without info**] is recommended.

● When [📺**without info**] is set:



- When outputting a movie via HDMI, the camera's LCD monitor will be off.
- The HDMI output will include only the movie image (shooting information, AF points, etc., will not be displayed).

● When [📷+📺] is set:

- While displaying the movie on the LCD monitor, you can display the movie as an HDMI output.
- Even if you play back images or display a menu, the images or menu will not be displayed on the HDMI output device.

? How to prolong the HDMI output

To continue the HDMI output for longer than 30 min., select [] or [] **without info**, then set [**2: Auto Power Off**] to [**Disable**] (p.76).

- 
 - HDMI output in 4K quality is not possible. (Even if [**Movie rec. size**] is set to **4k**, the movie will be output in Full HD quality.)
 - HDMI output with no information will not display the card's remaining capacity, battery level, internal temperature warning (p.341), and other warnings on the HDMI output device's screen. Be particularly careful when setting [] **without info**. When []+ [] is set, you can see the warnings displayed on the camera's LCD monitor.
 - When there is no movie shooting, the power will turn off automatically after the set time for [**2: Auto power off**] elapses. If you select []+ [] and set [**2: Auto power off**] to [**Disable**], the HDMI output will stop if you do not operate the camera for 30 min. (movie shooting will stop).
 - With [] **without info** set and you press the <DRIVE•AF> or <WB> button, etc., the setting screen may be displayed in the HDMI video output. While recording a movie to an external recording device, operating the buttons is not recommended.
 - Depending on the viewing environment, the brightness and color of the movie shot with the camera may look different from that of the HDMI video output recorded by an external recording device.
- 
 - By pressing the <INFO.> button, you can change the information displayed on the screen.
 - A time code can be appended to the HDMI video output (p.328).
 - Sound will also be output for the HDMI output (except when [**Sound rec.: Disable**] is set).

3

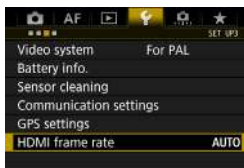

● HDMI frame rate

For HDMI output, you can set the frame rate to **[Auto]**, **[59.94i/50.00i]**, **[59.94p/50.00p]**, or **[23.98p]**. Set the frame rate that is compatible with the commercially-available, external recording device you will use to record the movie via HDMI output.

- When **[24.00p]** under **[4: Movie rec quality]** is set to **[Enable]**, you cannot set **[3: HDMI frame rate]**. The movie will be output at 1080/24.00p via HDMI.
- With HDMI output at **[4k 59.94p / 50.00p]**, the 29.97p/25.00p movie will be output via HDMI according to the **[HDMI frame rate]** setting.
- The HDMI output during High Frame Rate movie shooting will not output the movie at 119.9p/100.0p.

- The selectable frame rates will differ depending on the **[3: Video system]** setting.
- If the picture does not appear on the HDMI output device, set the **[3: Video system]** correctly to **[For NTSC]** or **[For PAL]** (depending on the video system of the output device).
- If the manually-set frame rate is not compatible with the external recording device, the frame rate will be set automatically.
- If **[3: HDMI frame rate]**'s **[59.94i]** or **[59.94p]** is used with the movie-recording size of **[23.98p]** (23.98 fps), "2-3 pulldown" processing will be done.



General Movie Shooting Cautions

Red <[Red Thermometer Icon]> Internal Temperature Warning Icon

- If the camera's internal temperature increases due to prolonged movie shooting or under a high ambient temperature, a red <[Red Thermometer Icon]> icon will appear.
- The red <[Red Thermometer Icon]> icon indicates that movie shooting will soon be terminated automatically. If this happens, you will not be able to shoot again until the camera's internal temperature decreases. Turn off the power and let the camera rest for a while.
- Shooting a movie at a high temperature for a prolonged period will cause the <[Red Thermometer Icon]> icon to appear earlier. When you are not shooting, always turn off the camera.

Recording and Image Quality

- If the attached lens has an Image Stabilizer and you set the Image Stabilizer (IS) switch to <ON>, the Image Stabilizer will operate at all times even if you do not press the shutter button halfway. The Image Stabilizer consumes battery power and may shorten the total movie shooting time depending on the shooting conditions. If you use a tripod or if the Image Stabilizer is not necessary, it is recommended that you set the IS switch to <OFF>.
- With autoexposure shooting or shutter-priority AE, if the brightness changes during movie shooting, the movie may freeze momentarily. In such a case, shoot movies with aperture-priority AE or manual exposure.
- If there is a very bright light source in the image, the bright area may appear black on the LCD monitor. The movie will be recorded almost exactly as it appears on the LCD monitor.
- In low light, noise or irregular colors may appear in the image. The movie will be recorded almost exactly as it appears on the LCD monitor.
- If you play back a movie with other devices, image or sound quality may deteriorate or playback may not be possible (even if the devices support MOV/MP4 format).

General Movie Shooting Cautions

Recording and Image Quality

- If you use a card with a slow writing speed, a five-level indicator may appear on the right of the screen during movie shooting. It indicates how much data has not yet been written to the card (remaining capacity of the internal buffer memory). The slower the card, the faster the indicator will climb upward. If the indicator becomes full, movie shooting will stop automatically. If the card has a fast writing speed, the indicator will either not appear or the level (if displayed) will hardly go upward. First, shoot a few test movies to see if the card can write fast enough.
- If the indicator indicates that the card is full and movie shooting stops automatically, the sound near the end of the movie may not be recorded properly.
- If the card's writing speed is slow (due to fragmentation) and the indicator appears, formatting the card may make the writing speed faster.



Indicator

Restrictions on MP4-format Movies

Note that generally the following restrictions apply to MP4-format movies.

- Sound will not be recorded for approx. the last two frames.
- When you play back movies on Windows, movie images and sound may become slightly out of synchronization.

9

Image Playback

This chapter explains how to play back and erase the images (still photos/movies), how to view them on a TV screen, and other playback-related functions.

Images shot and saved with another device

The camera may not be able to properly display images captured with a different camera, edited with a computer, or that have had their file names changed.

▶ Image Playback

Single-Image Display



1 Play back the image.

- Press the <▶> button.
- ▶ The last image captured or played back will appear.

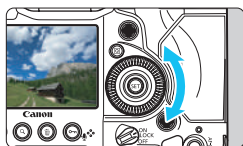

2 Select an image.

- To play back images starting with the last image captured, turn the <◀> dial counterclockwise. To play back images starting with the first captured image, turn the dial clockwise.
- Each time you press the <INFO.> button, the information display will change.



No information



Basic information display



Shooting information display

If [7: Add cropping information] is set to an option other than [Off (Aspect ratio 3:2)] (p.439), the captured photos will show the lines indicating the image area when played back.

3 Exit the image playback.

- Press the <▶> button to exit the image playback and return to shooting-ready state.

Shooting Information Display

With the shooting information screen displayed (p.344), you can tilt <⬅> up or down to switch the shooting information displayed at the screen bottom as follows. For details, see pages 347-349.

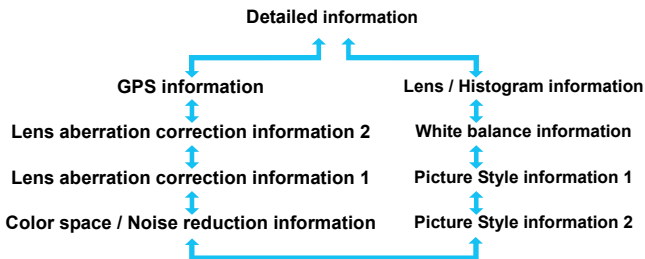

MENU Grid Display

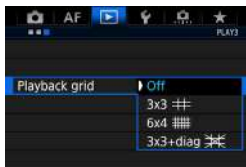

In the single-image display, you can overlay the grid on the playback image. With [▶3: Playback grid], you can select [3x3 3x3], [6x4 6x4], or [3x3+diag 3x3+diag].

This function is convenient for checking the image's vertical or horizontal tilt as well as composition.

The grid is not displayed during movie playback.

INFO.: Shooting Information Display

Sample Information for Still Photos

● Basic information display

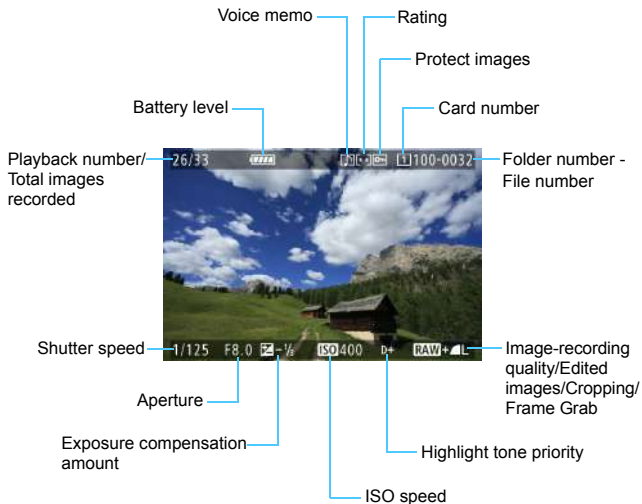

- If the image was taken by another camera, certain shooting information may not be displayed.
- It may not be possible to play back images taken with this camera on other cameras.

● Shooting information display

• Detailed information

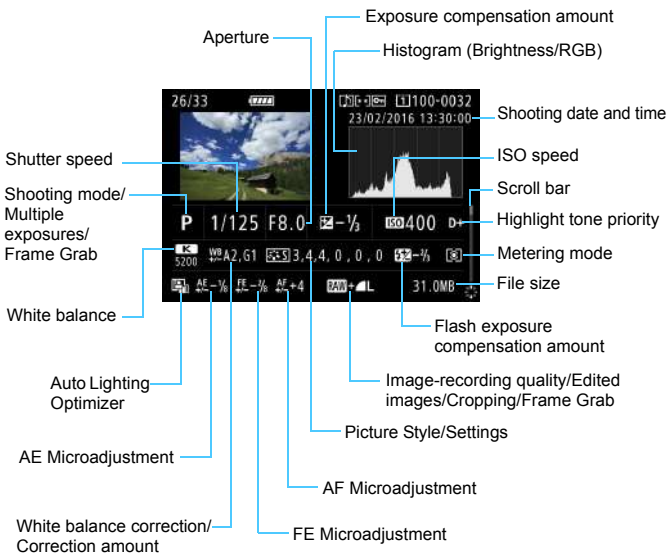

- * When you shoot in RAW+JPEG image quality, the RAW image file size will be displayed.
- * Images appended with cropping information (p.439) will have lines indicating the image area.
- * For images shot with flash not applying flash exposure compensation, <f> will be displayed.
- * Multiple-exposure photos are indicated with <M>.
- * RAW-processed images, resized images, cropped images, and frame-grab images are indicated with <R>.
- * For images cropped and then saved, <C> will be displayed.

• Lens/Histogram information

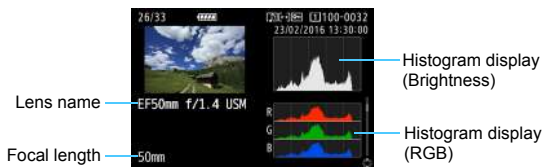

• White balance information



• Picture Style information 1



• Picture Style information 2



ⓘ Frame-grab images from 4K movies saved as still photos (p.374) will not display certain shooting information screens.

- Color space / Noise reduction information

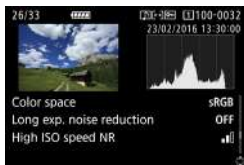

- Lens aberration correction information 1



- Lens aberration correction information 2



- GPS information

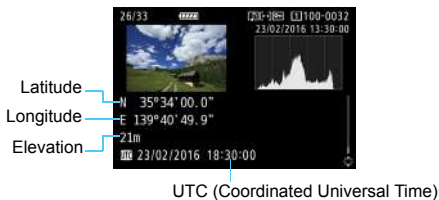

If the GPS information is not recorded to the image, GPS information screen will not be displayed.

Sample Movie Information Display

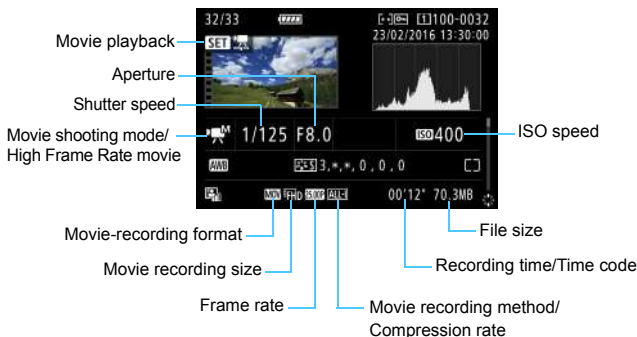

< / >: Shutter speed, aperture, and ISO speed are not displayed.

< / >: Aperture and ISO speed are not displayed.

< / >: Shutter speed and ISO speed are not displayed.

< / > + ISO Auto: ISO speed is not displayed.

During movie playback, “*,” “*” will be displayed for [Fineness] and [Threshold] of [Picture Style]’s [Sharpness].

● Highlight Alert

When [3: Highlight alert] is set to [Enable], overexposed, clipped highlights will blink. To obtain more detailed gradation in the overexposed, blinking areas, set the exposure compensation to a negative amount and shoot again.

- **AF Point Display**

When [**▶3: AF point disp.**] is set to [**Enable**], the AF point that achieved focus will be displayed in red. If automatic AF point selection is set, multiple AF points may be displayed.

- **Histogram**

The brightness histogram shows the exposure level distribution and overall brightness. The RGB histogram is for checking the color saturation and gradation. The display can be switched with [**▶3: Histogram disp.**].

- **[Brightness] Display**

This histogram is a graph showing the distribution of the image's brightness level. The horizontal axis indicates the brightness level (darker on the left and brighter on the right), while the vertical axis indicates how many pixels exist for each brightness level. The more pixels there are toward the left, the darker the image. The more pixels there are toward the right, the brighter the image. If there are too many pixels on the left, the shadow detail will be lost. If there are too many pixels on the right, the highlight detail will be lost. The gradation in-between will be reproduced. By checking the image and its brightness histogram, you can see the exposure level inclination and the overall gradation.

Sample Histograms



Dark image



Normal brightness



Bright image

- **[RGB] Display**

This histogram is a graph showing the distribution of each primary color's brightness level in the image (RGB or red, green, and blue). The horizontal axis indicates the color's brightness level (darker on the left and brighter on the right), while the vertical axis indicates how many pixels exist for each color brightness level. The more pixels there are toward the left, the darker and less prominent the color. The more pixels there are toward the right, the brighter and denser the color. If there are too many pixels on the left, the respective color information will be lacking. If there are too many pixels on the right, the color will be too saturated with no gradation. By checking the image's RGB histogram, you can see the color's saturation and gradation condition, as well as white balance inclination.

▶ Searching for Images Quickly

▣ Display Multiple Images on One Screen (Index Display)

Search for images quickly with the index display showing 4, 9, 36, or 100 images on one screen.

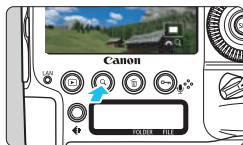

1 Press the <Q> button.

- During image playback or when the camera is ready to shoot, press the <Q> button.
- ▶ [🌀 Q] will be displayed on the lower right of the screen.



2 Switch to the index display.

- Turn the <🌀> dial counterclockwise.
- ▶ The 4-image index display will appear. The selected image is highlighted with an orange frame.
- Turning the <🌀> dial further counterclockwise will switch the display from 9 images, 36 images and to 100 images. If you turn the dial clockwise, it will rotate through 100, 36, 9, 4, and single-image display.



3 Select an image.

- Operate <🌀> or the <🕒> dial to move the orange frame and select the image.
- Press the <Q> button to turn off the [🌀 Q] icon, then turn the <🌀> dial will display the image(s) on the next or previous screen.



- Press <SET> in the index display to display the selected image in the single-image display.

Jumping through Images (Jump Display)

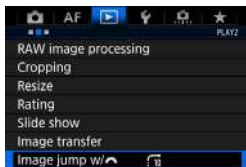
In the single-image display, you can turn the <  > dial to jump through the images forward or backward according to the jump method set.



1 Select [Image jump w/].

- Under the [ 2] tab, select [Image jump w/ ], then press <  >.



2 Select the jump method.

- Select the jump method, then press <  >.

 : Display images one by one

 : Jump 10 images

 : Jump 100 images

 : Display by date

 : Display by folder

 : Display movies only

 : Display stills only

 : Display protected images only

 : Display by image rating (p.361)

Turn the <  > dial to select.



Jump method

Playback position

3 Browse by jumping.

- Press the <▶> button to play back images.
- In the single-image display, turn the <⚙> dial.
- ▶ You can browse by the method that was set.



- To search images by shooting date, select **[Date]**.
- To search images by folder, select **[Folder]**.
- If the card contains both movies and still photos, select **[Movies]** or **[Stills]** to display one or the other.
- If the jump method is set to **[Protect]** or **[Image Rating]** but no images are protected or have ratings, you cannot use the <⚙> dial to browse through images.

Q Magnifying Images

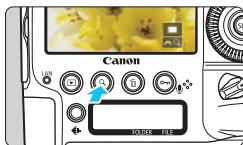
You can magnify a captured image by approx. 1.5x to 10x on the LCD monitor.



1 Magnify the image.



- The image can be magnified as follows: 1. During image playback (single-image display), 2. During the image review after image capture, and 3. From the shooting-ready state.
- Press the **<Q>** button.
- ▶ The magnified view will appear. The magnified area and [ **Q**] will be displayed on the lower right of the screen.
- The image magnification increases as you turn the **<>** dial clockwise. You can magnify the image up to approx. 10x.
- The image magnification decreases as you turn the **<>** dial counterclockwise. In the case of 1 and 3 only, turning the dial further will display the index display (p.352).

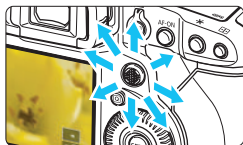

Magnified area position



2 Scroll around the image.

- Use **<>** to scroll around the magnified image.
- Press the **<Q>** button or **<>** button to exit the magnified view.



- In the case of 1 and 3 only, you can turn the **<>** dial to view another image while maintaining the magnified view.
- A movie cannot be magnified.

MENU Setting the Initial Magnification Ratio and Position

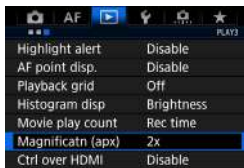

Under the [▶3] tab, when you select [Magnificatn (apx)], you can set the initial magnification ratio and position for the magnified view.

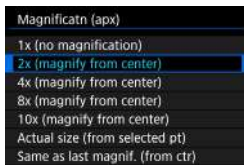

- **1x (no magnification)**
The image is not magnified. The magnified view will start with the single-image display.
- **2x, 4x, 8x, 10x (magnify from center)**
The magnified view starts at the image center at the selected magnification.
- **Actual size (from selected point)**
The recorded image's pixels will be displayed at approx. 110%. The magnified view starts at the AF point that achieved focus. If the photo is taken with manual focus, the magnified view starts at the image center.
- **Same as last magnification (from center)**
The magnification will be the same as the last time you exited the magnified view with the <▶> or <Q> button. The magnified view starts at the image center.



 For images taken with [L+Tracking] or [FlexiZone - Single] (p.284), or with [Distortion correction] set to [Enable] (p.195), the magnified view will start at the image center even if [Actual size (from selected pt)] is set.

Rotating the Image

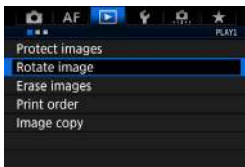
You can rotate the displayed image to the desired orientation.



1 Select [Rotate image].

- Under the [ 1] tab, select [Rotate image], then press < >.



2 Select the image to be rotated.







- Turn the < > dial to select the image to be rotated.
- You can also select an image in the index display (p.352).



3 Rotate the image.

- Each time you press < >, the image will rotate clockwise as follows: 90° → 270° → 0°.
- To rotate another image, repeat steps 2 and 3.



- If you set [ 1: Auto rotate] to [On  ] (p.390) before taking vertical shots, you need not rotate the image as described above.
- If the rotated image is not displayed in the rotated orientation during image playback, set [ 1: Auto rotate] to [On  ].
- A movie cannot be rotated.

☞ Protecting Images

By protecting the images, you can prevent the important images from being accidentally erased.

Protecting a Single Image with the <☞/📷> Button

1 Select the image to be protected.

- Press the <▶> button to play back images, then turn the <🕒> dial to select the image.

Image protection icon



2 Protect the image.

- When you press the <☞/📷> button, the image will be protected and the <🔒> icon will appear at the top of the screen.
- To cancel the image protection, press the <☞/📷> button again. The <🔒> icon will disappear.
- To protect another image, repeat steps 1 and 2.

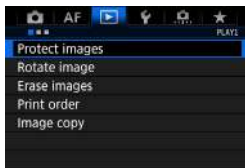
MENU Protecting a Single Image with the Menu**1** Select [**Protect images**].

- Under the [**1**] tab, select [**Protect images**], then press <SET>.

**2** Select [**Select images**].

- An image is displayed.

Image protection icon

**3** Select the image to be protected.

- Turn the <DIAL> to select the image to be protected.
- You can also select an image on the index display (p.352).

4 Protect the image.

- Press <SET> to protect the selected image. The <On> icon will appear at the top of the screen.
- To cancel the image protection, press <SET> again. The <On> icon will disappear.
- To protect another image, repeat steps 3 and 4.

MENU Protecting All Images in a Folder or on a Card

You can protect all the images in a folder or on a card at once.



When you select [**All images in folder**] or [**All images on card**] in [**▶ 1: Protect images**], all the images in the folder or on the card will be protected. To cancel the image protection, select [**Unprotect all images in folder**] or [**Unprotect all images on card**].

! If you format the card (p.74), the protected images will also be erased.

- Movies can also be protected.
- Once an image is protected, it cannot be erased by the camera's erase function. To erase a protected image, you must first cancel the protection.
- If you erase all the images (p.388), only the protected images will remain. This is convenient when you want to erase unnecessary images all at once.
- When [**All images on card**] or [**Unprotect all images on card**] is selected, the images will be protected or unprotected on the card selected for [**Record/play**] or [**Playback**] under [**▶ 1: Record func+card/folder sel.**].

Setting Ratings

You can rate images (still photos and movies) with one of the five rating marks: [★]/[☆]/[☆☆]/[☆☆☆]/[☆☆☆☆]. This function is called rating.

MENU Set Ratings with the Menu

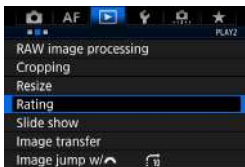

1 Select [Rating].

- Under the [▶] 2 tab, select [Rating], then press <SET>.



2 Select the image to be rated.

- Turn the <⦿> dial to select an image or movie to be rated.
- If you press the <Q> button and turn the <⦿> dial counterclockwise, you can select an image from a three-image display. To return to the single-image display, turn the dial clockwise.



3 Set the rating.

- Press <SET>, and a blue highlight frame will appear as shown in the screenshot.
- Turn the <⦿> dial to select a rating, then press <SET>.
- ▶ When you set a rating mark to the image, the total number of the images displayed beside the rating mark will be counted up.
- To rate another image, repeat steps 2 and 3.



A total of up to 999 images of a given rating can be displayed. If there are more than 999 images with a given rating, [###] will be displayed.

Rating with the <○-/🎧> Button

Under [..6: ○-/🎧 button function], if you set [Rating (○- and 🎧 disabled)] (p.438), you can press the <○-/🎧> button to rate images/movies during playback.

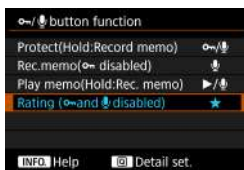

1 Set the <○-/🎧> button's function.

- Under the [..6] tab, set the [○-/🎧 button function] to [Rating (○- and 🎧 disabled)].

2 Select the image to be rated.

- Press the <▶> button to play back images, then turn the <🌀> dial to select the image to be rated.



3 Set the rating.

- Each time you press the <○-/🎧> button, the rating mark will change: [★]/[★]/[★]/[★]/[★]/None.
- To rate another image, repeat steps 2 and 3.



Taking Advantage of Ratings

- With [▶2: Image jump w/🌀], you can display only images with a specific rating.
- With [▶2: Slide show], you can play back only images with a specific rating.
- Depending on the computer's OS, you can see each file's rating as part of the file information display or in the provided image viewer (JPEG images only).

Recording and Playing back Voice Memos

You can append (record) a voice memo to a captured image. The voice memo will be saved as a WAV sound file having the same file number as the image. The voice memo can be played back by the camera or a computer.

Recording a Voice Memo

1 Select the image to which you want to append a voice memo.

- Press the <▶> button to play back images, then turn the <◉> dial to select the image to which you want to append a voice memo.

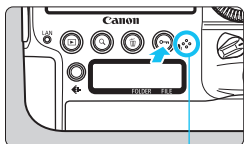

Voice memo microphone

2 Record a voice memo.

- Hold down the <⏻/🎤> button for approx. 2 sec.
- When [Recording memo...] appears, keep holding down the button and speak into the voice memo microphone. The maximum recording time for a voice memo is approx. 30 sec.
- To end the voice memo, let go of the button.
- ▶ The [🎤] icon will be displayed on the top of the screen.



- You cannot append a voice memo to a protected image.
- You cannot append a voice memo to a movie.
- A voice memo cannot be recorded with a commercially-available external microphone.



- With [..7: Memo audio quality], you can change the tone quality of the voice memo.
- To record a voice memo longer than 30 sec., repeat step 2.
- During image review immediately after shooting, you can also record a voice memo by following step 2. However, only one voice memo per image can be recorded in this way.

Playing a Voice Memo

When [**6:  button function**] is set to [**Play memo (Hold: Rec. memo)**] (p.438), the voice memo appended to the image can be played back.

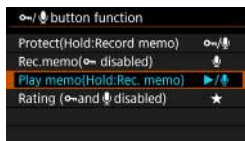



1 Set the < > button's function.

- Under the [**6**] tab, set [**voice memo icon** button function] to [**Play memo(Hold: Rec. memo)**].



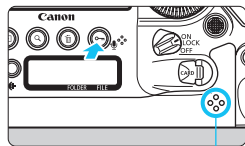

2 Select the image whose voice memo to play back.

- Press the < > button to play back images, then turn the < > dial to select an image with the [] icon displayed on the top of the screen.



Speaker

3 Play back a voice memo.

- Press the < > button to play back the voice memo.
- Turn the < > dial to adjust the sound volume.
- To stop playback, press the < > button.



- If the image is appended with multiple voice memos, they will be played back consecutively.
- You cannot erase only the voice memo appended to an image with the camera.
- If the image is erased (p.386), the voice memo(s) appended to the image will also be erased.

Q Quick Control for Playback

During playback, you can press the <Q> button to set the following: [**Protect images**], [**Rotate image**], [**★: Rating**], [**RAW image processing (RAW images only)**], [**Resize (JPEG image only)**], [**Highlight alert**], [**Cropping (JPEG images only)**], [**AF point display**], and [**Image jump w/** ].

For movies, **only the functions in bold above** can be set.





1 Press the <Q> button.

- During image playback, press the <Q> button.
- ▶ The Quick Control options will appear.











2 Select an item and set it.

- Tilt < > up or down to select a function.
- ▶ The setting of the selected function is displayed at the bottom.
- Turn the < > dial to set it.
- For RAW image processing, Resize, and Cropping, press <SET> and set the function. For details, see page 392 for RAW image processing, page 397 for Resize, and page 399 for Cropping.
- To cancel, press the <MENU> button.

3 Exit the setting.

- Press the <Q> button to exit the Quick Control.

 To rotate an image, set [**✓1: Auto rotate**] to [**On**  ]. If [**✓1: Auto rotate**] is set to [**On** ] or [**Off**], the [ **Rotate image**] setting will be recorded to the image, but the camera will not rotate the image for display.

- 
- Pressing the < > button during the index display will switch to the single-image display and the Quick Control screen will appear. Pressing the < > button again will return to the index display.
 - For images taken with another camera, the options you can select may be restricted.

Enjoying Movies

You can play back movies in the following three ways:

Playback on a TV Set

(p.379)



By connecting the camera to a TV set with HDMI Cable HTC-100 (sold separately), you can play back the camera's still photos and movies on the TV set.



- Even if the camera is connected to a TV set with an HDMI cable and a 4K movie is played back, it will be played back in Full HD quality. (Playback in 4K quality is not possible.)
- Since hard disk recorders do not have an HDMI IN port, the camera cannot be connected with an HDMI cable to a hard disk recorder.
- Even if the camera is connected with a USB cable to a hard disk recorder, movies and still photos cannot be played back or saved.

Playback on the Camera's LCD Monitor

(p.369)

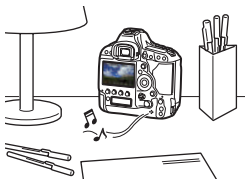

You can play back movies on the camera's LCD monitor.

You can also edit out the movie's first and last scenes, grab still photos from the 4K movie, and play back the still photos and movies on the card in an automatic slide show.



A movie edited with a computer cannot be rewritten to the card and played back with the camera.

Playback and Editing with a Computer



The movie files recorded on the card can be transferred to a computer and played back or edited with pre-installed or general-purpose software compatible with the movie's recording format.

- To play back or edit a movie with commercially-available software, use software compatible with MOV-format and MP4-format movies. For details on commercially-available software, contact the software manufacturer.
- MOV-format movies can also be played back with EOS MOVIE Utility (EOS software, p.551).

▶▶▶ Playing Back Movies

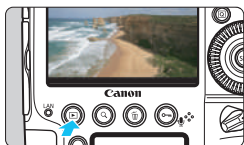

1 Play back the image.

- Press the <▶> button to play back images.



2 Select a movie.

- Turn the <◉> dial to select the movie to be played back.
- In the single-image display, the <SET ▶> icon displayed on the upper left indicates a movie.
- In the index display, perforations at the left edge of a thumbnail indicate a movie. **As movies cannot be played back from the index display, press <SET> to switch to the single-image display.**



3 In the single-image display, press <SET>.

- ▶ The movie playback panel will appear at the bottom of the screen.



4 Play back the movie.

- Turn the <◉> dial to select [▶] (Play), then press <SET>.
- ▶ The movie will start playing back.
- You can pause the movie playback by pressing <SET>. Press it again to resume the playback.
- You can adjust the sound volume during movie playback by turning the <◉> dial.

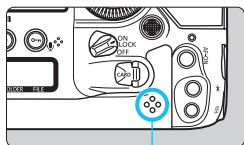

Speaker

- For more details on the playback procedure, see the next page.



- Before listening to a movie through headphones, turn down the volume to avoid hurting your ears.
- The camera may not be able to play back movies shot with another camera.

Movie Playback Panel

Operation	Playback Description
▶ Play	Pressing <Ⓢⓔᐓ> toggles between play and stop.
▶▶ Slow motion	Adjust the slow motion speed by turning the <Ⓢⓔᐓ> dial. The slow motion speed is indicated on the upper right of the screen.
◀◀ First frame	Displays the movie's first frame.
◀◀◀ Previous frame	Each time you press <Ⓢⓔᐓ>, the previous frame is displayed. If you hold down <Ⓢⓔᐓ>, it will rewind the movie.
▶▶▶ Next frame	Each time you press <Ⓢⓔᐓ>, the movie will play frame-by-frame. If you hold down <Ⓢⓔᐓ>, it will fast forward the movie.
▶▶▶▶ Last frame	Displays the movie's last frame.
✂ Edit	Displays the editing screen (p.372).
📷 Frame Grab	Selectable when a 4K movie is played. You can grab the frame displayed on the screen and save it as a JPEG still photo (p.374).
	Playback position
mm' ss"	Playback time (minutes:seconds with [Movie play count: Rec time] set)
hh:mm:ss.ff (DF) hh:mm:ss:ff (NDF)	Time code (hours:minutes:seconds:frames with [Movie play count: Time code] set)
🔊 Volume	Turn the <Ⓢⓔᐓ> dial to adjust the volume of the built-in speaker (p.369) or headphones.
MENU ↩	Press the <MENU> button to return to the single-image display.

Playing High Frame Rate Movies

Full HD movies shot at a high frame rate (119.9 fps or 100.0 fps) will be played back at 1/4-speed slow motion (29.97 fps or 25.00 fps). No sound will be played because no sound is recorded when shooting High Frame Rate movies. Note that each second of playback time and the time code count up equals to 1/4 sec. in real time.

- If you connect the camera to a TV set to play back a movie (p.379), adjust the sound volume with the TV set. (Turning the <☀> dial will not change the sound volume.) If there is audio feedback, place the camera farther away from the TV set or turn down the TV sound volume.
- If you detach or attach the lens, the card's writing speed is slow, or the movie file contains corrupted frames during movie playback, the movie playback will stop.

- With a fully-charged Battery Pack LP-E19, the continuous playback time at room temperature (23°C/73°F) will be approx. 4 hr. 30 min. (with **FHD** **29.97P** / **25.00P** / **24.00P** / **23.98P** **[IPB]** set).
- By connecting commercially-available headphones equipped with a 3.5 mm diameter stereo mini plug to the camera's headphone terminal (p.28), you can listen to the movie sound (p.324).

✂ Editing a Movie's First and Last Scenes

You can edit out the first and last scenes of a movie in approx. 1-sec. increments.



1 On the movie playback screen, select [✂].

- ▶ The movie editing panel will be displayed at the bottom of the screen.



2 Specify the part to be edited out.

- Select either [✂] (Cut beginning) or [✂] (Cut end), then press <SET>.
- Tilt <◂> to the left or right to see the previous or next frames. Holding down the key will fast forward or fast rewind the frames. Turn the <◂> dial for frame-by-frame playback.
- After deciding which part to edit out, press <SET>. The portion highlighted in white on the top of the screen is what will remain.



3 Check the edited movie.

- Select [▶] and press <SET> to play back the edited movie.
- To change the editing part, go back to step 2.
- To cancel the editing, press the <MENU> button, then select [OK] on the confirmation dialog.



4 Save the edited movie.

- Select [, then press < (SET) >.
- ▶ The save screen will appear.
- To save it as a new movie, select [**New file**]. To save it and overwrite the original movie file, select [**Overwrite**], then press < (SET) >.
- On the confirmation dialog, select [**OK**] to save the edited movie and return to the movie playback screen.



- Since the editing is performed in approx. 1-sec. increments (position indicated by [] on the top of the screen), the actual position where the movie is edited may differ from the position you specified.
- If the card does not have enough free space, [**New file**] will not be available.
- When the battery level is low, movie editing is not possible. Use a fully-charged battery.
- Movies shot with another camera cannot be edited with this camera.
- You cannot edit a movie when the camera is connected to a computer.



Grabbing a Frame from 4K Movies

From a 4K movie, you can select any desired frame to save it as an approx. 8.8 megapixel (4096x2160) still photo (JPEG image). This function is called “Frame Grab (4K frame capture)”.

1 Play back the image.

- Press the <▶> button to play back images.



2 Select a 4K movie.

- Turn the <◉> dial and select a 4K quality movie.
- On the shooting information screen (p.350), the 4K movie is indicated with the [4K] icon.
- With the index display, press <SET> to switch to the single-image display.

3 In the single-image display, press <SET>.

- ▶ The movie playback panel will appear at the bottom of the screen.



4 Select a frame to grab.

- Use the movie playback panel to select the frame to grab as a still photo.
- For details on using the movie playback panel, see page 370.



5 Select [Frame Grab].

- Turn the <◉> dial to select [Frame Grab], then press <SET>.



6 Save the frame.

- Select **[OK]** to save the frame displayed on the screen as a still photo (JPEG image).
- Check the destination folder and image file number.

7 Select the image to be displayed.

- Select **[View original movie]** or **[View extracted still image]**.
- ▶ The selected image will be displayed.



- Frame grabbing is not possible with Full HD movies or 4K movies shot with a different camera.
- Frame grabbing is not possible if the camera is connected to a computer.

MENU Slide Show (Auto Playback)

You can play back the images on the card as an automatic slide show.

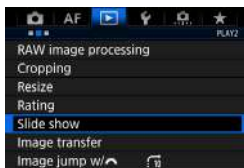

Number of images to be played back

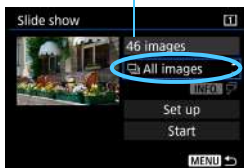

1 Select [Slide show].

- Under the [▶] 2 tab, select [Slide show], then press <SET>.

2 Select the images to be played back.

- Select the desired option on the screen, then press <SET>.

All images/Movies/Stills/Protect

- Turn the <◉> dial to select one of the following: [📁 All images] [🎞 Movies] [📷 Stills] [🔒 Protect]. Then press <SET>.

Date/Folder/Rating

- Turn the <◉> dial to select one of the following: [📅 Date] [📁 Folder] [★ Rating].
- When <INFO> [i] is highlighted, press the <INFO> button.
- Select the desired setting, then press <SET>.

Date



Folder



Rating



Item	Playback Description
All images	All the still photos and movies on the card will be played back.
Date	Still photos and movies taken on the selected shooting date will be played back.
Folder	Still photos and movies in the selected folder will be played back.
Movies	Only the movies on the card will be played back.
Stills	Only the still photos on the card will be played back.
Protect	Only the protected still photos and movies on the card will be played back.
Rating	Only the still photos and movies with the selected rating will be played back.

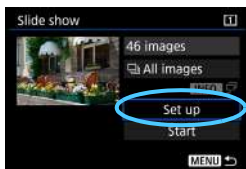

3 Set the playback as desired.

- Select [**Set up**], then press <SET>.
- Set the [**Display time**] and [**Repeat**] settings for still photos.
- After completing the settings, press the <MENU> button.

Display time

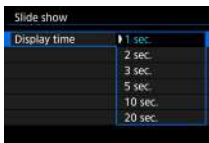

Repeat

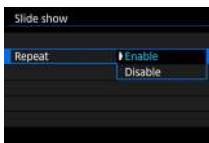

The images on the card selected for [**Record/play**] or [**Playback**] under [**1: Record func+card/folder sel.**] will be played back.



4 Start the slide show.

- Select [**Start**], then press <SET>.
- ▶ After [**Loading image...**] is displayed, the slide show will start.

5 Exit the slide show.

- To exit the slide show and return to the setting screen, press the <MENU> button.



- To pause the slide show, press <SET>. During pause, [||] will be displayed on the upper left of the image. Press <SET> again to resume the slide show.
- During the automatic playback of still images, you can press the <INFO.> button to switch the display format (p.344).
- During movie playback, you can adjust the sound volume by turning the <VOLUME> dial.
- During auto playback or pause, you can turn the <DIAL> dial to view another image.
- During auto playback, auto power off will not take effect.
- The display time may vary depending on the image.
- To view the slide show on a TV set, see page 379.

Viewing Images on a TV Set

By connecting the camera to a TV set with an HDMI cable (sold separately), you can play back the camera's still photos and movies on the TV set. For the HDMI cable, HDMI Cable HTC-100 (sold separately) is recommended.

If the picture does not appear on the TV screen, make sure to check if the **[F3: Video system]** is correctly set to **[For NTSC]** or **[For PAL]** (depending on the video system of your TV set).

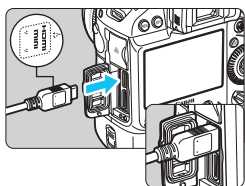

1 Connect the HDMI cable to the camera.

- With the plug's <▲HDMI MINI> logo facing the front of the camera, insert it into the <HDMI OUT> terminal.

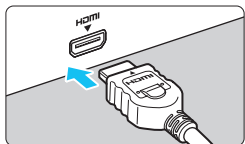

2 Connect the HDMI cable to the TV set.

- Connect the HDMI cable to the TV set's HDMI IN port.

3 Turn on the TV set and switch the TV set's video input to select the connected port.

4 Set the camera's power switch to <ON>.

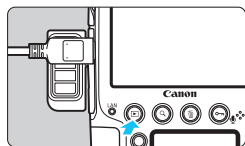

5 Press the <▶> button.

- ▶ The image will appear on the TV screen. (Nothing will be displayed on the camera's LCD monitor.)
- The images will automatically be displayed at the optimum resolution matching the connected TV set.
- By pressing the <INFO.> button, you can change the display format.
- To play back movies, see page 369.

- When the camera is connected to a TV set with an HDMI cable, even 4K movies will be played back in Full HD quality (they cannot be played back in 4K quality).
- Adjust movie sound volume with the TV set. The sound volume cannot be adjusted with the camera.
- Before connecting or disconnecting the cable between the camera and TV set, turn off the camera and TV set.
- Depending on the TV set, part of the image displayed may be cut off.
- Do not connect any other device's output to the camera's <HDMI OUT> terminal. Doing so may cause a malfunction.
- Certain TV sets may not be able to display the captured movies.

Using HDMI CEC TV Sets

If the TV set connected to the camera with an HDMI cable is compatible with HDMI CEC*, you can use the TV set's remote control for playback operations.

* An HDMI-standard function enabling HDMI devices to control each other so that you can control them with one remote control unit.

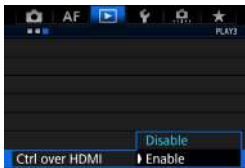

- 1 Select [Ctrl over HDMI].**
 - Under the [▶] 3 tab, select [Ctrl over HDMI], then press <SET>.
- 2 Select [Enable].**
- 3 Connect the camera to a TV set.**
 - Use an HDMI cable to connect the camera to the TV set.
 - ▶ The TV set's input will switch automatically to the HDMI port connected to the camera. If it does not switch automatically, use the TV set's remote control to select the HDMI IN port the cable is connected to.

4 Press the camera's <▶> button.

- ▶ An image will appear on the TV screen and you can use the TV set's remote control for playback.

5 Select an image.

- Point the remote control toward the TV set and press the ←/→ button to select an image.

Still photo playback menu



Movie playback menu



- : Return
- : 9-image index
- : Play movie
- : Slide show
- INFO.** : Display shooting info
- : Rotate

6 Press the remote control's Enter button.

- ▶ The menu appears and you can perform the playback operations shown on the left.
- Press the remote control's ←/→ button to select the desired option, then press the Enter button. For a slide show, press the ↑/↓ button to select an option, then press the Enter button.
- If you select [**Return**] and press the Enter button, the menu will disappear and you can use the ←/→ button to select an image.







- Some TV sets require you to first enable the HDMI CEC connection. For details, refer to the TV set's Instruction Manual.
- Certain TV sets, even those compatible with HDMI CEC, may not operate properly. In such a case, set [**▶3: Ctrl over HDMI**] to [**Disable**], and use the camera to control the playback operation.

Copying Images

You can copy the images recorded on one card (save duplicates) to the other card.



Movie Files Exceeding 4 GB

- If you are copying images from a CFast card () to a 128 GB or smaller CF card () formatted in FAT32, movie files exceeding 4 GB cannot be copied.
- Movie files exceeding 4 GB can be copied between a CFast card () and CF card () as long as the latter has a total capacity of 128 GB or greater and is formatted in exFAT.

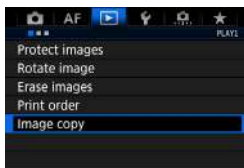
MENU Copying a Single Image



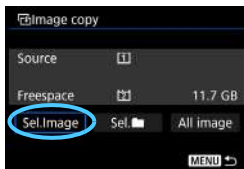

1 Select [Image copy].

- Under the [ 1] tab, select [Image copy], then press < >.



2 Select [Sel. Image].

- Check the copy source card's number and the target card's number and its remaining capacity.
- Select [Sel. Image], then press < >.

 The copy source is the card selected for [Record/play] or [Playback] under [ 1: Record func+card/folder sel.].



3 Select the folder.

- Select the folder containing the image you want to copy, then press $\langle \text{SET} \rangle$.
- Check the images displayed on the right to select the desired folder.
- ▶ The images in the selected folder will be displayed.



4 Select the images to be copied.

- Turn the $\langle \odot \rangle$ dial to select an image to be copied, then press $\langle \text{SET} \rangle$.
- ▶ The $[\checkmark]$ icon will appear on the upper left of the screen.
- If you press the $\langle Q \rangle$ button and turn the $\langle \odot \rangle$ dial counterclockwise, you can select an image from a three-image display. To return to the single-image display, turn the dial clockwise.
- To select another image to be copied, repeat step 4.

5 Press the $\langle \text{ON} / \text{OFF} \rangle$ button.

- After selecting all the images to be copied, press the $\langle \text{ON} / \text{OFF} \rangle$ button.

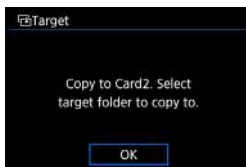

6 Select [OK].

- Check the card where the images will be copied to, then select [OK].

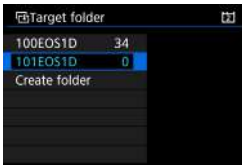

7 Select the target folder.

- Select the target folder to which you want to copy the images, then press <SET>.
- To create a new folder, select [**Create folder**].

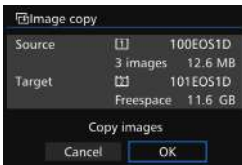

8 Select [OK].

- Check the information of the source card and target card, then select [**OK**].

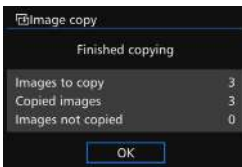

- ▶ The copying will start and the progress will be displayed.
- When the copying is completed, the result will be displayed. Select [**OK**] to return to the screen in step 2.

MENU Copying All Images in a Folder or on a Card

You can copy all the images in a folder or on a card at once.

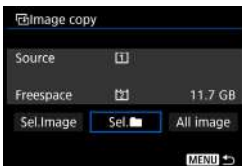

Under [**▶ 1: Image copy**], when you select [**Sel. [Folder Icon]**] or [**All image**], you can copy all the images in the folder or on a card.



- If an image is being copied to a target folder/card which has an image with the same file number, the following will be displayed: [**Skip image and continue**] [**Replace existing image**] [**Cancel copy**]. Select the copying method, then press <SET>>.
 - [**Skip image and continue**]: Any images having the same file number will be skipped and not copied.
 - [**Replace existing image**]: Any images having the same file number (including protected images) will be overwritten. If an image with a print order (p.413) is overwritten, you will have to set the print order again.
- If [**Sel. []**] or [**All image**] is selected and the folder or card has a movie file exceeding 4 GB that cannot be copied to the target, a message will appear. Only the still photos and the movie files not exceeding 4 GB will be copied.
- The image's print order information or image transfer information will not be retained when the image is copied.
- Shooting is not possible during the copying process. Select [**Cancel**] before shooting.



- The file name of the copied image will be the same as the source image's file name.
- If [**Sel. Image**] is set, you cannot copy images in multiple folders at once. Select images in each folder to copy them folder by folder.
- Any voice memos appended to the image will also be copied over.



Erasing Images

You can either select and erase unnecessary images one by one or erase them in one batch. Protected images (p.358) will not be erased.

! Once an image is erased, it cannot be recovered. Make sure you no longer need the image before erasing it. To prevent important images from being erased accidentally, protect them. Erasing a RAW+JPEG image will erase both the RAW and JPEG images.

Erasing a Single Image

1 Select the image to be erased.

- Press the < > button to play back images.
- Turn the < > dial to select the image to be erased.

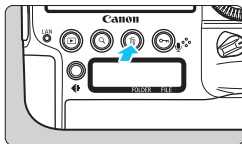

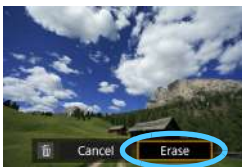

2 Press the < > button.

- ▶ The Erase menu will appear.



3 Erase the image.

- Select [Erase], then press < >. The image displayed will be erased.

 Setting [ 7: Default Erase option] to [[Erase] selected] makes it faster to erase images (p.441).

MENU Checkmarking [✓] Images to Be Erased in a Batch

By adding checkmarks <✓> to the images to be erased, you can erase multiple images at once.

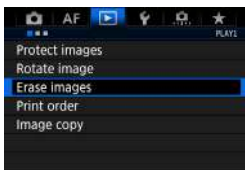

1 Select [Erase images].

- Under the [▶ 1] tab, select [Erase images], then press <SET>.

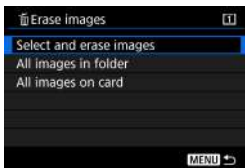

2 Select [Select and erase images].

- An image will be displayed.

3 Select the images to be erased.

- Turn the <DISP> dial to select the image to be erased, then press <SET>.
- A checkmark [✓] will be displayed on the upper left of the screen.
- If you press the <Q> button and turn the <DISP> dial counterclockwise, you can select an image from a three-image display. To return to the single-image display, turn the <DISP> dial clockwise.
- To select another image to be erased, repeat step 3.



4 Erase the image.

- Press the <TRASH> button, then press [OK].
- The selected images will be erased at once.

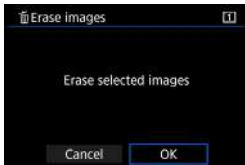

MENU Erasing All Images in a Folder or on a Card

You can erase all the images in a folder or on a card at once.

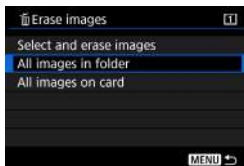

When [**▶ 1: Erase images**] is set to [**All images in folder**] or [**All images on card**], all the images in the folder or on the card will be erased.

- To erase all images including protected images, format the card (p.74).
- When [**All images on card**] is selected, the images in the card selected under [**▶ 1: Record func+card/folder sel.**] with [**Record/play**] or [**Playback**] will be erased.

Changing Image Playback Settings

MENU Adjusting the LCD Monitor Brightness

You can adjust the brightness of the LCD monitor to make it easier to view.



1 Select [LCD brightness].

- Under the [**F2**] tab, select [**LCD brightness**], then press <SET>.



2 Adjust the brightness.

- While referring to the gray chart, turn the <DIAL> dial, then press <SET>.



- To check the image's exposure, referring to the histogram is recommended (p.351).
- During playback, pressing the <INFO> button will display the screen in step 2.

MENU Auto Rotation of Vertical Images



Images shot in vertical orientation are rotated automatically to the proper orientation for viewing, so they will not be displayed in horizontal orientation when played back on the camera's LCD monitor or viewed on a computer screen. You can change the setting of this feature.

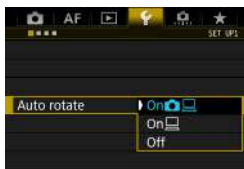

1 Select [Auto rotate].

- Under the [**1**] tab, select [**Auto rotate**], then press <SET>.

2 Set the display orientation.

- Select the desired setting, then press <SET>.

- On**  

The vertical image is automatically rotated during playback on both the camera's LCD monitor and on the computer.

- On** 

The vertical image is automatically rotated only on the computer.

- Off**

The vertical image is not automatically rotated.

 Auto rotation will not work with vertical images captured while auto rotation was [**Off**]. They will not rotate even if you later switch it to [**On**] for playback.

-  The image displayed immediately after shooting will not be automatically rotated.
- If a picture is taken while the camera is pointing up or down, automatic rotation to the proper orientation for viewing may not be performed correctly.
- If the vertical image is not automatically rotated on the computer screen, it means the software you are using does not support image rotation for display. Using the EOS software is recommended.

10

Post-Processing Images

This chapter explains RAW image processing, JPEG image resizing, and JPEG image cropping.



- The camera may not be able to process images taken with another camera.
- Post-processing images as described in this chapter cannot be performed when the camera is connected to a computer via an interface cable.

RAW/JPEG ↓ Processing RAW Images with the Camera

You can process **RAW** images with the camera and save them as JPEG images. As the RAW image itself does not change, you can apply different processing conditions to create any number of JPEG images from it.

Note that M RAW and S RAW images cannot be processed with the camera. Use Digital Photo Professional (EOS software, p.550) to process those images.

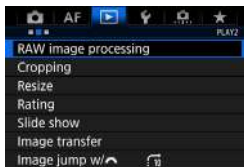

1 Select [RAW image processing].

- Under the [▶2] tab, select [**RAW image processing**], then press <SET>.
- RAW** images will be displayed.



2 Select the image to be processed.

- Turn the <◉> dial to select the image you want to process.
- If you press the <Q> button and turn the <☀> dial counterclockwise, you can select an image from the index display.



3 Set the desired processing conditions.

- Press <SET> to make the RAW-processing options appear in a while (p.394).
- Use <☀> to select an option, then turn the <◉> or <☀> dial to switch the setting.
- The displayed image will reflect such settings as “Brightness adjustment”, “White balance”, etc.
- To return to the image settings at the time of shooting, press the <INFO.> button.



Displaying the setting screen

- Press <[SET]> to display the selected function's setting screen. Turn the <[DISP]> or <[MODE]> dial to change the setting. Press <[SET]> to finalize the setting and return to the previous screen.



4 Save the image.

- Select [<Q>] (Save), then press <[SET]>.
- When you select [OK], the JPEG image created by processing will be saved to the card.
- Check the destination folder and image file number, then select [OK].
- To process another image, repeat steps 2 to 4.

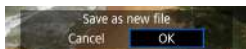







Magnified View

You can magnify the image by pressing the <[Q]> button in step 3. The magnification will differ depending on the [RAW image processing] screen's [Image quality] setting. With <[DISP]>, you can scroll around the magnified image.

To cancel magnified view, press the <[Q]> button again.

RAW Image Processing Options

-  **Brightness adjustment**
You can adjust the image brightness up to ± 1 stop in 1/3-stop increments. The displayed image will reflect the setting's effect.
-  **White balance** (p.177)
You can select the white balance. If you select [**AWB**] and press the <INFO.> button, you can select [**Auto: Ambience priority**] or [**Auto: White priority**]. If you select [**K**] and press the <INFO.> button, you can set the color temperature. The displayed image will reflect the setting's effect.
-  **Picture Style** (p.169)
You can select the Picture Style. By pressing the <INFO.> button, you can adjust the sharpness, contrast, and other parameters. The displayed image will reflect the setting's effect.
-  **Auto Lighting Optimizer** (p.189)
You can set the Auto Lighting Optimizer. The displayed image will reflect the setting's effect.
-  **High ISO speed noise reduction** (p.190)
You can set the noise reduction processing for high ISO speeds. The displayed image will reflect the setting's effect. If the effect is difficult to discern, magnify the image (p.393).
- **L Image quality** (p.155)
You can set the image-recording quality (image size and JPEG quality) of the JPEG image to be created. Tilt < > up or down to select the image size and JPEG quality.

- sRGB **Color space** (p.200)

You can select either sRGB or Adobe RGB. Since the camera's LCD monitor is not compatible with Adobe RGB, the difference in the image will hardly be perceptible when either color space is set.

-  **Lens aberration correction**

- OFF **Peripheral illumination correction** (p.194)



A phenomenon that makes the image corners look darker due to the lens characteristics can be corrected. If [**Enable**] is set, the corrected image will be displayed. If the effect is difficult to discern, magnify the image (p.393) and check the four corners. The peripheral illumination correction applied with the camera will be less pronounced than that applied with the Digital Photo Professional (p.550) at maximum correction amount. If the effects of correction are not apparent, use Digital Photo Professional to apply the peripheral illumination correction.

- OFF **Distortion correction**

Image distortion due to lens characteristics can be corrected. If [**Enable**] is set, the corrected image will be displayed. The image periphery will be trimmed in the corrected image. Since the image resolution may look slightly lower, adjust the sharpness with the Picture Style's [**Sharpness**] parameter setting as necessary.

- OFF **Digital Lens Optimizer**

By using optical design values, the lens aberrations, diffraction, and degraded resolution due to the low-pass filter can be corrected. Check the effects of the [**Enable**] setting with the magnified view (p.393). The unmagnified view (normal view) will not show the effects of the Digital Lens Optimizer. When [**Enable**] is selected, although the chromatic aberration correction and diffraction correction options will not be displayed, both will be applied to the processed image.

-  **Chromatic aberration correction** (p.195)
Chromatic aberrations (color fringing along the subject's outline) due to the lens characteristics can be corrected. If **[Enable]** is set, the corrected image will be displayed. If the effect is difficult to discern, magnify the image (p.393).
-  **Diffraction correction**
The diffraction by the lens aperture degrading the image sharpness can be corrected. If **[Enable]** is set, the corrected image will be displayed. If the effect is difficult to discern, magnify the image (p.393).

-  Processing RAW images in the camera will not produce exactly the same results as processing RAW images with Digital Photo Professional (EOS software).
- When **[Digital Lens Optimizer]** is set, noise may be intensified with the effects of correction.
- When **[Digital Lens Optimizer]** is set, certain shooting conditions may cause strong outlines to appear in the image. If necessary, adjust the Picture Style's Sharpness.
- When processing images with **[Distortion correction]** set to **[Enable]**, AF point display information (p.351) or Dust Delete Data (p.403) will not be appended to the image.

-  The lens correction data for lens aberration corrections is registered (stored) in the camera.
- The effect of the lens aberration correction will vary depending on the lens used and shooting conditions. Also, the effect may be difficult to discern depending on the lens used, shooting conditions, etc.
- The Digital Lens Optimizer's correction data for lenses newly released can be added with EOS Utility (EOS software, p.550).
- If **[Invalid correction data for Digital Lens Optimizer.]** is displayed, use EOS Utility (EOS software) to add the correction data for the Digital Lens Optimizer to the camera.

Resizing JPEG Images

You can resize a JPEG image to make the pixel count lower and save it as a new image. Resizing an image is possible with JPEG **L/M1/M2** images. **JPEG S** images, **RAW images**, and **frame-grab images from 4K movies saved as still photos** cannot be resized.

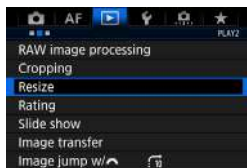

1 Select [Resize].

- Under the [**▶2**] tab, select [**Resize**], then press <ⓈET>.
- ▶ An image will be displayed.



2 Select the images to be resized.

- Turn the <☉> dial to select the image you want to resize.
- If you press the <Q> button and turn the <☉> dial counterclockwise, you can select an image from the index display.



Target sizes

3 Select the desired image size.

- Press <ⓈET> to display the image sizes.
- Select the desired image size, then press <ⓈET>.



4 Save the image.

- Select **[OK]** to save the resized image.
- Check the destination folder and image file number, then select **[OK]**.
- To resize another image, repeat steps 2 to 4.

Resize Options by Original Image Size

Original Image Size	Available Resize Settings		
	M1	M2	S
L	<input type="radio"/> *	<input type="radio"/>	<input type="radio"/>
M1		<input type="radio"/>	<input type="radio"/>
M2			<input type="radio"/>

 The item marked with an asterisk will be cropped slightly when resized.

✂ Cropping JPEG Images

You can crop a captured JPEG image and save it as another image. You can crop the JPEG images captured in **L**, **M1**, **M2**, and **S**. **RAW images and frame-grab images from 4K movies saved as still photos cannot be cropped.**

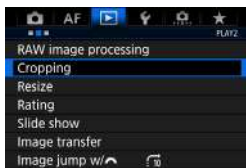

1 Select [Cropping].

- Under the [▶2] tab, select [Cropping], then press <SET>.
- ▶ An image is displayed.



2 Select an image.

- Turn the <◉> dial to select the image you want to crop.
- If you press the <Q> button and turn the <☀> dial counterclockwise, you can select an image from the index display.



3 Set the cropping frame size, position, and orientation.

- Press <SET> to display the cropping frame.
- The image area within the cropping frame will be cropped.

• Changing the Cropping Frame Size

Turn the <☀> dial to change the cropping frame size. The smaller the cropping frame, the more magnified the cropped image will look.

• Moving the Cropping Frame

Use <⦿> to move the frame over the image vertically or horizontally. Move the cropping frame until it covers the desired image area.

● Switching the Cropping Frame Orientation

Pressing the <INFO.> button will toggle the cropping frame between the vertical and horizontal orientations. This enables you to crop the image shot in horizontal orientation to look as if it was shot in vertical orientation.



4 Check the image area to be cropped.

- Press the <Q> button.
- ▶ The image area to be cropped will be displayed.
- Press the <Q> button again to return to the original image.

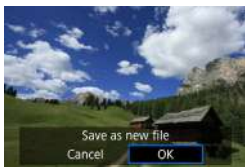

5 Save the cropped image.

- Press <SET> and select [OK] to save the cropped image.
- Check the destination folder and image number, then select [OK].
- To crop another image, repeat steps 2 to 4.

- Once a cropped image is saved, it cannot be cropped again or resized.
- AF point display information (p.351) and Dust Delete Data (p.403) will not be appended to the cropped images.
- Depending on the image and the size it is cropped to, the cropped image file may not be smaller than the original.

11

Sensor Cleaning

The camera has a Self Cleaning Sensor Unit to automatically shake off dust adhered to the image sensor's front layer (low pass filter).

The Dust Delete Data can also be appended to the image so that the dust spots remaining can be deleted automatically by Digital Photo Professional (EOS software, p.550).

Smudges adhering to the front of the sensor

Besides dust entering the camera from outside, in rare cases, lubricant from the camera's internal parts may adhere to the front of the sensor. If visible spots still remain after the automatic sensor cleaning, having the sensor cleaned by a Canon Service Center is recommended.

Automatic Sensor Cleaning

Whenever you set the power switch to <ON/LOCK> or <OFF>, the Self Cleaning Sensor Unit is activated to automatically shake off the dust on the front of the sensor. Normally, you need not pay attention to this operation. However, you can manually perform sensor cleaning or can disable this unit as follows.

Cleaning the Sensor Now



1 Select [Sensor cleaning].

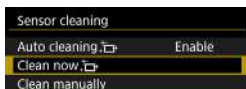

- Under the [ 3] tab, select [**Sensor cleaning**], then press <SET>.



2 Select [Clean now].

- Select [**Clean now **], then press <SET>.
- Select [**OK**].

- ▶ The screen will indicate that the sensor is being cleaned. (A small sound may be heard.) Although there will be a mechanical sound of the shutter, no picture is taken.
- ▶ After sensor cleaning is finished, the camera will automatically turn off and on.

-  • For best results, perform the sensor cleaning with the camera placed upright and stable on a table or other flat surface.
- Even if you repeat the sensor cleaning, the result will not improve much. Immediately after the sensor cleaning is finished, the [**Clean now **] option remains disabled temporarily.
- Dots of light may appear on images if the sensor has been affected by cosmic rays, etc. By selecting [**Clean now **], their appearance may be suppressed (p.518).

Disabling Automatic Sensor Cleaning

- In step 2, select [**Auto cleaning **] and set it to [**Disable**].
- ▶ The sensor cleaning will no longer be performed when you set the power switch to <ON/LOCK> or <OFF>.

MENU Appending Dust Delete Data

Normally, the Self Cleaning Sensor Unit will eliminate most of the dust that may be visible on captured images. However, in case visible dust still remains, you can append the Dust Delete Data to the image for erasing the dust spots later. The Dust Delete Data is used by Digital Photo Professional (EOS software, p.550) to erase the dust spots automatically.

Preparation

- Prepare a solid white object such as a sheet of paper.
- Set the lens focal length to 50 mm or longer.
- Set the lens's focus mode switch to **<MF>** and set the focus to infinity (∞). If the lens has no distance scale, rotate the camera to face toward you and turn the focusing ring clockwise all the way.

Obtaining the Dust Delete Data

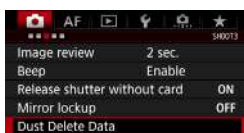

1 Select [Dust Delete Data].

- Under the [**3**] tab, select [**Dust Delete Data**], then press **<SET>**.



2 Select [OK].

- ▶ After the automatic self-cleaning of the sensor is performed, a message will appear. Although there will be a mechanical sound of the shutter, during the cleaning, no picture is taken.

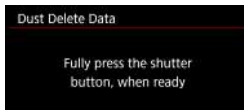
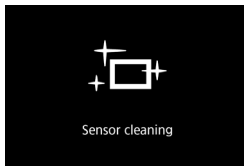



3 Shoot a solid-white object.

- At a distance of 20 cm - 30 cm (0.7 ft. - 1.0 ft.), fill the viewfinder with a patternless, solid-white object and take a picture.
- ▶ The picture will be taken in aperture-priority AE mode at an aperture of f/22.
- Since the image will not be saved, the data can still be obtained even if there is no card in the camera.
- ▶ When the picture is taken, the camera will start collecting the Dust Delete Data. When the Dust Delete Data is obtained, a message will appear.
- If the data is not obtained successfully, an error message will appear. Follow the "Preparation" procedure on the preceding page, then select [OK]. Take the picture again.

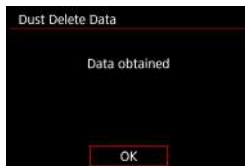

Dust Delete Data

After the Dust Delete Data is obtained, it is appended to all the JPEG and RAW images captured thereafter. Before an important shoot, it is recommended that you update the Dust Delete Data by obtaining it again. For details about using Digital Photo Professional (EOS software, p.550) to erase dust spots, refer to the Digital Photo Professional Instruction Manual (p.4).

The Dust Delete Data appended to the image is so small that it hardly affects the image file size.

! Be sure to use a solid-white object such as a new sheet of white paper. If the object has any pattern or design, it may be recognized as dust data and affect the accuracy of the dust deletion with the Digital Photo Professional (EOS software).

MENU Manual Sensor Cleaning

Dust that could not be removed by the automatic sensor cleaning can be removed manually with a commercially-available blower, etc. Before cleaning the sensor, detach the lens from the camera.

The image sensor is extremely delicate. If the sensor needs to be cleaned directly, having it done by a Canon Service Center is recommended.

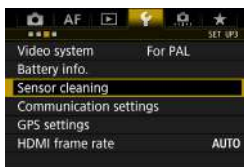

1 Select [Sensor cleaning].

- Under the [**3**] tab, select [**Sensor cleaning**], then press <SET>.

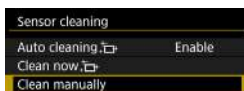

2 Select [Clean manually].



3 Select [OK].

- ▶ In a moment, the reflex mirror will lock up and the shutter will open.
- “CLn” will blink on the top LCD panel.

4 Clean the sensor.

5 End the cleaning.

- Set the power switch to <OFF>.



If you use a battery, make sure it is fully charged.



It is recommended to use household power outlet accessories (sold separately, p.483).

- **While cleaning the sensor, never do any of the following. If the power is cut off, the shutter will close and the shutter curtains and image sensor may get damaged.**
 - **Setting the power switch to <OFF>.**
 - **Removing or inserting the battery.**
- The surface of the image sensor is extremely delicate. Clean the sensor with care.
- Use a plain blower without any brush attached. A brush can scratch the sensor.
- Do not insert the blower tip inside the camera beyond the lens mount. If the power is turned off, the shutter will close and the shutter curtains or reflex mirror may get damaged.
- Never use pressurized air or gas to clean the sensor. Pressurized air may damage the sensor, and sprayed gas may freeze on the sensor and scratch it.
- If the battery level becomes low while cleaning the sensor, the beeper will sound as a warning. Stop cleaning the sensor.
- If a smudge that cannot be removed with a blower remains, having the sensor cleaned by a Canon Service Center is recommended.

12

Transferring Images to a Computer and Print Ordering

- **Transferring Images to a Computer** (p.408)
You can connect the camera to a computer and operate the camera alone to transfer images recorded on the card to the computer.
- **Digital Print Order Format (DPOF)** (p.413)
DPOF (Digital Print Order Format) enables you to print images recorded on the card according to your printing instructions such as the image selection, quantity to print, etc. You can print multiple images in one batch or create a print order for a photofinisher.

Transferring Images to a Computer

You can connect the camera to a computer and operate the camera to transfer images on the card to the computer. This is called direct image transfer.

You can perform the direct image transfer with the camera while looking at the LCD monitor.

The images transferred to the computer will be saved in the [Pictures] or [My Pictures] folder and organized in folders by shooting date.

 Before connecting the camera to a computer, install EOS Utility (EOS software) to your computer (p.550-551).

Preparing Image Transfer

1 Set the camera's power switch to <OFF>.

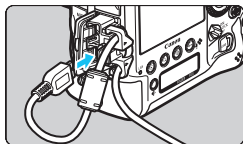

2 Connect the camera to a computer.

- Use the interface cable provided with the camera.
- When connecting the cable to the camera, use the cable protector (p.38). Connect the cable to the digital terminal with the plug's <SS>> icon facing the back of the camera.
- Connect the cord's plug to the computer's USB terminal.

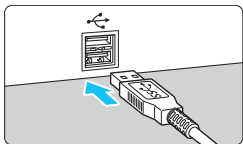

 Use the provided interface cable or one from Canon (p.485). When connecting the interface cable, use the provided cable protector (p.38).

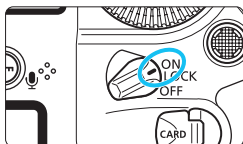

3 Set the power switch to <ON>.

- When the computer displays a screen to select the program, select [**EOS Utility**].
- ▶ The EOS Utility screen will appear on the computer.

ⓘ After the EOS Utility screen appears, do not operate EOS Utility. If any screen other than EOS Utility's main window is displayed, [**Direct transfer**] in step 5 on page 411 will not be displayed. (You cannot transfer images to the computer.)

- If the EOS Utility screen does not appear, refer to the EOS Utility Instruction Manual (p.4).
- Before disconnecting the cable, turn off the camera. Hold the plug (not the cord) to pull out the cable.
- You can also transfer images to an FTP server via a wired LAN connected to the Ethernet RJ-45 terminal (p.28). For details, refer to the "Wired LAN Instruction Manual" (p.4).

MENU Transferring RAW+JPEG Images

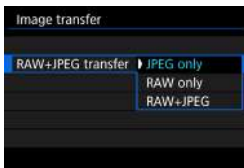

For RAW+JPEG images, you can specify which image to transfer. On the next page in step 2, select [**RAW+JPEG transfer**], then select the image to be transferred: [**JPEG only**], [**RAW only**], or [**RAW+JPEG**].

ⓘ This [**RAW+JPEG transfer**] setting is linked to the [**RAW+JPEG transfer**] setting under [**3: Communication settings**] → [**Network settings**] → [**Function settings**] → [**FTP transfer settings**] → [**Transfer type/size**], and the two will always remain synchronized.

MENU Selecting the Images to be Transferred

Sel.Image

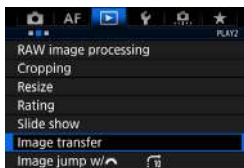

1 Select [Image transfer].

- Under the [▶2] tab, select [Image transfer], then press <SET>.

2 Select [Image sel./transfer].

3 Select [Sel.Image].

4 Select the images to be transferred.

- Turn the <◉> dial to select the image to be transferred, then press <SET>.
- Turn the <◉> dial to display the [✓] on the screen's upper left, then press <SET>.
- If you press the <Q> button and turn the <⚙> dial counterclockwise, you can select an image from a three-image display. To return to the single-image display, turn the <⚙> dial clockwise.
- To select another image to be transferred, repeat step 4.

- When [Sel.Image] is selected, you can check the image's transfer status on the upper left of the screen: No mark: Not selected. ✓: Selected for transfer. ✗: Transfer failed. ○: Transfer succeeded.
- The procedures for [RAW+JPEG transfer] (p.409) and steps 1 to 4 above can also be performed while the camera is not connected to a computer.



5 Transfer the image.

- On the computer screen, check that EOS Utility's main window is displayed.
- Select [**Direct transfer**], then press <SET>.
- On the confirmation dialog, select [**OK**] to transfer the images to the computer.
- Images selected with [**Sel. [Folder]**] and [**All image**] can also be transferred in this way.

• Sel. [Folder]

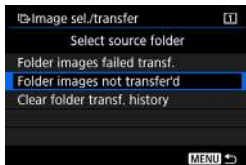

Select [**Sel. [Folder]**] and select [**Folder images not transfer'd**]. When you select a folder, all the images in that folder not yet transferred to the computer will be selected.

Selecting [**Folder images failed transf.**] will select the selected folder's images that failed to transfer.

Selecting [**Clear folder transf. history**] will clear the transfer history of the images in the selected folder. After clearing the transfer history, you can select [**Folder images not transfer'd**] and transfer all the images in the folder again.

● All image

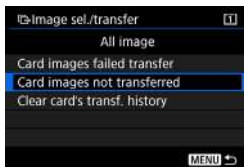

If [**All image**] is selected and you select [**Card images not transferred**], all the images on the card not yet transferred to a computer will be selected.

For a description of [**Card images failed transfer**] and [**Clear card's transf. history**], see “Sel. 

- If any screen other than EOS Utility's main window is displayed on the computer, [**Direct transfer**] is not displayed.
- During the image transfer, certain menu options cannot be used.

- You can also transfer movies.
- Up to 9,999 images can be transferred in one batch.
- When transferring an image having a voice memo, the voice memo will also be transferred.
- Shooting is possible during the image transfer.
- For [**Transfer with caption**] under [**2: Image transfer**], see the “Wired LAN Instruction Manual” (p.4).

Digital Print Order Format (DPOF)

DPOF (Digital Print Order Format) enables you to print images recorded on the card according to your printing instructions such as the image selection, quantity to print, etc. You can print multiple images in one batch or create a print order for a photofinisher.

You can set the print settings such as print type, date imprinting, file number imprinting, etc. The print settings will be applied to all print-ordered images. (They cannot be set individually for each image.)

Setting the Printing Options

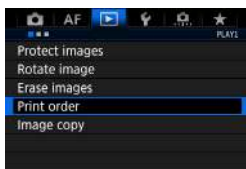

1 Select [Print order].

- Under the [▶1] tab, select [Print order], then press <SET>.

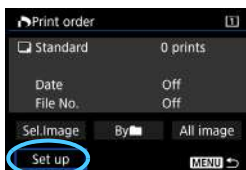

2 Select [Set up].

3 Set the options as desired.

- Set the [Print type], [Date], and [File No.].
- Select the option to be set, then press <SET>. Select the desired setting, then press <SET>.

Print type

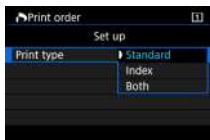

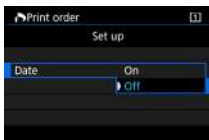

Date

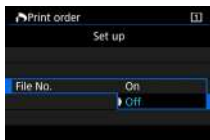

File No.



Print type	 Standard	Prints one image on one sheet.
	 Index	Multiple thumbnail images are printed on one sheet.
	 Both	Prints both the standard and index prints.
Date	On	[On] imprints the recorded date on the print.
	Off	
File number	On	[On] imprints the file number on the print.
	Off	

4 Exit the setting.

- Press the <MENU> button.
- ▶ The print order screen will reappear.
- Next, select [**Sel. Image**], [**By ■■**], or [**All image**] to order the images to be printed.

- RAW images and movies cannot be print ordered.
- If you print an image with a large image size using the [**Index**] or [**Both**] setting (p.415), the index print may not be printed with certain printers. In such a case, resize the image (p.397), then print the index print.
- Even if [**Date**] and [**File No.**] are set to [**On**], the date or file number may not be imprinted, depending on the print type setting and printer.
- With [**Index**] prints, the [**Date**] and [**File No.**] cannot both be set to [**On**] at the same time.
- When printing with DPOF, use the card whose print order specifications are set. It cannot be printed with the specified print order if you just extract images from the card and try to print them.
- Certain DPOF-compliant printers and photofinishers may not be able to print the images as you specified. Refer to the printer's Instruction Manual before printing, or check with your photofinisher about compatibility when ordering prints.
- Do not specify a new print order for a card containing images whose print order was set by a different camera. All the print orders may be overwritten inadvertently. Also, the print order may not be possible, depending on the image type.

Specifying Images for Printing

● Sel.Image

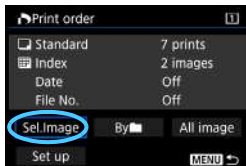

Select and order images one by one. If you press the <Q> button and turn the <☺> dial counterclockwise, you can select an image from a three-image display. To return to the single-image display, turn the <☺> dial clockwise. Press the <MENU> button to save the print order to the card.

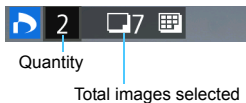

● Standard / Both

Press <SET> to print a copy of the displayed image. By turning the <☺> dial, you can set the number of copies to be printed up to 99.



● Index

Press <SET> to add a checkmark to the box [✓]. The image will be included in the index print.

● By [Folder]

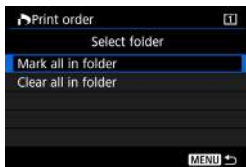

Select [**Mark all in folder**] and select the folder. A print order for one copy of all the images in the folder will be specified. If you select [**Clear all in folder**] and select the folder, the print order for all the images in the folder will be canceled.

● All image

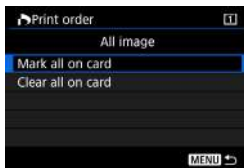

If you select [**Mark all on card**], one copy of all the images on the card will be set for printing.

If you select [**Clear all on card**], the print order will be cleared for all the images on the card.

 Note that RAW images and movies will not be included in the print order even if you set [**By ■■■**] or [**All image**].



13

Customizing the Camera

You can make fine adjustments to various camera functions and change the functionality of buttons and dials to suit your picture-taking preferences with Custom Functions and Custom Controls. You can also save the current camera settings to a card or register them under the <C1>, <C2>, or <C3> shooting mode.

MENU Custom Functions

☛ 1: Exposure

		 LV Shooting	 Movie Shooting
Exposure level increments	p.421	<input type="radio"/>	<input type="radio"/>
ISO speed setting increments		<input type="radio"/>	In M
Bracketing auto cancel	p.422	<input type="radio"/>	
Bracketing sequence		<input type="radio"/>	
Number of bracketed shots	p.423	<input type="radio"/>	
Spot metering link to AF point			

☛ 2: Exposure



Safety shift	p.424	<input type="radio"/>	
Same exposure for new aperture	p.425	<input type="radio"/>	

☛ 3: Exposure

Restrict shooting modes	p.427	<input type="radio"/>	<input type="radio"/>
Restrict metering modes		<input type="radio"/>	
Metering used in manual exposure			
Set shutter speed range	p.428	<input type="radio"/>	<input type="radio"/>
Set aperture range		<input type="radio"/>	<input type="radio"/>
AE Microadjustment	p.429	<input type="radio"/>	<input type="radio"/>
FE Microadjustment	p.430	<input type="radio"/>	

 Shaded Custom Functions do not function during Live View (LV) shooting or movie shooting. (Settings are disabled.)



4: Drive

		 LV Shooting	 Movie Shooting
Continuous shooting speed	p.431	<input type="radio"/>	
Limit continuous shot count	p.432	<input type="radio"/>	
Restrict drive modes		<input type="radio"/>	



5: Display/Operation

Focusing screen	p.433		
Viewfinder info. during exposure	p.434		
LCD panel illumination during Bulb		<input type="radio"/>	
Recording card, image size setting	p.435	<input type="radio"/>	<input type="radio"/>

6: Operation

Warnings  in viewfinder	p.436		
Dial direction during Tv/Av		<input type="radio"/>	<input type="radio"/>
Av setting without lens	p.437	<input type="radio"/>	<input type="radio"/>
Multi function lock		<input type="radio"/>	<input type="radio"/>
Custom Controls		Depends on setting	
 /  button function	p.438	(During playback)	

7: Others

		 LV Shooting	 Movie Shooting
Add cropping information	p.439	<input type="radio"/>	
Timer duration	p.440	*1	
Shutter release time lag			
Memo audio quality	p.441		
Default Erase option		(During playback)	
Retract lens on power off	p.442	<input type="radio"/>	<input type="radio"/>

*1: [Timer after release] only

8: Clear

Selecting [**8: Clear all Custom Func. (C.Fn)**] will clear all the Custom Function settings.

 Even if [**8: Clear all Custom Func.(C.Fn)**] is performed, the settings for [**5: Focusing screen**] and [**6: Custom Controls**] will remain unchanged. Although the [**3: AE Microadjustment**] and [**3: FE Microadjustment**] settings will not be cleared, [**Disable**] will be set.

MENU Custom Function Settings

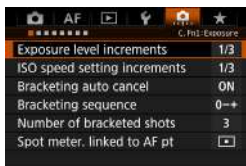

Under the [] tab, you can customize various camera features to suit your picture-taking preferences. Any settings different from the default will be displayed in blue.

C.Fn1: Exposure

Exposure level increments

C.Fn1

1/3: 1/3-stop, Exposure compensation 1/3-stop

Sets 1/3-stop increments for the shutter speed, aperture, exposure compensation, AEB level, and flash exposure compensation.

1/1: 1-stop, Exposure compensation 1/3-stop

Sets whole-stop increments for the shutter speed and aperture, and 1/3-stop increments for exposure compensation, AEB level, and flash exposure compensation.

1/2: 1/2-stop, Exposure compensation 1/2-stop

Sets 1/2-stop increments for the shutter speed, aperture, exposure compensation, AEB level, and flash exposure compensation.



When [**1/2-stop, Exposure compensation 1/2-stop**] is set, the exposure level will be displayed as shown below.



ISO speed setting increments

C.Fn1

1/3: 1/3-stop

You can set the ISO speed manually in 1/3-stop increments.

1/1: 1-stop

You can set the ISO speed manually in 1-stop increments.



Even if [**1-stop**] is set, ISO speed will be automatically set in 1/3-stop increments when ISO Auto is set.

Bracketing auto cancel

C.Fn1

ON: Enable

When you set the power switch to <OFF>, the AEB and white balance bracketing settings will be canceled. AEB will also be canceled when the flash is ready to fire or if you switch to movie shooting.

OFF: Disable

The AEB and white balance bracketing settings will not be canceled even if you set the power switch to <OFF>. (If the flash is ready to fire or if you switch to movie shooting, AEB will be canceled temporarily, but the AEB range will be retained.)

Bracketing sequence

C.Fn1

The AEB shooting sequence and white balance bracketing sequence can be changed.

0-+: 0, -, +

-0+: -, 0, +

+0-: +, 0, -

AEB	White Balance Bracketing	
	B/A Direction	M/G Direction
0 : Standard exposure	0 : Standard white balance	0 : Standard white balance
- : Decreased exposure	- : Blue bias	- : Magenta bias
+ : Increased exposure	+ : Amber bias	+ : Green bias

Number of bracketed shots

C.Fn1

The number of shots taken with AEB and white balance bracketing can be changed from the default 3 shots, to 2, 5, or 7 shots.

When [MENU 1: Bracketing sequence: 0, -, +] is set, the bracketed shots will be taken as shown in the table below.

3: 3 shots**5: 5 shots****2: 2 shots****7: 7 shots**

(1-stop/step increments)

	1st Shot	2nd Shot	3rd Shot	4th Shot	5th Shot	6th Shot	7th Shot
3: 3 shots	Standard (0)	-1	+1				
2: 2 shots	Standard (0)	±1					
5: 5 shots	Standard (0)	-2	-1	+1	+2		
7: 7 shots	Standard (0)	-3	-2	-1	+1	+2	+3



If [2 shots] is set, you can select the + or - side when setting the AEB range. With WB bracketing, the 2nd shot will be adjusted toward the minus direction for either B/A or M/G.

Spot metering link to AF point

C.Fn1

You can enable AF point-linked spot metering in the <[AF Point] > shooting mode.

 Center AF point only

Regardless of the AF area selection mode and selected AF point, the spot metering will always be performed at the viewfinder center.

 Linked to active AF point

Spot metering will be linked to the manually-selected AF point. If the AF area selection mode has been set to Automatic selection AF, Zone AF, or Large Zone AF, spot metering will be performed at the viewfinder center.

With an external Speedlite, you can use FE lock linked to a manually selected AF point. (You can also use it for metered manual flash exposure (p.262).)

C.Fn2: Exposure

Safety shift

C.Fn2

OFF: Disable

Tv/Av: Shutter speed/Aperture

Takes effect in the shutter-priority AE <Tv> and aperture-priority AE <Av> modes. If the subject brightness changes and the standard exposure cannot be obtained within the autoexposure range, the camera will automatically change the manually-selected setting to obtain the standard exposure.

ISO: ISO speed

Works in the Program AE <P>, shutter-priority AE <Tv>, and aperture-priority AE <Av> modes. If the subject brightness changes and the standard exposure cannot be obtained within the autoexposure range, the camera will automatically change the manually set ISO speed to obtain the standard exposure.

If [ISO speed] is set, the camera's internal temperature is low, and the safety shift sets the ISO speed to ISO 32000 or higher automatically, the maximum continuous shooting speed will decrease (except when you use AC Adapter Kit ACK-E4). For details, see page 148.

- When [ISO speed] is set, safety shift will also work with AEB shooting in the <M> mode.
- Under [C2: ISO speed settings], even if [Range for stills] or [Min. shutter spd.] is changed from the default setting, safety shift will override it if the standard exposure cannot be obtained.
- The minimum and maximum ISO speeds of the safety shift using the ISO speed will be determined by the [Auto range] setting (p.167). However, if the manually set ISO speed exceeds the [Auto range], the safety shift will take effect up or down to the manually set ISO speed.
- Safety shift will take effect if necessary even when flash is used.

Same exposure for new aperture

C.Fn2

If the **<M>** mode (manual exposure shooting) is set and the ISO speed is set manually (except when set to ISO Auto), the open aperture value may change to a higher number (a smaller aperture) if you perform any of the following: 1. Change the lens, 2. Attach an Extender, or 3. Use a zoom lens whose open aperture value (f/number) changes. If you then shoot while the maximum aperture is set, the image will be underexposed by the amount the maximum aperture f/number changes to a higher number. However, by changing the ISO speed or shutter speed (Tv) automatically, you can obtain the same exposure that would be obtained without performing 1, 2, or 3.

OFF: Disable

Automatic changes in settings to maintain the specified exposure will not be applied. The ISO speed, shutter speed, and aperture already set will be used for shooting. If you perform 1, 2, or 3 and the maximum aperture becomes slower, adjust the ISO speed and shutter speed before you shoot.

ISO: ISO speed

If you perform 1, 2, or 3, a higher ISO speed will be set automatically to compensate for the number of stops the maximum aperture has become slower. The same exposure that would be obtained without performing 1, 2, or 3 is thereby obtained. The ISO speed will change automatically within the range set with **[Range for stills]**.



ISO/Tv: ISO speed/Shutter speed

If you perform 1, 2, or 3, a higher ISO speed will be set automatically to compensate for the number of stops the maximum aperture has become slower. If the ISO speed reaches the upper limit of the range set with **[Range for stills]**, a slower shutter speed will be set automatically. The same exposure that would be obtained without performing 1, 2, or 3 is thereby obtained. The shutter speed will change automatically within the range set with **[3: Set shutter speed range]**.

Tv: Shutter speed

If you perform 1, 2, or 3, a slower shutter speed will automatically be set to compensate for the number of stops the maximum aperture has become slower. The same exposure that would be obtained without performing 1, 2, or 3 is thereby obtained. The shutter speed will change automatically within the range set with [ **3: Set shutter speed range**].

This function also works in the reverse of the above: When the maximum aperture f/number changes to a smaller number (larger aperture opening).

-  • This function does not work with macro lenses whose effective aperture value changes when the magnification changes.
- This function does not work during movie shooting.
- If [**ISO speed**] is set and the exposure cannot be maintained within the range set with [**Range for stills**], the same exposure that would be obtained without performing 1, 2, or 3 cannot be obtained.
- If [**Shutter speed**] is set and the exposure cannot be maintained within the range set with [ **3: Set shutter speed range**], the same exposure that would be obtained without performing 1, 2, or 3 cannot be obtained.
- If you perform 1, 2, or 3 and the camera turns off (power switch is set to <OFF>, etc.) while the exposure is being maintained, the standard exposure will be updated to the exposure at the moment the camera turns off.

-  • This function also works with changes in the highest f/number (minimum aperture).
- With [**ISO speed**] or [**Shutter speed**] set, if you perform 1, 2, or 3 and then return to the state before performing 1, 2, or 3 without manually changing the ISO speed, shutter speed, or aperture, the original exposure setting will be restored.
- If [**ISO speed**] is set and the ISO speed increases to an expanded ISO speed, the shutter speed may change to maintain the exposure.

C.Fn3: Exposure

Restrict shooting modes

C.Fn3

You can restrict the shooting modes selectable with the <MODE> button.

Select a shooting mode <P>/<Av>/<M>/<Tv>/<BULB>/<C1>/<C2>/<C3>, then press <SET> to add a checkmark <✓>. Then select [OK] to register the setting.



- The restricted shooting mode settings are not registered to <C1>, <C2>, or <C3>.
- You cannot remove the [✓] mark for all eight modes.

Restrict metering modes

C.Fn3

You can restrict the metering modes selectable with the <Fn2>•<Fn3> button.

Select a metering mode <☉> <☺> <☛> <☞>, then press <SET> to add a checkmark <✓>. Then select [OK] to register the setting.



- You cannot remove the [✓] mark for all four modes.

Metering used in manual exposure

C.Fn3

You can set the metering mode to be used in the <M> shooting mode.

✓☉: Specified metering mode

The currently-set metering mode is used.

☉: Evaluative metering

☺: Partial metering

☛: Spot metering

☞: Center-weighted average metering



- If <☉> <☺> <☛> <☞> is set, pressing the <Fn2>•<Fn3> button during manual exposure shooting will not select the metering mode.

Set shutter speed range

C.Fn3

You can set the shutter speed range. In the <**Tv**> and <**M**> modes, you can set the shutter speed manually within the range you have set. In the <**P**> and <**Av**> modes, the shutter speed will be set automatically within the set shutter speed range (except for movie shooting). Then select [**OK**] to register the setting.

Highest speed

You can set it from 1/8000 sec. to 15 sec.

Lowest speed

You can set it from 30 sec. to 1/4000 sec.

Set aperture range

C.Fn3

You can set the aperture range. In the <**Av**>, <**M**>, and <**bulb**> modes, you can set the aperture manually within the range you have set. In the <**P**> and <**Tv**> modes, the aperture will be set automatically within the set aperture range (except for movie shooting). Then select [**OK**] to register the setting.

Min. aperture (Max. f/)

You can set it from f/9.1 to f/1.4.

Max. aperture (Min. f/)

You can set it from f/1.0 to f/64.

 The settable aperture range varies depending on the lens's maximum and minimum apertures.

AE Microadjustment

C.Fn3

 Normally, this adjustment is not required. Perform this adjustment only if necessary. Note that performing this adjustment may prevent obtaining an accurate exposure.

You can fine-tune the standard exposure level. The adjustment can help if the camera's "standard exposure level" always seems to be underexposed or overexposed.

OFF: Disable

ON: Enable

Select [**Enable**], then press the <Q> button. The adjustment screen will appear. The adjustment can be made up to ± 1 stop in 1/8-stop increments. If the shot images tend to be underexposed, set it to the plus side. If they tend to be overexposed, set it to the minus side.

 Even if you use AE Microadjustment to adjust the standard exposure level, the effective exposure compensation range you can set for movie shooting remains unchanged while the standard exposure level alone will be changed. For movie shooting, if the effective exposure compensation range is exceeded, the exposure compensation amount equivalent to the AE Microadjustment amount will not be reflected in the resulting image. (Example: If AE Microadjustment is set to +1 stop and exposure compensation is set to +3 stops, an exposure compensation amount of +1 stop will not be applied.)

 For viewfinder shooting or Live View shooting, you can set exposure compensation up to ± 5 stops from the adjusted standard exposure.

FE Microadjustment

C.Fn3

 Normally, this adjustment is not required. Perform this adjustment only if necessary. Note that doing this adjustment may prevent obtaining the correct flash exposure.

You can fine adjust the camera's standard flash exposure level. The adjustment can help if the camera's "standard flash exposure level" (without flash exposure compensation) always seems to underexpose or overexpose the subject.

OFF: Disable







ON: Enable

Select [**Enable**], then press the <[Q]> button. The adjustment screen will appear. The adjustment can be made up to ± 1 stop in 1/8-stop increments. If the flash exposure level tends to underexpose the subject, set it to the plus side. If it tends to overexpose, set it to the minus side.

C.Fn4: Drive

Continuous shooting speed

C.Fn4

You can set the continuous shooting speed for <  > High-speed continuous shooting, <  > Low-speed continuous shooting, <   > Silent high-speed continuous shooting, and <   > Silent low-speed continuous shooting. Then select [OK] to register the setting.

High speed

The default setting is 14 fps. For viewfinder shooting, you can set 2 fps to 14 fps. For Live View shooting, you can set 2 fps to 14 fps or 16 fps. The “(16)” indicates the continuous shooting speed for Live View shooting.

Low speed

The default setting is 3 fps. You can set it from 1 to 13 fps.

Silent HS continuous

The default setting is 5 fps. You can set it from 2 to 5 fps.

Silent LS continuous

The default setting is 3 fps. You can set it from 1 to 4 fps.



- For viewfinder shooting, if the ISO speed is H1 (equivalent to ISO 102400) or higher (ISO 32000 or higher if the camera's internal temperature is low), the maximum continuous shooting speed will be approx. 10.0 fps even if [High speed] is set to [14 (16) fps] - [11 fps] or [Low speed] is set to [13 fps] - [11 fps]. (With AC Adapter Kit ACK-E4, the maximum continuous shooting speed will be approx. 8.0 fps regardless of the ISO speed (p.148).)
- For Live View shooting, if the ISO speed is H1 (equivalent to ISO 102400) or higher (ISO 32000 or higher if the camera's internal temperature is low), the maximum continuous shooting speed will be approx. 14.0 fps even if [High speed] is set to [14 (16) fps]. (With ACK-E4, the maximum continuous shooting speed will be approx. 14.0 fps regardless of the ISO speed. (p.148).)
- If you use a Speedlite with Live View shooting and set [High speed] to [14 (16) fps], the flash will not be fired during high-speed continuous shooting.
- If [ 3: Anti-flicker shoot.] is set to [Enable] (p.198), you may not be able to shoot at the continuous shooting speed you have set.

Limit continuous shot count

C.Fn4

You can limit the maximum burst for continuous shooting. With continuous shooting set, while you keep holding down the shutter button, the camera automatically stops shooting after the set number of continuous shots is taken.

You can set it from 2 to 99 exposures. Pressing the $\langle \text{LIMIT} \rangle$ button will return the setting to [Disable].

If [Disable] is set, continuous shooting can continue up to the maximum burst displayed on the right side of the viewfinder.

Restrict drive modes

C.Fn4

You can restrict the drive modes selectable with the $\langle \text{DRIVE} \cdot \text{AF} \rangle$ button.

Select a drive mode $\langle \text{□} \rangle$ $\langle \text{□}_H \rangle$ $\langle \text{□}_L \rangle$ $\langle \text{□}_S \rangle$ $\langle \text{□}_H^S \rangle$ $\langle \text{□}_L^S \rangle$ $\langle \text{□}^{10} \rangle$ $\langle \text{□}_2 \rangle$, then press $\langle \text{SET} \rangle$ to add a checkmark $\langle \checkmark \rangle$. Then select [OK] to register the setting.

 You cannot remove the [✓] mark for all eight modes.

C.Fn5: Display/Operation

Focusing Screen



C.Fn5

You can change the focusing screen with an Ec-series focusing screen (sold separately) more suited for the techniques in the photography.

If you change the focusing screen, make sure to change this setting to match the focusing screen type. This is to obtain a correct exposure.

Std.:  Ec-C6

Standard focusing screen.

 :  Ec-A, B, L

For Laser-matte screens.



- Since the Ec-A/B/L focusing screens have a prism at the center, correct exposures cannot be obtained with evaluative metering and spot metering at the center. Use either center-weighted average metering or AF point-linked spot metering (except for at the center).
- Since the Ec-A/B/L focusing screens have a prism in the center, AF based on color or facial information may not be achieved if the subject is near the center of the viewfinder, even if [**AF4: Auto AF pt sel.: EOS iTR AF**] is set to [**EOS iTR AF (Face priority)**] or [**EOS iTR AF**] (p.127).
- Although an Ec-C/CII/CIII/CIV/CV/D/H/II/N/R/S focusing screen can be installed in the camera, the correct exposure will not be obtained. Use a commercially-available light meter to shoot with manual exposure or exposure compensation.
- If [**Ec-A, B, L**] is set, the spot metering circle will not be displayed at the viewfinder center.
- The Area AF frame displayed on the Ec-CIII/CIV/N/S focusing screens does not match this camera's AF Area.



- The focusing screen setting will not be cleared even if you select [**8: Clear all Custom Func. (C.Fn)**].
- To change the focusing screen, refer to the Instruction Manual of the focusing screen.

Viewfinder info. during exposure

C.Fn5

For viewfinder shooting, you can set whether to display the shooting information in the viewfinder during the exposure.

OFF: Disable**ON: Enable**

The shooting information will be displayed in the viewfinder even during exposure. This function is useful when you want to check the exposure, possible shots, etc. during continuous shooting.

 When the shooting mode is set to "Bulb", the viewfinder information will not be displayed even if **[Enable]** is set.

LCD panel illumination during Bulb

C.Fn5

You can set how the LCD panel behaves if you start a Bulb exposure with its illumination lit: either to stay on, or to turn off when the exposure starts and light up for a short period if the <:ⓘ:> button is pressed.

OFF: Off

When the Bulb exposure starts, the LCD panel illumination turns off. Pressing the <:ⓘ:> button during a Bulb exposure illuminates the LCD panel for approx. 6 sec.

ON: On during Bulb



The LCD panel illumination remains on until the Bulb exposure ends. This is useful when you are taking a Bulb exposure in low light and want to check the exposure time.

Recording card, image size setting

C.Fn5

When you press the <  > button to select the card or set the image size, you can select to do it with the rear LCD panel or with the LCD monitor.



 **Rear LCD panel**

You can press the <  > button, then turn the <  > or <  > dial while looking at the rear LCD panel.

 **LCD monitor**

When you press the <  > button, the [Img type/size] or [Record func+card/folder sel.] screen will appear. Pressing the button toggles between the two screens.

OFF: Disable  button

You cannot select the card or set the image size by pressing the <  > button. It can prevent the image size or recording card from changing when the <  > button is pressed accidentally. Select the card or set the image size from the menu screen.

C.Fn6: Operation

Warnings in viewfinder

C.Fn6

When any of the following functions are set, the  icon can be displayed in the viewfinder (p.30).

Select the function for which you want the warning icon to appear, then press  to add a checkmark [✓]. Then select [OK] to register the setting.

When monochrome is set

If the Picture Style is set to [Monochrome] (p.170), the warning icon will appear.

When WB is corrected

If white balance correction is set (p.186), the warning icon will appear.

When one-touch image quality is set

If you change the image-recording quality with the one-touch image quality setting function (p.455), the warning icon will appear.

When spot metering is set

If the metering mode is set to  spot metering (p.239), the warning icon will appear.





Dial direction during Tv/Av

C.Fn6

 : Normal

 : Reverse direction

Dial turning direction when setting the shutter speed and aperture can be reversed.

In the **<M>** shooting mode, the turning direction of the  and  dials will be reversed. In other shooting modes, the turning direction of only the  dial will be reversed. The  dial's turning direction in the **<M>** mode and the turning direction to set the exposure compensation in the **<P>**, **<Tv>**, and **<Av>** modes will be the same.

Av setting without lens

C.Fn6

You can set whether the aperture can still be set when no lens is attached to the camera.



OFF: Disable

ON: Enable

You can set the aperture with the camera even while no lens is attached. Convenient when you want to set the aperture in advance when you know which aperture to use.

Multi function lock

C.Fn6

When the power switch is set to <LOCK>, it can prevent the <>, <>, and <> from accidentally changing a setting.

Select the camera control(s) you want to lock with <LOCK>, then press <> to add a checkmark [✓]. Then select [OK] to register the setting.

**Main Dial**

The Main Dial and vertical-grip Main Dial will be locked.



**Quick Control Dial**

The Quick Control Dial will be locked.

**Multi-controller**

The Multi-controller and vertical-grip Multi-controller will be locked.



- If you try to use any of the locked camera controls, <L> will appear in the viewfinder and on the top LCD panel. Also, [LOCK] will appear on the Quick Control screen (p.67) and Custom Quick Control screen (p.461).
- By default, with the power switch is set to <LOCK>, the <> dial will be locked.
- Even if the [✓] is added to lock the <> dial, you can still use the touch pad <>.



Custom Controls

C.Fn6





You can assign often-used functions to camera buttons or dials according to your preferences. For details, see page 443.

 /  button function



C.Fn6



You can change the function of the  /  button. During image playback, you can protect images, record a voice memo, and rate images.





 /  : **Protect (Hold: Record memo)**

To protect an image, press the  /  button. To start recording a voice memo, hold down the  /  button for approx. 2 sec. To end the recording, let go of the button.









 : **Rec. memo (Camera disabled)**





Pressing the  /  button starts recording a voice memo immediately, and letting go of the button ends the recording. To protect an image, use the [ **1: Protect images**] screen.

 /  : **Play memo (Hold: Rec. memo)**

When you play back an image having a voice memo, press the  /  button to hear the voice memo. To start recording a voice memo, hold down the  /  button for approx. 2 sec. To end the recording, let go of the button. To protect an image, use the [ **1: Protect images**] screen.

 : **Rating (Camera and Microphone disabled)**

To rate an image, press the  /  button. Each time you press the button, the rating will change as follows: **OFF**, [], [], [], [], []. To protect an image, use the [ **1: Protect images**] screen.

 If [**Rating (Camera and Microphone disabled)**] is selected and you press the  button, you can set the ratings selectable (usable) with the  /  button.

C.Fn7: Others

Add cropping information

C.Fn7

If you set the cropping information, vertical lines for the aspect ratio you set during the Live View shooting will be displayed on the screen. You can then compose the shot as if you were shooting with a medium- or large-format camera (6x6 cm, 4x5 inch, etc.).

When you take a picture, the aspect ratio information for cropping the image with the Digital Photo Professional (EOS software, p.550) will be appended to the image. (The image is recorded to the card without being cropped.)

If you transfer the image to a computer, you can use Digital Photo Professional to easily crop the image to the aspect ratio that was set at the time of shooting.

- | | |
|-------------------------------------|---------------------------------|
| OFF : Off (aspect ratio 3:2) | 6:7 : Aspect ratio 6:7 |
| 6:6 : Aspect ratio 6:6 | 5:6 : Aspect ratio 10:12 |
| 3:4 : Aspect ratio 3:4 | 5:7 : Aspect ratio 5:7 |
| 4:5 : Aspect ratio 4:5 | |



- Cropping information will also be appended for viewfinder shooting. However, the cropping range will not be displayed.
- Even if a RAW image with cropping information added is processed with the camera (p.392), the JPEG image cannot be saved as a cropped image. When the RAW image is developed, the JPEG image with cropping information will be saved.

Timer duration

C.Fn7

You can change how long a function setting associated with a button remains in effect after you let go of that button. You can set the timer duration within 0 sec. to 59 sec. or within 1 min. to 60 min.

6-sec. timer

You can set how long the metering and AE lock are to be maintained.

16-sec. timer

You can set how long the FE lock and multi-spot metering are to be maintained.

Timer after release

You can set how long the metering is to be maintained after shutter release. Normally, the timer length is approx. 2 sec. after the shutter release. A longer timer length will make it easier to keep using the AE lock for shooting at the same exposure.

Shutter release time lag

C.Fn7

Normally, stabilization control is performed to stabilize the shutter-release time lag. By setting [**Shortened**], this stabilization control can be disabled to make the shutter-release time lag shorter.

| : **Standard**

| : **Shortened**

The shutter-release time lag is normally approx. 0.055 sec. at the shortest. By shortening it, it can be as short as approx. 0.036 sec.

 The shutter-release time lag will vary depending on the shooting conditions, lens type, aperture, etc.

Memo audio quality

C.Fn7

When you record a voice memo, you can set the audio quality.

High quality (48 kHz)

You can record the voice memo at the same audio quality as a movie.

Low quality (8 kHz)

The voice memo's file size is smaller than with [**High quality (48 kHz)**].



If you record another voice memo to an image that already has a voice memo, the audio quality will be the same as the first voice memo regardless of this setting.

Default Erase option

C.Fn7

During image playback and image review immediately after shooting, when you press the < > button, the erase menu appears (p.386). You can set which option, [**Cancel**] or [**Erase**], is to be preselected on this screen.

If [**Erase**] is set, you can just press < > to quickly erase the image.

: [**Cancel**] selected

: [**Erase**] selected



If [**Erase**] is set, be careful not to erase an image accidentally.

Retract lens on power off

C.Fn7

This is to set the lens retraction mechanism for when a gear-driven STM lens (such as EF40mm f/2.8 STM) is attached to the camera. You can set it to retract the extended lens automatically when the camera's power switch is set to <OFF>.

ON : Enable

OFF : Disable

-  With auto power off, the lens will not retract regardless of the setting.
- Before detaching the lens, make sure that it is retracted.

 When [**Enable**] is set, this function takes effect regardless of the lens's focus mode switch setting (AF or MF).

Custom Controls

You can assign often-used functions to camera buttons or dials according to your preferences.

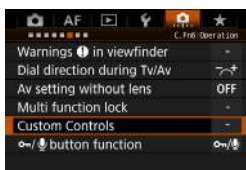

1 Select [Custom Controls].

- Under the [**6**] tab, select [**Custom Controls**], then press **<SET>**.
- ▶ The Custom Controls setting screen will appear.



2 Select a camera button or dial.

- Select a camera button or dial, then press **<SET>**.
- ▶ The name of the camera control and the assignable functions will be displayed.
- ▶ The diagram on the left will show the location of the selected button or dial.



3 Assign a function.

























- Select a function, then press **<SET>**.
- If the [**INFO**] icon appears on the screen's bottom left, you can press the **<INFO>** button and set other related options.





4 Exit the setting.

- When you press **<SET>** to exit the setting, the screen in step 2 will reappear.
- Press the **<MENU>** button to exit.

 With the screen in step 2 displayed, you can press the **<MENU>** button to revert the Custom Control settings to their defaults. Note that the [**6: Custom Controls**] settings will not be canceled even if you select [**8: Clear all Custom Func. (C.Fn)**].































Assignable Functions to Camera Controls





Function		Page		AF-ON	
AF	 AF Metering and AF start	448	<input type="radio"/>	<input type="radio"/> *1	<input type="radio"/> *1
	AF-OFF AF stop	449	<input type="checkbox"/>	<input type="radio"/>	<input type="radio"/>
	AF↔ Switch to registered AF function	450	<input type="checkbox"/>	<input type="checkbox"/>	<input type="checkbox"/>
	<small>ONE SHOT, AI SERVO</small> ONE SHOT ↔ AI SERVO		<input type="checkbox"/>	<input type="radio"/> *3	<input type="radio"/> *3
	 HP Switch to registered AF point		<input type="checkbox"/>	<input type="checkbox"/>	<input type="checkbox"/>
	 AF point direct selection	451	<input type="checkbox"/>	<input type="checkbox"/>	<input type="checkbox"/>
	 Select AF point  ↔  ( during metering)		<input type="checkbox"/>	<input type="checkbox"/>	<input type="checkbox"/>
 Pause Movie Servo AF	452	<input type="checkbox"/>	<input type="checkbox"/>	<input type="checkbox"/>	
Exposure	 Metering start	452	<input type="radio"/>	<input type="checkbox"/>	<input type="checkbox"/>
	 AE lock		<input type="checkbox"/>	<input type="radio"/>	<input type="radio"/>
	 AE lock (while button pressed)		<input type="radio"/>	<input type="checkbox"/>	<input type="checkbox"/>
	 AE lock (hold)		<input type="checkbox"/>	<input type="radio"/>	<input type="radio"/>
	*AF-OFF AE lock, AF stop		<input type="checkbox"/>	<input type="radio"/>	<input type="radio"/>
	FEL FE lock	453	<input type="checkbox"/>	<input type="radio"/>	<input type="radio"/>
	ISO ISO speed		<input type="checkbox"/>	<input type="checkbox"/>	<input type="checkbox"/>
	ISO  Set ISO speed (hold button, turn )		<input type="checkbox"/>	<input type="checkbox"/>	<input type="checkbox"/>
	ISO  Set ISO speed ( during metering)		<input type="checkbox"/>	<input type="checkbox"/>	<input type="checkbox"/>
	 Set ISO,  ↔  ( during metering)		<input type="checkbox"/>	<input type="checkbox"/>	<input type="checkbox"/>
	 Exposure compensation (hold button, turn )		<input type="checkbox"/>	<input type="checkbox"/>	<input type="checkbox"/>
	Tv Shutter speed setting in M mode	454	<input type="checkbox"/>	<input type="checkbox"/>	<input type="checkbox"/>
Av Aperture setting in M mode	<input type="checkbox"/>		<input type="checkbox"/>	<input type="checkbox"/>	

	LENS	M-Fn	M-Fn2	SET			
	<input type="radio"/>						
<input type="radio"/>	<input type="radio"/>		<input type="radio"/>				
<input type="radio"/> *2	<input type="radio"/> *2		<input type="radio"/> *2				
<input type="radio"/> *3	<input type="radio"/> *3		<input type="radio"/> *3				
<input type="radio"/> *4	<input type="radio"/> *4		<input type="radio"/> *4				
						<input type="radio"/> *5	<input type="radio"/> *6
						<input type="radio"/> *7	
<input type="radio"/>			<input type="radio"/>	<input type="radio"/>			
<input type="radio"/>	<input type="radio"/>	<input type="radio"/>	<input type="radio"/>				
<input type="radio"/>	<input type="radio"/>	<input type="radio"/>	<input type="radio"/>				
<input type="radio"/>		<input type="radio"/>	<input type="radio"/>				
				<input type="radio"/>			
				<input type="radio"/>			
						<input type="radio"/>	
						<input type="radio"/>	
				<input type="radio"/>			
					<input type="radio"/>	<input type="radio"/>	
					<input type="radio"/>	<input type="radio"/>	



<LENS> stands for "AF stop button" provided on super telephoto lenses equipped with Image Stabilizer.

Function		Page		AF-ON	
Images	 Image size selection	454			
	 One-touch image quality setting	455			
	 One-touch image quality (hold)				
	 Record function+card/folder selection				
	 Picture Style				
	 White balance selection				
Operation	 Depth-of-field preview	456			
	 IS start				
	 Menu display				
	 Register/recall shooting function				
	 Unlock while button pressed	457			
	 Start movie recording (when  set)				
	 Switch to Custom shooting mode				
	 Image replay				
	 Magnify/Reduce (press SET, turn )				
	 Magnify/Reduce button				
	 Playback button				
	 Info button		458		
	 Erase button				
	 Protect button				
	 Cycle between the set functions				
 Flash function settings					
 No function (disabled)					

	LENS	M-Fn	M-Fn2	SET			
				<input type="radio"/>			
<input type="radio"/> *8		<input type="radio"/> *8	<input type="radio"/> *8				
<input type="radio"/> *8		<input type="radio"/> *8	<input type="radio"/> *8				
				<input type="radio"/>			
				<input type="radio"/>			
				<input type="radio"/>			
<input type="radio"/>			<input type="radio"/>				
<input type="radio"/>	<input type="radio"/>		<input type="radio"/>				
				<input type="radio"/>			
<input type="radio"/>			<input type="radio"/>				
<input type="radio"/>		<input type="radio"/>	<input type="radio"/>	<input type="radio"/>			
		<input type="radio"/>					
				<input type="radio"/>			
				<input type="radio"/>			
<input type="radio"/>			<input type="radio"/>				
<input type="radio"/>			<input type="radio"/>				
<input type="radio"/>			<input type="radio"/>				
<input type="radio"/>			<input type="radio"/>				
<input type="radio"/>			<input type="radio"/>				
		<input type="radio"/> *10					
				<input type="radio"/>			
<input type="radio"/>		<input type="radio"/>	<input type="radio"/>	<input type="radio"/>	<input type="radio"/>	<input type="radio"/>	<input type="radio"/>



<LENS> stands for "AF stop button" provided on super telephoto lenses equipped with Image Stabilizer.

AF: Metering and AF start

When you press the button assigned to this function, metering and AF are performed.

*1: When assigned to the <AF-ON> or <★> button, pressing the <INFO.> button while the setting screen is displayed will enable you to set the detailed AF settings. When shooting, pressing the <AF-ON> or <★> button will perform AF as it was set.



● AF start position

When [**Registered AF point**] is set, you can press the <AF-ON> or <★> button to switch to the registered AF point.

Registering the AF Point

1. Set the AF area selection mode to one of the following: Single-point Spot AF (manual selection), Single-point AF (manual selection), AF point expansion (manual selection ⦿), AF point expansion (manual selection, surrounding points), or Automatic selection AF. Zone AF and Large Zone AF cannot be selected.
2. Select an AF point manually.
3. Hold down the <INFO.> button, then press the <ISO> button. A beep will sound, and the AF point will be registered. If the AF area selection mode is set to any setting other than Automatic selection AF, the registered AF point will blink.



- When the AF point is registered, the following will be displayed:
 - Automatic selection AF: [] **HP** (HP: Home Position)
 - Single-point Spot AF (manual selection), Single-point AF (manual selection), AF point expansion (manual selection ⦿), AF point expansion (manual selection, surrounding points): **SEL []** (Center), **SEL HP** (Off center)
- To cancel the registered AF point, hold down the <INFO.> button, then press the <INFO.> button. The registered AF point will also be canceled if you select [**4: Clear all camera settings**].

- **AI Servo AF characteristics** (p.113)
Press the <AF-ON> or <✳> button to perform AF with the set case from [Case 1] to [Case 6].
- **AF operation** (p.88)
Press the <AF-ON> or <✳> button to perform AF with the set AF operation.
- **AF area selection mode** (p.91)
Press the <AF-ON> or <✳> button to perform AF with the set AF area selection mode.

If you want to keep using the currently selected AF point when you press the <AF-ON> or <✳> button, set [AF start position] to [Manually selected AF point]. If you want to keep the currently set AI Servo AF characteristics, AF operation, and AF area selection mode, select [Maintain current setting].



- If [AF4: Orientation linked AF point] is set to [Separate AF pts: Area+pt] or [Separate AF pts: Pt only], you can separately register the AF points to be used for vertical (grip up or down) and horizontal shooting.
- If [Registered AF point] and [AF area selection mode] are both set for [AF start position], [Registered AF point] will take effect.

AF-OFF: AF stop

The AF will stop while you hold down the button assigned to this function. Useful when you want to stop the AF during AI Servo AF.

AF-- : Switch to registered AF function

After setting and assigning this function to a button, you can apply the following settings by holding down the assigned button for AF: AF area selection mode (p.91), Tracking sensitivity (p.118), Acceleration/ deceleration tracking (p.119), AF point auto switching (p.120), Servo 1st image priority (p.122), and Servo 2nd image priority (p.123). Useful when you want to change the AF characteristics during AI Servo AF.

*2: With the setting screen displayed, press the <INFO.> button to display the detailed settings screen. Turn the <◁> or <▷> dial to select the parameter to be registered, then press <SET> to add a checkmark [✓]. When you select a parameter, then press <SET>, you can adjust the parameter setting. By pressing the <↶> button, you can revert the settings to their defaults.

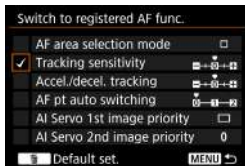

ONE SHOT / AI SERVO : ONE SHOT ↔ AI SERVO

You can switch the AF operation. In One-Shot AF mode, when you press the button to which this function is assigned, the camera switches to AI Servo AF mode. If you press the button in the AI Servo AF mode, the camera switches to One-Shot AF mode. Useful when you need to keep switching between One-Shot AF and AI Servo AF for a subject that keeps moving and stopping.



*3: With the setting screen displayed, when you press the <INFO.> button, you can select [Switch only when btn is held] or [Switch each time btn is pressed].

□ □ HP : Switch to registered AF point

During metering, when you press the button assigned to this function, focusing point can be switched to the registered AF point.

*4: With the setting screen displayed, when you press the <INFO.> button, you can select [Switch only when btn is held] or [Switch each time btn is pressed]. To register the AF point, see page 448.

: Direct AF point selection





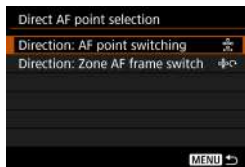

During metering, you can select an AF point directly with the  or  dial without pressing the  button.

- *5: With the Quick Control Dial setting screen displayed, you can press the <INFO.> button, then set the direction for switching the AF point for when the  dial is turned. The [**Direction: AF point switching**] settings for [**Horizontal**] and [**Vertical**] will work for Single-point Spot AF, Single-point AF, Man. select.: AF point expansion, and Expand AF area: Surround. The [**Direction: Zone AF frame switch**] settings for [**Cycle through the zones**], [**Horizontal**], and [**Vertical**] will work with Zone AF.



- *6: On the Multi-controller setting screen, press the <INFO.> button and you can select the AF point ([**Switch to center AF point**] or [**Switch to registered AF point**]) the camera will switch to when you press the center of . To register the AF point, see page 448.

: Select AF point (during metering)

During metering, you can select an AF point directly with  without pressing the  button. When this function is set, the functions of the  and  buttons will be switched between them. By holding down the  button and turning the  dial, you can set the exposure compensation or aperture.

- *7: With the setting screen displayed, you can press the <INFO.> button, then set the direction for switching the AF point for when the  dial is turned. The [**Direction: AF point switching**] settings for [**Horizontal**] and [**Vertical**] will work for Single-point Spot AF, Single-point AF, Man. select.: AF point expansion, and Expand AF area: Surround. The [**Direction: Zone AF frame switch**] settings for [**Cycle through the zones**], [**Horizontal**], and [**Vertical**] will work with Zone AF.

 : **Pause Movie Servo AF**

During Movie Servo AF, you can pause the AF when you press the button assigned to this function. Press the button again to resume Movie Servo AF.

 : **Metering start**

When you press the shutter button halfway, exposure metering is performed (AF is not performed).

 : **AE lock**

When you press the button assigned to this function, you can lock the exposure (AE lock) during metering. Useful when you want to focus and meter the shot separately.

 : **AE lock (while button pressed)**

The exposure will be locked (AE lock) while you press the shutter button.

 : **AE lock (hold)**

When you press the button assigned to this function, you can lock the exposure (AE lock). The AE lock will be maintained until you press the button again. Useful when you want to focus and meter the shot separately or when you want to take multiple shots at the same exposure setting.

 : **AE lock, AF stop**

When you press the button assigned to this function, you can lock the exposure (AE lock) and the AF will stop. Useful during AI Servo AF if you want AE lock at the same time when AF stops.



 If you assign [**AE lock (while button pressed)**] to the shutter button, any buttons assigned to [**AE lock**] or [**AE lock (hold)**] will also work as [**AE lock (while button pressed)**].



FEL: FE lock



For flash photography, pressing the button assigned to this function will fire a preflash and record the required flash output (FE lock).



ISO: Set ISO speed



You can press < > to change the ISO speed. Set while looking at the top LCD panel or viewfinder.



ISO : Set ISO speed (hold button, turn )



You can set the ISO speed by holding down < > and turning the < > dial. If this control is used with ISO Auto set, manual ISO speed setting will take effect. It is not possible to revert to the ISO Auto setting. If you use this function in the <**M**> mode, you can adjust the exposure with the ISO speed while maintaining the current shutter speed and aperture value.

ISO : Set ISO speed ( during metering)

During metering, you can set the ISO speed by turning the < > dial. The settable range is the same as with [Set ISO speed (hold btn, turn )].



ISO  Set ISO,  ↔ ISO ( during metering)

During metering, you can set the ISO speed by turning the < > dial. When this function is set, the functions of the < > and <ISO> buttons will be switched between the two. By pressing the <ISO> button and turning the < > dial, you can set the exposure compensation or aperture value.



 : Exposure compensation (hold button, turn )

You can set the exposure compensation by holding down <SET> and turning the < > dial. Useful when you want to set exposure compensation in <M> manual exposure with ISO Auto set.



T_v : Shutter speed setting in M mode



In manual exposure <M> mode, you can set the shutter speed with the < > or < > dial.

A_v : Aperture setting in M mode

In manual exposure <M> mode, you can set the aperture with the < > or < > dial.

 : Image size selection

While looking at the rear LCD panel, you can press <SET> to select the other card or set the image size. To select the other card, turn the < > dial. To set the image size, turn the < > dial.

 The operations for [Set ISO speed (hold btn, turn )] (p.453) and [Expo comp (hold btn, turn )] are possible even when the power switch is set to <LOCK> (Multi-function lock, p.66).

RAW JPEG : One-touch image quality setting

Pressing the button assigned to this function will switch to the image size set here. While the camera switches the image size, the **JPEG RAW** icon will blink in the viewfinder and the image size will blink on the rear LCD panel. After the shooting ends, the One-touch image quality setting will be canceled and the camera will switch back to the previous image size.

*8: With the setting screen displayed, by pressing the <INFO.> button, you can set the image size for this function.

RAW JPEG H : One-touch image quality (hold)

Pressing the button assigned to this function will switch to the image size set here. While the camera switches the image size, the **JPEG RAW** icon will blink in the viewfinder and the image size will blink on the rear LCD panel. Even after shooting, the One-touch image quality setting will not be canceled. To revert to the previous image size, press the button assigned to this function again.

*8: With the setting screen displayed, by pressing the <INFO.> button, you can set the image size for this function.

Record function+card/folder selection

Press <SET> to display the Record func+card/folder selection screen on the LCD monitor (p.152).

Picture Style

Press <SET> to display the Picture Style selection setting screen on the LCD monitor (p.169).

WB: White balance selection

You can press <SET> to change the white balance. Set it while looking at the top LCD panel or viewfinder.

Depth-of-field preview

Pressing the button assigned to this function will stop down the lens aperture so you can check the depth of field (p.235).

IS start

If you press the button assigned to this function when the lens's IS switch is set to <ON>, the lens's Image Stabilizer will operate.

MENU: Menu display

Press <SET> to display the menu on the LCD monitor.

Register/recall shooting function



You can manually set the main shooting functions, such as the shutter speed, aperture, ISO speed, metering mode, and AF area selection mode, and can register them to the camera. Only while you hold down the button assigned to this function, you can recall and use the registered shooting function settings to take a picture.

*9: With the setting screen displayed, press the <INFO.> button to display the detailed settings. Turn the <DISP.> or <INFO.> dial to select the function to be registered, then press <SET> to add a checkmark [✓] to it. When you select a function and press <SET>, you can adjust the setting. By pressing the <RESET> button, you can revert the settings to their defaults. By selecting [**Register current settings**], the camera's current settings will be registered. To register the AF point, see page 448.



UNLOCK  : Unlock while button pressed

Even when the power switch is set to <LOCK>, as long as the button assigned to this function is held down, you can use the camera control buttons and dials restricted by [.6: Multi function lock].

 : Start movie recording (when  set)



For movie shooting, pressing the button assigned to this function will start the movie shooting. To stop the movie shooting, press the button again.

 : Switch to Custom shooting mode

When the shooting mode is not <C1>, <C2>, or <C3>, you can press the <M-Fn> button to switch to the registered Custom shooting mode (p.472). Under [.3: Restrict shooting modes], if [C1], [C2], and [C3] have a checkmark [✓], each time you press the <M-Fn> button, the mode will be changed in the following sequence: C1 → C2 → C3 → current shooting mode.

 : Image replay

Press <SET> to play back the images.

 : Magnify/Reduce (press SET, turn )

Press <SET> to magnify or reduce the images recorded on the card (p.355). You can also magnify the image during Live View shooting and movie shooting (p.290, 291).

 : Magnify/Reduce button

Assigns the same function as the <Q> button.

 : Playback button

Assigns the same function as the <> button.

INFO : Info button

Assigns the same function as the <INFO.> button.

🗑️ : Erase button

Assigns the same function as the <🗑️> button.

🔒 : Protect button

Assigns the same function as the <🔒/> button.

🔄 : Cycle between the set functions

Pressing the <M-Fn> button each time will switch the shooting function settings in the following sequence: ISO speed, exposure compensation/aperture, white balance, drive mode/AF operation, flash exposure compensation/metering mode, AEB setting, shooting mode.

*10: With the setting screen displayed, press the <INFO.> button to display the detailed settings. You can select the functions to switch. Turn the <🕒> dial to select the desired function, then press <SET> to add a checkmark [✓]. Then select [OK] to register the setting.



🔦 : Flash function settings

Press <SET> to display the flash function setting screen.

OFF : No function (disabled)

Use this setting when you do not want to assign any function to the button.

Custom Quick Control

On the standard Quick Control screen (p.67), preset shooting functions are displayed in the default layout. On the Custom Quick Control screen, you can customize the screen with your preferred shooting functions and layout. This feature is called “Custom Quick Control”. This page explains how to change the layout of the Custom Quick Control screen. Page 68 explains how to operate the Quick Control, and page 478 explains how to display the Custom Quick Control screen.

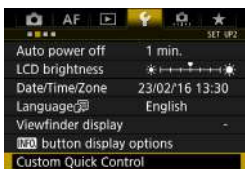

1 Select [Custom Quick Control].

- Under the [**Q**] tab, select [**Custom Quick Control**], then press <[SET]>.

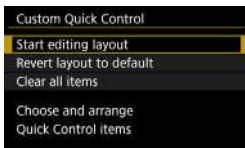

2 Select [Start editing layout].



3 Read the operation procedure and select [OK].

- **+** : Add item
- **-** : Remove
- **✓** : Select and confirm

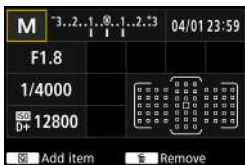

- Items displayed on the default screen are shown on the left.



4 Add an item.

- Press the $\langle \text{Q} \rangle$ button.
- Turn the $\langle \odot \rangle$ dial or use $\langle \odot \rangle$ to select the item to be added, then press $\langle \text{SET} \rangle$.
- To remove an item, select the item, then press the $\langle \text{trash} \rangle$ button. Otherwise, select **[Clear all items]** in step 2.
- For items that let you select the icon size, turn the $\langle \odot \rangle$ dial or use $\langle \odot \rangle$ to select the size, then press $\langle \text{SET} \rangle$.
- For items which can be positioned and for display sizes, see page 462.



5 Position the item.

- Use $\langle \text{directional} \rangle$, $\langle \odot \rangle$ or $\langle \odot \rangle$ to move the item (framed with directional wedges) to the desired position.
- If you want to change the size, press the $\langle \text{INFO} \rangle$ button to change it.
- Press $\langle \text{SET} \rangle$ to place the item. If there is already an item on that position, it will be overwritten (deleted).
- To change the position of an item, select the item, then press $\langle \text{SET} \rangle$ to move it.

 If you first want to delete all the items displayed by default, select **[Clear all items]** in step 2, then go to step 4.

Sample layout



- Repeat steps 4 and 5 to position other items as desired.
- To delete an item already in position, select it, then press the < > button.

6 Exit the setting.

- Press the <MENU> button to exit the setting. The screen in step 2 will reappear.

Sample screen

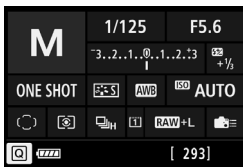

7 Check the setting screen.

- Under [2: **INFO** button display options], check that [**Custom Quick Control screen**] has a checkmark [✓] (p.478).
- Press the <INFO.> button to display the Custom Quick Control screen (p.478) and check the layout.
- Press the <Q> button to use the Quick Control (p.68).

Resetting the Custom Quick Control Screen or Clearing All Items

In step 2, selecting [**Revert layout to default**] will initialize the current setting and revert the Custom Quick Control screen to the default layout (p.459).

Selecting [**Clear all items**] will delete all the items set. The screen will then become blank except for the bottom line.

Available Items and Display Sizes for the Screen Layout

(Vertical x horizontal cells)

Item and Size	1x1	1x2	1x3	1x5	2x2	2x3	3x1	4x1
Shooting mode	<input type="radio"/>				<input type="radio"/>			
Shutter speed	<input type="radio"/>	<input type="radio"/>						
Aperture	<input type="radio"/>	<input type="radio"/>						
ISO speed	<input type="radio"/>	<input type="radio"/>						
Exposure compensation/AEB setting	<input type="radio"/>	<input type="radio"/>	<input type="radio"/>					
Flash exposure compensation	<input type="radio"/>	<input type="radio"/>	<input type="radio"/>					
Picture Style	<input type="radio"/>		<input type="radio"/>					
White balance	<input type="radio"/>	<input type="radio"/>						
White balance shift/bracketing	<input type="radio"/>	<input type="radio"/>						
Auto Lighting Optimizer	<input type="radio"/>							
Custom Controls	<input type="radio"/>							
AF operation	<input type="radio"/>	<input type="radio"/>						
AF point selection	<input type="radio"/>					<input type="radio"/>		
Metering mode	<input type="radio"/>							
Drive mode	<input type="radio"/>							
Recording function/card selection	<input type="radio"/>	<input type="radio"/>			<input type="radio"/>			
Date/Time/Zone	<input type="radio"/>	<input type="radio"/>		<input type="radio"/>		<input type="radio"/>		
External Speedlite control	<input type="radio"/>							
Highlight tone priority	<input type="radio"/>							
Viewfinder grid	<input type="radio"/>							
Sensor cleaning	<input type="radio"/>							
Exposure level							<input type="radio"/>	<input type="radio"/>
GPS setting	<input type="radio"/>							

- Depending on the items, the amount of displayable information and settable functions for Quick Control may vary due to their display sizes.
- The same item cannot be placed in multiple positions on the screen.

MENU Registering My Menu

Under My Menu tab, you can register menu items and Custom Functions whose settings you change frequently. You can also name the registered menu tabs and press the <MENU> button to display the My Menu tab first.

Creating and Adding My Menu Tab

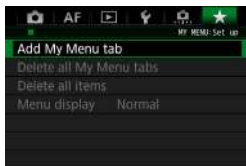

1 Select [Add My Menu tab].

- Under the [★] tab, select [Add My Menu tab], then press <SET>.

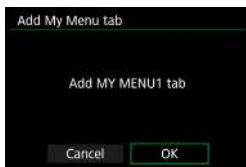

2 Select [OK].

- ▶ The [MY MENU1] tab is created.
- You can create up to five menu tabs by repeating steps 1 and 2.

Registering Menu Items under the My Menu Tab(s)



1 Select [Configure: MY MENU*].

- Turn the <DIAL> to select [Configure: MY MENU*] (tab for registering menu items), then press <SET>.

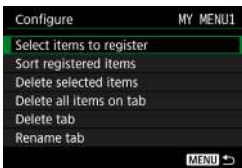

2 Select [Select items to register].

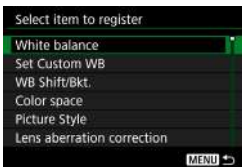

3 Register the desired items.

- Select the desired item, then press <SET>.
- Select [OK] on the confirmation dialog.
- You can register up to six items.
- To return to the screen in step 2, press the <MENU> button.

My Menu Tab Settings

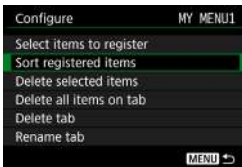

You can sort and delete items under the menu tab, and rename or delete the menu tab.

• Sort registered items

You can change the order of the registered items in My Menu. Select [Sort registered items] and select the item whose order you want to change. Then press <SET>. With [◆] displayed, turn the <◉> dial to change the order, then press <SET>.

• Delete selected items / Delete all items on tab

You can delete any of the registered items. [Delete selected items] deletes one item at a time, and [Delete all items on tab] deletes all the registered items under the tab.

● Delete tab

You can delete the My Menu tab currently displayed. Select [**Delete tab**] to delete the [**MY MENU***] tab.

● Rename tab

You can rename the My Menu tab from [**MY MENU***].

1 Select [**Rename tab**].

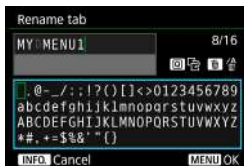

2 Enter text.

- Press the <☒> button to delete any unnecessary characters.
- Operate the <☺>, <☷>, or <☼> to move the and select the desired character. Then press <SET> to enter it.
- You can enter up to 16 characters.
- To cancel the text entry, press the <INFO.> button, then select [**OK**].

3 Exit the setting.

- After entering the text, press the <MENU> button, then select [**OK**].
- ▶ The set name is saved.



If you cannot enter text in step 2, press the <☐> button and use the character palette when the blue frame appears.

Deleting all My Menu tabs / Deleting all items

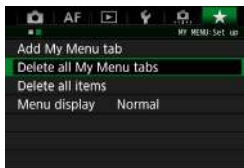

You can delete all My Menu tabs or all My Menu items you created.

- **Delete all My Menu tabs**

You can delete all My Menu tabs you created. When you select [**Delete all My Menu tabs**], all the tabs from [**MY MENU1**] to [**MY MENU5**] will be deleted and the [**★**] tab will revert to its default.

- **Delete all items**

You can delete only but all the items registered under the [**MY MENU1**] to [**MY MENU5**] tabs. The tab(s) will remain. When [**Delete all items**] is selected, all the items registered under all the created tabs will be deleted.

ⓘ If you perform [**Delete tab**] or [**Delete all My Menu tabs**], tab names renamed with [**Rename tab**] will also be deleted.

Menu Display Settings

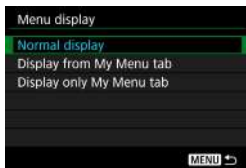

You can select [**Menu display**] to set the menu screen that is to appear first when you press the <MENU> button.

- **Normal display**
Displays the last displayed menu screen.
- **Display from My Menu tab**
Displays with the [★] tab selected.
- **Display only My Menu tab**
Only the [★] tab is displayed. (The 📷, AF, ▶, 📺, and 📶 tabs will not be displayed.)

MENU Saving and Loading Camera Settings

The camera's shooting functions, menu functions, Custom Functions, and other camera settings can be saved to the card as a camera settings file. When this file is loaded to the camera, the saved camera settings will be applied. You can save your preferred settings for a particular scene or subject and load the settings file to another EOS-1D X Mark II.

Saving Camera Settings



1 Select [Save/load cam settings on card].

- Under the [**4**] tab, select [Save/load cam settings on card], then press <SET>.

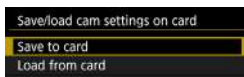

2 Select [Save to card].

Target card

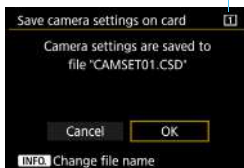

3 Select [OK].

- The camera settings will be saved to the card.



- On the screen in step 3, you can press the <INFO> button to change the file name (8 characters) as desired and save it.
- For the procedure, see “Changing the File Name” on page 203. The number of characters that can be entered will be different, but the procedure for entering the file name is the same.



Camera settings files saved by a camera other than a EOS-1D X Mark II cannot be loaded to this camera.



Up to ten camera settings files can be saved on a card. If the card already has ten camera settings files, you can either overwrite an existing file or use another card.

Saved Settings

● Shooting functions

Shooting mode, Shutter speed, Aperture, ISO speed, AF operation, AF area selection mode, AF point, Drive mode, Metering mode, Exposure compensation amount, AEB increment, Flash exposure compensation amount

● Menu display

[📷1] White balance, WB correction/BKT setting (stills)/WB correction (movies), Color space, Picture Style, Lens aberration correction, Multiple exposure (setting)

[📷2] JPEG quality, Image size, ISO speed settings, Auto Lighting Optimizer, Long exposure noise reduction, High ISO speed noise reduction, Highlight tone priority

[📷3] Image review time, Beep, Release shutter without card, Mirror lockup, Flash firing, E-TTL II flash metering, Flash sync speed in Av mode, Anti-flicker shooting

[📷4 (Live View shooting)]

Live View shooting, AF method, Grid display, Exposure simulation

[📷5 (Live View shooting)]

LV silent shooting, Metering timer, LV touch control

[CAMERA 4 (Movie)]

Movie Servo AF, AF method, Grid display, Movie recording quality, Sound recording, AF speed with Movie Servo AF, Movie Servo AF subject tracking

[CAMERA 5 (Movie)]

Metering timer, LV touch control, Silent control,  button function, HDMI connection display

[AF1] Case 1, Case 2, Case 3, Case 4, Case 5, Case 6

[AF2] AI Servo 1st image priority, AI Servo 2nd image priority

[AF3] Lens electronic MF, AF-assist beam firing, One-Shot AF release priority

[AF4] Auto AF point selection: EOS iTR AF, Lens drive when AF impossible, Selectable AF point, Select AF area selection mode, AF area selection method, Orientation linked AF point, Initial AF point with  AI Servo AF

[AF5] AF point selection pattern, AF point display during focus, Viewfinder display illumination, AF status in viewfinder, AF Microadjustment

[▶2] Image jump with 

[▶3] Highlight alert, AF point display, Playback grid, Histogram display, Magnification (approx.)

[🔊1] Recording function, File numbering, File name, Auto rotate

[🔊2] Auto power off, LCD brightness, Viewfinder display, **INFO** button display options

[🔊3] Auto cleaning, GPS settings (GPS, Auto time setting, Position update interval, Log GPS position), HDMI output frame rate

- [1] Exposure level increments, ISO speed setting increments, Bracketing auto cancel, Bracketing sequence, Number of bracketed shots, AF point-linked spot metering
- [2] Safety shift, Same exposure for new aperture
- [3] Restrict shooting modes, Restrict metering modes, Metering used in manual exposure, Set shutter speed range, Set aperture range, AE Microadjustment, FE Microadjustment
- [4] Continuous shooting speed, Limit continuous shot count, Restrict drive modes
- [5] Focusing screen, Viewfinder info. during exposure, LCD panel illumination during Bulb, Recording card and image size setting
- [6] Warnings in viewfinder, Dial direction during Tv/Av, Av setting without lens, Multi function lock, Custom Controls, / button function
- [7] Add cropping information, Timer duration, Shutter release time lag, Memo audio quality, Default Erase option, Retract lens on power off



Menu items under the [★] My Menu tab will also be preserved.

Loading Camera Settings

In step 2, select [**Load from card**]. Up to ten camera settings files saved in the card will be displayed. When you select the desired file, it will be loaded, and the settings will be applied to the camera.

C: Registering Custom Shooting Modes

You can register current camera settings, such as the shooting functions, menu functions, and Custom Function settings, as Custom shooting modes under the Mode Dial's <C1>, <C2>, and <C3> positions. To use <C2> or <C3>, use [..3: Restrict shooting modes] to enable <C2> and <C3> (p.427).



1 Select [Custom shooting mode (C1-C3)].

- Under the [4] tab, select [**Custom shooting mode (C1-C3)**], then press <SET>.

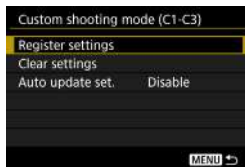

2 Select [Register settings].

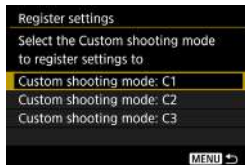

3 Register the desired items.

- Select the Custom shooting mode to be registered, then press <SET>.
- Select [**OK**] on the confirmation dialog.
- The current camera settings (p.473) will be registered under the Mode Dial's C* position.

Automatic Update of Registered Settings

If you change a setting while shooting in the <C1>, <C2>, or <C3> mode, the respective Custom shooting mode can be updated automatically to reflect the change in the setting (Auto update). To enable this automatic update, set [**Auto update set.**] to [**Enable**] in step 2.

Canceling Registered Custom Shooting Modes

If you select [**Clear settings**] in step 2, the settings of respective modes can be reverted to the default settings with no Custom shooting modes registered.



My Menu settings will not be registered under Custom shooting modes.



Even in the <C1>, <C2>, or <C3> shooting mode, you can still change the shooting function settings and menu function settings.

Settings To Be Registered

- **Shooting functions**

Shooting mode, Shutter speed, Aperture, ISO speed, AF operation, AF area selection mode, AF point, Drive mode, Metering mode, Exposure compensation amount, AEB increment, Flash exposure compensation amount

- **Menu display**

[1] White balance, WB correction/BKT setting (stills)/WB correction (movies), Color space, Picture Style, Lens aberration correction, Multiple exposure (setting)

[2] JPEG quality, Image size, ISO speed settings, Auto Lighting Optimizer, Long exposure noise reduction, High ISO speed noise reduction, Highlight tone priority

[3] Image review time, Beep, Release shutter without card, Mirror lockup, Flash firing, E-TTL II flash metering, Flash sync speed in Av mode, Anti-flicker shooting

[📷4 (Live View shooting)]

Live View shooting, AF method, Grid display, Exposure simulation

[📷5 (Live View shooting)]

LV silent shooting, Metering timer, LV touch control

[📷4 (Movie)]

Movie Servo AF, AF method, Grid display, Movie recording quality, Sound recording, AF speed with Movie Servo AF, Movie Servo AF subject tracking

[📷5 (Movie)]

Metering timer, LV touch control, Movie rec count, Movie play count, Silent control,  button function, HDMI connection display

[AF1] Case 1, Case 2, Case 3, Case 4, Case 5, Case 6

[AF2] AI Servo 1st image priority, AI Servo 2nd image priority













[AF3] Lens electronic MF, AF-assist beam firing, One-Shot AF release priority

[AF4] Auto AF point selection: EOS iTR AF, Lens drive when AF impossible, Selectable AF point, Select AF area selection mode, AF area selection method, Orientation linked AF point, Initial AF point with  AI Servo AF

[AF5] AF point selection pattern, AF point display during focus, Viewfinder display illumination, AF status in viewfinder, AF Microadjustment (excluding the adjustment amount)

[▶2] Image jump with 

[▶3] Highlight alert, AF point display, Playback grid, Histogram display, Movie play count, Magnification (approx.)

- [1] File numbering, Auto rotate
- [2] Auto power off, LCD brightness, Viewfinder display, **INFO.** button display options
- [3] Auto cleaning, HDMI output frame rate
- [1] Exposure level increments, ISO speed setting increments, Bracketing auto cancel, Bracketing sequence, Number of bracketed shots, AF point-linked spot metering
- [2] Safety shift, Same exposure for new aperture
- [3] Restrict shooting modes, Metering used in manual exposure, Set shutter speed range, Set aperture range, AE Microadjustment (excluding the adjustment amount), FE Microadjustment (excluding the adjustment amount)
- [4] Continuous shooting speed, Limit continuous shot count, Restrict drive modes
- [5] Viewfinder info. during exposure, LCD panel illumination during Bulb, Recording card and image size setting
- [6] Dial direction during Tv/Av, Av setting without lens, Multi function lock, Custom Controls (excluding <M-Fn> button setting), / button function
- [7] Add cropping information, Timer duration, Shutter release time lag, Memo audio quality, Default Erase option, Retract lens on power off



14

Reference

This chapter provides reference information for camera features, system accessories, etc.



Certification Logo

Select [**F4: Certification Logo Display**] and press <SET> to display some of the logos of the camera's certifications. Other certification logos can be found in this Instruction Manual, on the camera body, and on the camera's package.

INFO. Button Functions



When you press the <INFO.> button with the camera being ready to shoot, you can switch the display as follows:
Displays camera settings (p.479),
Electronic level (p.82),
Quick Control screen (p.480), and
Custom Quick Control screen (p.461).

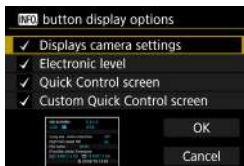

[**INFO.** button display options] under [**2**] tab enables you to select the options displayed when the <INFO.> button is pressed.

- Select the desired display option and press <SET> to add a checkmark [✓].
- Then select [OK] to register the setting.

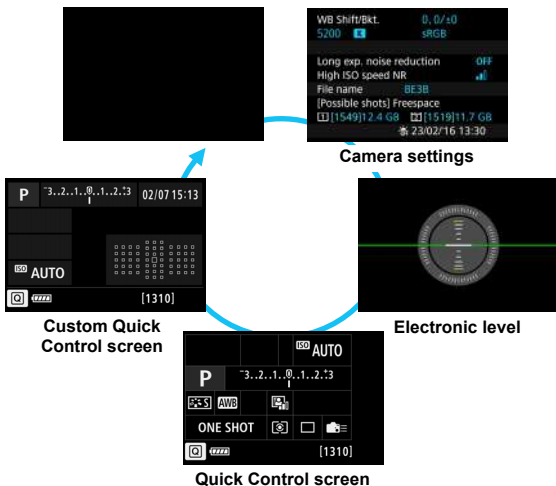



- If you turn off the power with the Electronic level, Quick Control screen, or Custom Quick Control screen displayed, the same screen will be displayed when you turn on the power again. To cancel this function, press the <INFO.> button a number of times until the screen is blank, then turn off the power switch.
- Note that you cannot remove the [✓] for all four display options.
- The [Displays camera settings] sample screen is displayed in English for all languages.
- Even if you set not to display the [Electronic level], it will still appear for Live View shooting and movie shooting when you press the <INFO.> button.
- While the Quick Control screen or Custom Quick Control screen is displayed, pressing the <Q> button enables you to set a function with Quick Control (p.68).

Camera Settings

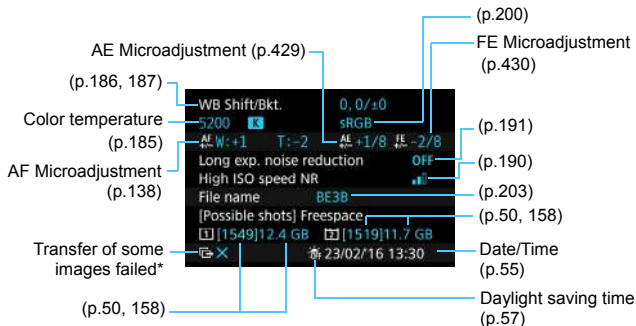

* This icon is displayed when the transfer of some images failed.

Quick Control Screen

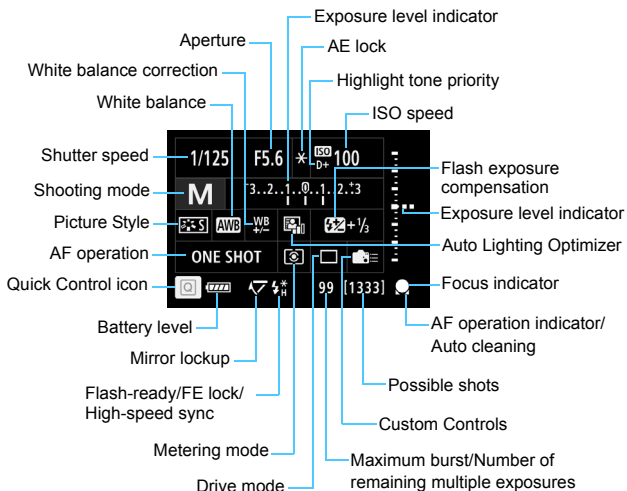

* The display will show only the settings currently applied.

Custom Quick Control screen

For the Custom Quick Control, see page 459.

Button Operation for the Quick Control and Custom Quick Control Screens

When you press the <MODE>, <DRIVE•AF>, <AF-ON>, <INFO>, <ISO>, <WB>, or <WB> button, the setting screen will appear and you can use <MENU>, <OK>, <DISP>, and <M-Fn> to set the function.



Shooting mode

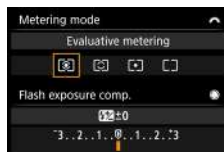
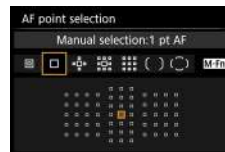

AF operation / Drive mode

Metering mode/
Flash exposure compensation

AF point selection



ISO speed



Exposure compensation

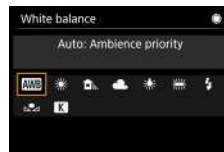

White balance

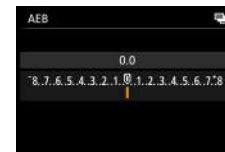

AEB

MENU Checking the Battery Information

You can check the conditions of the battery you are using on the LCD monitor.

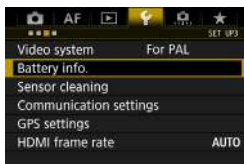

Select [Battery info.].

- Under the [F3] tab, select [Battery info.], then press <SET>.

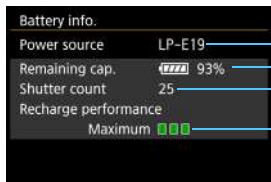

The model of the battery or household power source accessory (sold separately) being used is displayed.

The battery level indicator (p.54) is displayed together with the remaining battery level in 1% increments.

The number of shots taken with the current battery. The number is reset when the battery is recharged (p.42).

Battery's recharge performance level is displayed in three levels.

■■■■ (Green): Battery's recharge performance is fine.

■■■■ (Green): Battery's recharge performance is slightly degraded.

■■■■ (Red): Purchasing a new battery is recommended.

Using genuine Canon Battery Pack LP-E19 or LP-E4N/LP-E4 is recommended. If you use batteries that are not genuine Canon products, the camera's full performance may not be attained or malfunction may result.



- The shutter count is the number of still photos taken. (Movie shooting is not counted.)
- If [Calibration is recommended when charging battery next time] is displayed, see page 45.
- If a battery communication error message is displayed, follow the message.

Using a Household Power Outlet

You can power the camera with a household power outlet by using the DC Coupler DR-E19 and AC Adapter AC-E19 (both sold separately).

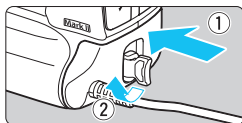

1 Insert the DC coupler.

- Insert the DC coupler firmly all the way into the camera, and turn the release handle as shown by the arrow.

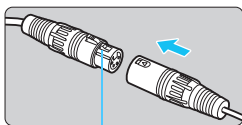

2 Connect the DC coupler to the AC adapter.

- Securely connect the DC coupler's connector to the AC adapter's connector.

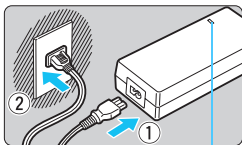

3 Connect the power cord.

- ▶ The AC adapter's power lamp will light.
- Connect the power cord to the AC adapter and insert the power plug into a power outlet.

4 Set the camera's power switch to <ON> (p.53).



- Do not use an AC adapter other than the AC-E19 (sold separately).
- Since the DC coupler and AC adapter are not water-resistant, do not get them wet.
- While the camera's power switch is on, do not connect or disconnect the power cord or connector or disconnect the DC coupler.
- If the camera's power switch is on and you do steps 2 and 3, it may take a while before the camera turns on.
- After using the camera, unplug the power plug from the power outlet.



- To disconnect the connector, hold down the disconnect button and pull the connector.
- You can also use AC Adapter Kit ACK-E4.

System Map

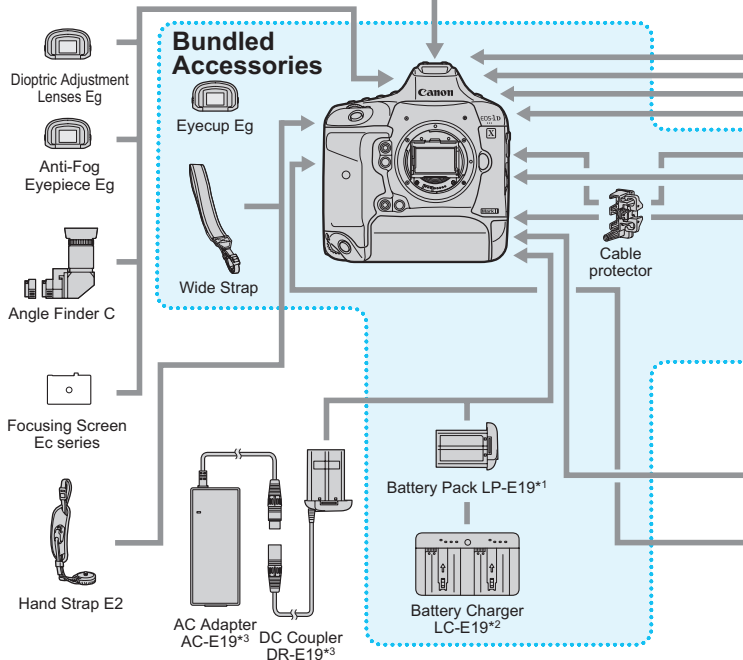
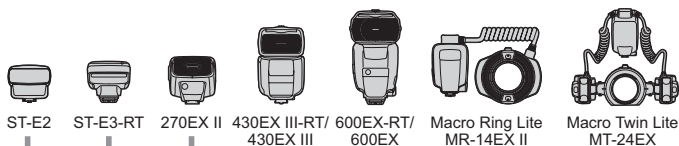

*1: Cannot be charged with a battery charger other than Battery Charger LC-E19.

Battery Pack LP-E4N/E4 can also be used to provide power.

*2: Battery Pack LP-E4N/LP-E4 can also be charged.

*3: AC Adapter Kit ACK-E4 can also be used.

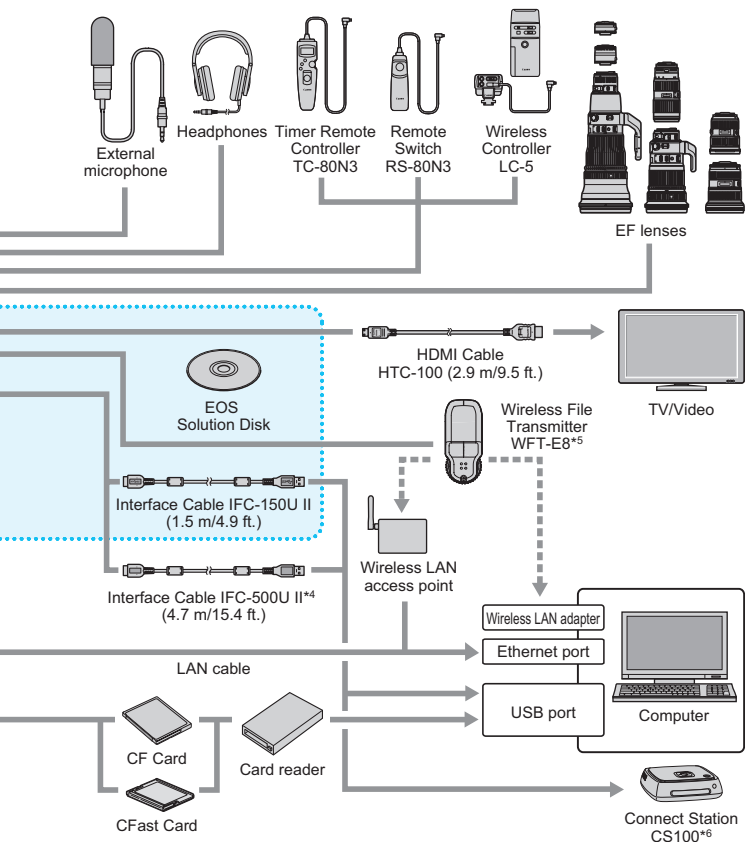

*4: With IFC-500U II, the communication speed will be equivalent to Hi-Speed USB (USB 2.0).

*5: Wireless File Transmitter WFT-E6 can also be used. To use the WFT-E6, download the latest WFT-E6 Instruction Manual (PDF file) from Canon website.

*6: Use the latest version of the Connect Station firmware.

* All cable lengths given are approximate figures.

Function Availability Table by Shooting Mode

Still Photo Shooting

● : Set automatically ○ : User selectable □ : Not selectable/Disabled

Function		P	Tv	Av	M	bulb
All image quality settings selectable		○	○	○	○	○
ISO speed	Automatically set/Auto	○	○	○	○	○
	Manually set	○	○	○	○	○
Picture Style	Automatically set/Auto	○	○	○	○	○
	Manual selection	○	○	○	○	○
White balance	Auto	○	○	○	○	○
	Preset	○	○	○	○	○
	Custom	○	○	○	○	○
	Color temperature setting	○	○	○	○	○
	Correction/Bracketing	○	○	○	○	○
Auto Lighting Optimizer		○	○	○	○	○
Long exposure noise reduction		○	○	○	○	○
High ISO speed noise reduction		○	○	○	○	○
Highlight tone priority		○	○	○	○	○
Lens aberration correction	Peripheral illumination correction	○	○	○	○	○
	Chromatic aberration correction	○	○	○	○	○
	Distortion correction	○	○	○	○	○
	Diffraction correction	○	○	○	○	○
Anti-flicker shooting*1		○	○	○	○	○
Color space	sRGB	○	○	○	○	○
	Adobe RGB	○	○	○	○	○
AF	One-Shot AF*1	○	○	○	○	○
	AI Servo AF*1	○	○	○	○	○
	AF area selection mode*1	○	○	○	○	○
	AF point	○	○	○	○	○
	Manual focusing (MF)	○	○	○	○	○
	AF Configuration Tool	○	○	○	○	○
	AF Microadjustment*1	○	○	○	○	○
	⌂+Tracking*2	○	○	○	○	○
FlexiZone - Single*2	○	○	○	○	○	

Function		P	Tv	Av	M	bulb
Drive	Single shooting	○	○	○	○	○
	High-speed continuous shooting	○	○	○	○	○
	Low-speed continuous shooting	○	○	○	○	○
	Single: Silent shooting	○	○	○	○	○
	Silent high-speed shooting	○	○	○	○	○
	Silent low-speed shooting	○	○	○	○	○
	Self-timer: 10 sec.	○	○	○	○	○
	Self-timer: 2 sec.	○	○	○	○	○
Metering	Evaluative metering	○	○	○	○	○
	Partial metering	○	○	○	○	○
	Spot metering	○	○	○	○	○
	Center-weighted average metering	○	○	○	○	○
Exposure	Program shift	○				
	Exposure compensation	○	○	○	○*3	
	AEB	○	○	○	○	
	AE lock	○	○	○	*4	
	Depth-of-field preview	○	○	○	○	○
	Multiple exposures	○	○	○	○	○
	Mirror lockup*1	○	○	○	○	○
External Speedlite	Flash exposure compensation	○	○	○	○	○
	FE lock*1	○	○	○	○	○
	Flash function settings	○	○	○	○	○
	Custom Function settings	○	○	○	○	○
GPS function	○	○	○	○	○	
Live View shooting	○	○	○	○	○	
Quick Control	○	○	○	○	○	
Touch control*5	○	○	○	○	○	

*1: Settable only with viewfinder shooting.

*2: Settable only with Live View shooting.





*3: Settable only with ISO Auto set.





*4: With ISO Auto, you can set a fixed ISO speed.

*5: Touch control is possible during Live View shooting.

Movie Shooting

● : Set automatically ○ : User selectable □ : Not selectable/Disabled

Function		P/bulb	Tv	Av	M
					
Select all movie recording qualities		○	○	○	○
ISO speed	Automatically set/Auto	●	●	●	○
	Manually set	□	□	□	○
Picture Style	Automatically set/Auto	○	○	○	○
	Manual selection	○	○	○	○
White balance	Auto	○	○	○	○
	Preset	○	○	○	○
	Custom	○	○	○	○
	Color temperature setting	○	○	○	○
	Correction	○	○	○	○
	Bracketing	□	□	□	□
Auto Lighting Optimizer		○	○	○	○
High ISO speed noise reduction*1		○	○	○	○
Highlight tone priority		○	○	○	○
Lens aberration correction	Peripheral illumination correction	○	○	○	○
	Chromatic aberration correction	○	○	○	○
	Distortion correction	□	□	□	□
	Diffraction correction	□	□	□	□
AF	 +Tracking	○	○	○	○
	FlexiZone - Single	○	○	○	○
	Manual focusing (MF)	○	○	○	○
	Movie Servo AF	○	○	○	○

Function		P/bulb	Tv	Av	M
					
Metering		●	●	●	●
Exposure	Program shift				
	Exposure compensation	○	○	○	○*2
	AE lock	○	○	○	*3
Sound recording	Auto	○	○	○	○
	Manual	○	○	○	○
	Line input	○	○	○	○
Time code		○	○	○	○
HDMI output		○	○	○	○
GPS function		○	○	○	○
Quick Control		○	○	○	○
Touch control		○	○	○	○

*1: Settable only for Full HD movie shooting (not settable for 4K movie shooting).

*2: Settable only with ISO Auto set.

*3: With ISO Auto, you can set a fixed ISO speed.

Menu Settings

Viewfinder Shooting and Live View Shooting

📷: Shooting 1 (Red)

Page

White balance	AWB (Ambience priority) / AWB w (White priority) / 🌞 / 🏠 / ☁️ / 🌧️ / 🌩️ / ⚡️ / 🌋 (1-5) / 📷 (Approx. 2500 - 10000)/PC-1-5	177 179
Set Custom WB	Select image on card / Record and register WB / Edit WB name / Set as white balance	180
White balance shift/bracketing*1	White balance correction: B/A/M/G bias, 9 levels each	186
	White balance bracketing: B/A and M/G bias, single-level increments, ±3 levels	187
Color space*2	sRGB / Adobe RGB	200
Picture Style	📷A Auto / 📷S Standard / 📷P Portrait / 📷L Landscape / 📷FD Fine Detail / 📷N Neutral / 📷F Faithful / 📷M Monochrome / 📷1 User Def. 1-3	169
Lens aberration correction*3	Peripheral illumination: Enable / Disable	194
	Chromatic aberration: Enable / Disable	
	Distortion correction: Disable / Enable	
	Diffraction correction: Enable / Disable	
Multiple exposure*4	Multiple exposure / Multiple exposure control / Number of exposures / Save source images / Continuous multiple exposure	248

*1: During movie shooting, [**WB Shift/Bkt.**] will be set to [**WB correction**].

*2: During movie shooting, [**Color space**] will not be displayed.

*3: During movie shooting, [**Distortion correction**] and [**Diffraction correction**] will not be displayed.

*4: During movie shooting, [**Multiple exposure**] will not be displayed.

📷 Displayed contents under [**📷2: Image type/size**] vary according to the [**Record func.**] setting of [**📷1: Record func+card/folder sel.**] (p.152). If [**Rec. separately**] is set, set the image size for each card.

 **Shooting 2 (Red)**

Page

JPEG quality	Compression rate for L , M1 , M2 , S	162
Img type/size	RAW / M RAW / S RAW	155
	L / M1 / M2 / S	
ISO speed settings*1	ISO speed / Range for stills / Auto range / Minimum shutter speed	163
		166
		167
		168
Auto Lighting Optimizer	Disable / Low / Standard / High	189
	Disabled in M or B modes	
Long Exposure Noise Reduction*2	Disable / Auto / Enable	191
High ISO speed noise reduction*3	Disable / Low / Standard / High	190
Highlight tone priority	Disable / Enable	193

*1: During movie shooting, **[ISO speed settings]** will be **[ISO speed]**, **[Range for movies]**, and **[Range for 4K]**.

*2: During movie shooting, **[Long exposure noise reduction]** will not be displayed.

*3: Cannot be set during 4K movie shooting.

 **Shooting 3 (Red)**

Image review time	Off / 2 sec. / 4 sec. / 8 sec. / Hold	77
Beeper	Enable / Disable	76
Release shutter without card	Enable / Disable	50
Mirror lockup*	Disable / Enable / Enable: Mirror down w/ SET	256
Dust Delete Data	Obtain data to be used with Digital Photo Professional (EOS software) to delete dust spots	403
External Speedlite control	Flash firing / E-TTL II metering / Flash sync. speed in Av mode / Flash function settings / Flash C.Fn settings / Clear settings	263
Anti-flicker shooting*	Disable / Enable	198

* During movie shooting, **[Mirror lockup]** and **[Anti-flicker shooting]** will not be displayed.

📷: Shooting 4 (Red)

Page

Live View shooting	Enable / Disable	273
AF method	☺+Tracking / FlexiZone - Single	284
Grid display	Off / 3x3 田 / 6x4 田田 / 3x3+diag 田田	280
Exposure simulation	Enable / During 📷 / Disable	281

📷: Shooting 5 (Red)

Silent LV shooting	Mode 1 / Mode 2 / Disable	281
Metering timer	4 sec. / 8 sec. / 16 sec. / 30 sec. / 1 min. / 10 min. / 30 min.	283
LV touch control	Standard / Sensitive / Disable	283

AF: AF1 (Purple)

Case 1	Versatile multi purpose setting	114
Case 2	Continue to track subjects, ignoring possible obstacles	114
Case 3	Instantly focus on subjects suddenly entering AF points	115
Case 4	For subjects that accelerate or decelerate quickly	115
Case 5	For erratic subjects moving quickly in any direction	116
Case 6	For subjects that change speed and move erratically	117

 Displayed contents under the [📷4] and [📷5] tabs during movie shooting is shown on pages 500-501.

AF: AF2 (Purple)

Page









AI Servo 1st image priority	Release priority / Equal priority / Focus priority	122
AI Servo 2nd image priority	Shooting speed priority: -2/-1 / Equal priority: 0 / Focus priority: +1/+2	123

AF: AF3 (Purple)

Lens electronic MF	Enable after One-Shot AF / Disable after One-Shot AF / Disable in AF mode	124
AF-assist beam firing	Enable / Disable / IR AF assist beam only	125
One-Shot AF release priority	Release priority / Focus priority	126

AF: AF4 (Purple)

Page

Auto AF point selection: EOS iTR AF	EOS iTR AF (Face priority) / EOS iTR AF / Disable	127
Lens drive when AF impossible	Continue focus search / Stop focus search	129
Selectable AF point	All points / Only cross-type AF points / 15 points / 9 points	130
Select AF area selection mode	Manual selection: Spot AF / Manual selection: 1 point AF / Expand AF area:  / Expand AF area: Surround / Manual selection: Zone AF / Manual select.: Large Zone AF / Auto selection AF	131
AF area selection method	 → M-Fn button /  → Main Dial	132
Orientation linked AF point	Same for both vertical/horizontal / Separate AF points: Area+point / Separate AF points: Point only	132
Initial AF point  AI Servo AF	Initial  AF point selected / Manual     AF point / Auto	134

AF: AF5 (Purple)

AF point selection pattern	Stops at AF area edges / Continuous	135
AF point display during focus	Selected / All / Selected (focused, ) / Selected (focused) / Disable display	135
AF point brightness	Normal / Brighter	136
AF operation display in viewfinder	Show in field of view / Show outside view	137
AF Microadjustment	Disable / All by same amount / Adjust by lens	138

▶: Playback 1 (Blue)



Page

Protect images	Protect images	359
Rotate image	Rotate images	357
Erase images	Erase images	387
Print order	Specify images to be printed (DPOF)	413
Image copy	Copy images between cards	382

▶: Playback 2 (Blue)

RAW image processing	Process RAW images	392
Cropping	Partially crop JPEG images	399
Resizing	Downsize JPEG image's pixel count	397
Rating	[OFF] / [.] / [.] / [.] / [.] / [.]	361
Slide show	Set playback description / Display time / Repeat	376
Image transfer	Image selection/transfer / RAW+JPEG transfer / Transfer with caption	410
Image jump w/ 	1 image / 10 images / 100 images / Date / Folder / Movies / Stills / Protect / Rating	353

▶: Playback 3 (Blue)

Highlight alert	Disable / Enable	350
AF point display	Disable / Enable	351
Playback grid	Off / 3x3  / 6x4  / 3x3+diag 	345
Histogram display	Brightness / RGB	351
Movie playback count*	Recording time / Time code	327
Magnification (Approx.)	1x (no magnification) / 2x (magnify from center) / 4x (magnify from center) / 8x (magnify from center) / 10x (magnify from center) / Actual size (from selected point) / Same as last magnification (from center)	356
Control over HDMI	Disable / Enable	380

* The setting is linked to the [Movie play count] for [Time code] under the [05 (Movie)] tab.

☛: Set-up 1 (Yellow)

Page



Record function+card/ folder selection	Recording function: Standard / Auto switch card / Record separately / Record to multiple	152
	Record/playback / Playback: /	154
	Folder: Selecting and creating a folder	201
File numbering	Continuous / Auto reset / Manual reset	206
File name	Preset code / User setting 1 / User setting 2	203
Auto rotate	On / On / Off	390
Format card	Erase data on the card by formatting	74

☛: Set-up 2 (Yellow)

Auto power off	1 min. / 2 min. / 4 min. / 8 min. / 15 min. / 30 min. / Disable	76
LCD brightness	Adjustable to one of seven brightness levels	389
Date/Time/Zone	Date (year, month, day) / Time (hr., min., sec.) / Daylight saving time / Time zone	55
Language	Select the interface language	58
Viewfinder Information	Electronic level: Hide / Show	83
	Grid display: Hide / Show	81
	Show/hide in viewfinder: Shooting mode / Metering mode / White balance / Drive mode / AF operation / Flicker detection	84
 button display options	Displays camera settings / Electronic level / Quick Control screen / Custom Quick Control screen	478
Custom Quick Control	Start editing layout / Revert layout to default / Clear all items	459

⚙: Set-up 3 (Yellow)

Page

Video system*1	For NTSC / For PAL	312 379
Battery information	Power source / Remaining capacity / Shutter count / Recharge performance	482
Sensor cleaning	Auto cleaning  : Enable / Disable	402
	Clean now 	
	Clean manually	405
Communication settings	Wired LAN function and WFT-E8 (sold separately)/ WFT-E6 (sold separately) wireless LAN settings	–
GPS setting	GPS / Auto time setting / Position update interval / GPS information display / GPS Logger	211
HDMI output frame rate*1*2	Auto / 59.94i/50.00i / 59.94p/50.00p / 23.98p	340

*1: Not settable if [24.00p] for [Movie rec quality] is set to [Enable].

*2: Displayed contents vary depending on the [Video system] setting.



- When using the GPS function or Wireless File Transmitter WFT-E8/ WFT-E6 (sold separately), be sure to check the countries and areas of use, and observe the laws and regulations of the country or region.
- To use the WFT-E6, download the latest WFT-E6 Instruction Manual (PDF file) from Canon website.



For details on the wired LAN function, see the “Wired LAN Instruction Manual” (p.4).

🔑: Set-up 4 (Yellow)

Page

Save/load camera settings on card	Save to card / load from card	468
Custom shooting mode (C1-C3)	Register setting / Clear settings / Auto update set.	472
Clear all camera settings	Resets the camera to the default settings	77
Copyright information	Display copyright information / Enter author's name / Enter copyright details / Delete copyright information	208
Camera system information	Serial number / Firmware version / Release cycles / Camera status log	520
Certification Logo Display	Some of the camera's certification logos are displayed	477
📷 firmware ver.	Select to update the firmware of the camera, lens, Speedlite, or Wireless File Transmitter	-

🔑: Custom Functions (Orange)

C.Fn1: Exposure	Customize camera functions as desired	421
C.Fn2: Exposure		424
C.Fn3: Exposure		427
C.Fn4: Drive		431
C.Fn5: Display/ Operation		433
C.Fn6: Operation		436
C.Fn7: Others		439
C.Fn8: Clear		Clear all Custom Function settings

★ : My Menu (Green)

Page

Add My Menu tab	Add My Menu tabs 1-5	463
Delete all My Menu tabs	Delete all My Menu tabs	466
Delete all items	Delete all items under My Menu tabs 1-5	466
Menu display	Normal display / Display from My Menu tab / Display only My Menu tab	467

Movie Shooting

📷: Shooting 2 (Movie) (Red)

Page

ISO speed settings	ISO speed / Range for movies / Range for 4K	330
---------------------------	---	-----













📷: Shooting 4 (Movie) (Red)

Movie Servo AF	Enable / Disable	331
AF method	[L] +Tracking / FlexiZone - Single	333
Grid display	Off / 3x3 [田] / 6x4 [田田] / 3x3+diag [田田]	333
Movie recording quality	MOV / MP4	311
	Movie recording size • 4K (4096x2160) / Full HD (1920x1080) • NTSC: 59.94p / 29.97p / 23.98p PAL: 50.00p / 25.00p • MJPG / ALL-I (For editing) / IPB (Standard) / IPB (Light)	312
	24.00p: Disable / Enable	317
	High Frame Rate: Disable / Enable	318
	Sound recording: Auto / Manual / Line input / Disable	322
Recording level		
Sound recording	Wind filter: Disable / Enable	323
	Attenuator: Disable / Enable	
Movie Servo AF Speed*	When active: Always on / During shooting	334
	AF speed: Slow (-7/-6/-5/-4/-3/-2/-1)/Standard/Fast (+1/+2)	
Movie Servo AF tracking sensitivity*	Locked on (-3/-2/-1)/0/Responsive (+1/+2/+3)	335



* Not settable if [AF method] is set to [L] +Tracking].

 Shooting 5 (Movie) (Red)

Page

Metering timer	4 sec. / 8 sec. / 16 sec. / 30 sec. / 1 min. / 10 min. / 30 min.	336
LV touch control	Standard / Sensitive / Disable	336
Time code	Count up / Start time setting / Movie recording count / Movie play count* ¹ / HDMI / Drop frame* ²	326
Silent control	Enable  / Disable 	325
 button function	 / - /  / - /  /  /  / 	337
HDMI display	 /  without information /  + 	338

*1: Setting is linked to the [Movie play count] under [▶3] tab.

*2: Displayed when  (119.9fps),  (59.94fps), or  (29.97fps) is set.

Troubleshooting Guide

If a problem occurs with the camera, first consult this Troubleshooting Guide. If this Troubleshooting Guide does not resolve the problem, contact your dealer or nearest Canon Service Center.

Power-Related Problems

The battery does not recharge.

- Provided Battery Charger LC-E19 can only charge the provided Battery Pack LP-E19 and genuine Battery Pack LP-E4N/LP-E4.
- Battery Charger LC-E4N/LC-E4 cannot charge the provided Battery Pack LP-E19.

The charger's <CAL> lamp blinks.

- This is a recommendation that you calibrate (discharge) the battery so that the camera can accurately determine its capacity and display its battery level accurately. For details, see page 45.

Right after attaching the battery to the charger, only the <100%> lamp lights up.

- If the charging starts and only the <100%> lamp lights in green right away, it means the battery's internal temperature is outside the appropriate temperature range. The battery will start recharging automatically when the internal temperature is within 5°C - 40°C / 41°F - 104°F.

All three charge lamps of the charger blink.

- The charger cannot charge batteries other than the provided LP-E19 and LP-E4N/LP-E4. The three charge lamps and <CAL> lamp will blink in green.
- While charging a battery, if the three charge lamps blink in green consecutively or if they blink consecutively in green with the <CAL> lamp blinking in green, remove the battery from the charger. Contact your dealer or nearest Canon Service Center.
- While calibrating a battery, if the three charge lamps blink, remove the battery from the charger. Contact your dealer or nearest Canon Service Center.

The camera does not operate even when the power switch is set to <ON>.

- Make sure the battery is installed properly in the camera (p.47).
- Make sure the card slot cover is closed (p.49).
- Recharge the battery (p.42).

The access lamp still lights or blinks even when the power switch is <OFF>.

- If the power is turned off while an image is being recorded to the card, the access lamp will remain on or continue to blink for a few seconds. When the image recording is completed, the power will turn off automatically.

[Does this battery/do these batteries display the Canon logo?] is displayed.

- Do not use any battery other than the genuine Battery Pack LP-E19 or LP-E4N/LP-E4.
- Remove and install the battery again (p.47).
- If the electrical contacts are dirty, use a soft cloth to clean them.

The battery becomes exhausted quickly.

- Use a fully-charged battery (p.42).
- The battery performance may have degraded. See [**⚙3: Battery info.**] to check the battery's recharge performance level (p.482). If the battery performance is poor, replace the battery with a new one.
- The number of possible shots will decrease with any of the following operations:
 - Pressing the shutter button halfway for a prolonged period.
 - Activating the AF frequently without taking a picture.
 - Using the lens's Image Stabilizer.
 - Using GPS.
 - Using the LCD monitor frequently.
 - Continuing Live View shooting or movie shooting for a prolonged period.

The camera turns off by itself.

- Auto power off is in effect. If you do not want auto power off to take effect, set [**⚙2: Auto power off**] to [**Disable**] (p.76).
- Even if [**⚙2: Auto power off**] is set to [**Disable**], the LCD monitor will still turn off after the camera is left idle for approx. 30 min. (The camera's power does not turn off.)

Shooting-Related Problems

The lens cannot be attached.

- The camera cannot be used with EF-S or EF-M lenses (p.59).

The viewfinder is dark.

- Install a recharged battery in the camera (p.42).

No images can be shot or recorded.

- Make sure the card is properly inserted (p.49).
- If the card is full, replace the card or delete unnecessary images to make space (p.49, 386).
- If you try to focus in the One-Shot AF mode and the focus indicator <●> in the viewfinder blinks, a picture cannot be taken. Press the shutter button halfway again to refocus automatically, or focus manually (p.62, 145).

The card cannot be used.

- If a card error message is displayed, see page 52 or 523.

An error message is displayed when the card is inserted in another camera.

- CF cards with a capacity greater than 128 GB and CFast cards are formatted in exFAT. This means that if you format a card with a capacity over 128 GB with this camera and then insert it into another camera, an error may be displayed and it may not be possible to use the card.

I have to press the shutter button twice completely to take a picture.

- Set [3: Mirror lockup] to [Disable].

The image is out of focus or blurred.

- Set the lens's focus mode switch to <AF> (p.59).
- Press the shutter button gently to prevent camera shake (p.61, 62).
- If the lens has an Image Stabilizer, set the IS switch to <ON>.
- In low light, the shutter speed may become slow. Use a faster shutter speed (p.231), set a higher ISO speed (p.163), use flash (p.260), or use a tripod.
- See “Minimizing Blurred Photos” on page 229.

There are fewer AF points or the shape of the Area AF frame is different.

- Depending on the attached lens, the number of usable AF points and patterns and Area AF frame's shape vary. The lenses are categorized into 11 groups from A to K (p.102). Check which group your lens belongs to. Using a lens in groups G to K will have fewer usable AF points (p.105-108).

The AF point is blinking or two AF points are displayed.

- Regarding the AF points lighting up or blinking when you press the <[AF-ON]> button, see page 95.
- The AF point at the registered area is blinking (p.95, 448).
- The manually-selected AF point (or zone) and the registered AF point are displayed (p.94, 448).

I cannot lock the focus and recompose the shot.

- Set the AF operation to One-Shot AF (p.88). Note that focus lock will not work in the AI Servo AF mode (p.89).

The continuous shooting speed is slow.

- The continuous shooting speed for high-speed continuous shooting may become slower depending on the power source type, battery level, temperature, ISO speed, flicker reduction, shutter speed, aperture, subject conditions, brightness, lens, flash use, and shooting function settings. For details, see pages 148, 149.

The maximum burst during continuous shooting is lower.

- If you shoot something that has fine detail such as a field of grass, the file size will be larger, and the actual maximum burst may be lower than the number listed on page 158.
- If [**Rec. separately**] is set and different image sizes are set for the CF card (Card1) and CFast card (Card2), the maximum burst for continuous shooting will decrease.

Even after I change the card, the maximum burst displayed for continuous shooting does not change.

- The maximum burst displayed in the viewfinder does not change when you change the card, even if it is a high-speed card. The maximum burst shown in the table on page 158 is based on Canon's testing card. (The faster the card's writing speed, the higher the actual maximum burst will be.) Therefore, the maximum burst displayed in the viewfinder may differ from the actual maximum burst.

ISO 100 cannot be set. ISO speed expansion cannot be selected.

- If [**2: Highlight tone priority**] is set to [**Enable**], the settable ISO speed range will be ISO 200 - ISO 51200. Even if you set [**Range for stills**] to expand the setting range, you cannot select L (equivalent to ISO 50), H1 (equivalent to ISO 102400), H2 (equivalent to ISO 204800), or H3 (equivalent to ISO 409600). When [**2: Highlight tone priority**] is set to [**Disable**] (p.193), you can set ISO 100/125/160, L, or H1/H2/H3.

Even if I set a decreased exposure compensation, the image comes out bright.

- Set [**2: Auto Lighting Optimizer**] to [**Disable**] (p.189). When [**Low**], [**Standard**], or [**High**] is set, even if you set a decreased exposure compensation or flash exposure compensation, the image may come out bright.

I cannot set the exposure compensation while both manual exposure and ISO Auto are set.

- See page 237 to set the exposure compensation.
- For flash shooting, exposure compensation cannot be set.

The spot metering circle is not displayed.

- If [**5: Focusing screen**] is set to [**Ec-A, B, L**] (p.433), the spot metering circle will not be displayed at the viewfinder center.

The shot image is not displayed during multiple-exposure shooting.

- If [**On:ContShtng**] is set, image review immediately after image capture or image playback is not possible during shooting (p.248).

The multiple-exposure image is shot in **RAW** quality.

- When the image size is set to **M RAW** or **S RAW**, the multiple-exposure image will be recorded in **RAW** quality (p.255).

When I use the **<Av>** mode with flash, the shutter speed becomes slow.

- If you shoot at night when the background is dark, the shutter speed automatically becomes slow (slow-sync shooting) so that both the subject and background are properly exposed. To prevent a slow shutter speed, under [**3: External Speedlite control**], set [**Flash sync. speed in Av mode**] to [**1/250-1/60sec. auto**] or [**1/250 sec. (fixed)**] (p.264).

The flash does not fire.

- Make sure the flash (or PC sync cord) is securely attached to the camera.
- If you use a non-Canon flash unit with Live View shooting, set [**5: Silent LV shoot.**] to [**Disable**] (p.281).

The flash always fires at full output.

- If you use a flash unit other than an EX-series Speedlite, the flash will always be fired at full output (p.261).
- When the flash Custom Function setting for **[Flash metering mode]** is set to **[TTL flash metering]** (autoflash), the flash will always be fired at full output (p.268).

Flash exposure compensation cannot be set.

- If flash exposure compensation is already set with the Speedlite, flash exposure compensation cannot be set with the camera. When the external Speedlite's flash exposure compensation is canceled (set to 0), flash exposure compensation can be set with the camera.



High-speed sync cannot be set in the <Av> mode.

- Under **[ 3: External Speedlite control]**, set **[Flash sync. speed in Av mode]** to **[Auto]** (p.264).

The shutter makes two release sounds during Live View shooting.

- If you use flash, the shutter will make two release sounds each time you shoot (p.274).

During Live View shooting, a white or red icon is displayed.

- It indicates that the camera's internal temperature is high. If the white  icon is displayed, the still photo's image quality may deteriorate. If the red  icon is displayed, it indicates that the Live View shooting will soon stop automatically (p.293).



Shot images are not displayed when continuous shooting is performed during Live View shooting.

- If the image size is set to **M RAW** or **S RAW**, the shooting images are not displayed during continuous shooting (p.273).

During movie shooting, the red icon is displayed.

- It indicates that the camera's internal temperature is high. If the red  icon is displayed, it indicates that the movie shooting will soon stop automatically (p.341).



Movie shooting stops by itself.

- If the card's writing speed is slow, movie shooting may stop automatically. For cards that can record movies, see page 316. To find out the card's writing speed, refer to the card manufacturer's website.
- If you shoot a movie for 29 min. 59 sec. or shoot a High Frame Rate movie for 7 min. 29 sec., the movie shooting will stop automatically.
- If you shoot with , use a CFast card []. Even a high-speed CF card [] can only record a very short movie (approx. 10 sec. max.).

The ISO speed cannot be set for movie shooting.

- If the shooting mode is **<P>**, **<Tv>**, **<Av>**, or **<bulb>**, the ISO speed will be set automatically. In the **<M>** mode, you can freely set the ISO speed (p.302).

ISO 100 cannot be set or ISO speed expansion cannot be selected during movie shooting.

- If [ 2: Highlight tone priority] has been set to [Enable], the settable ISO speed range will start from ISO 200. Even if you set [Range for movies] for ISO speed expansion, you cannot select H, H1, or H2. When [ 2: Highlight tone priority] is set to [Disable] (p.193), ISO 100/125/160 or an expanded ISO speed can be set.

The manually set ISO speed changes when switching to movie shooting.

- ISO speed will be set according to the setting of [Range for stills] for [📷2:ISO speed settings] (p.166) during viewfinder shooting and Live View shooting, or the setting of [Range for movies] and [Range for 4K] (p.330) during movie shooting.

The exposure changes during movie shooting.

- If you change the shutter speed or aperture during movie shooting, the changes in the exposure may be recorded.
- Shooting a few test movies is recommended if you intend to perform zooming during movie shooting. Zooming during movie shooting may result in recoding images with changes in exposure or operation sound, or images may be out of focus.

The image flickers or horizontal stripes appear during movie shooting.

- Flickering, horizontal stripes (noise), or irregular exposures can be caused by fluorescent lighting, LED lighting, or other light sources during movie shooting. Also, changes in the exposure (brightness) or color tone may be recorded. In the <Tv> or <M> mode, a slow shutter speed may reduce the problem.

The subject looks distorted during movie shooting.

- If you move the camera to the left or right (panning) or shoot a moving subject, the image may look distorted.

The movie does not record the sound.

- High Frame Rate movies do not record sound.

The time code is not appended.

- For High Frame Rate movie shooting, if **[Free run]** is set for **[Count up]** under **[CAMERA 5: Time code]** (p.326), the time code will not be appended. Also, if there is HDMI output, the time code will not be appended to the HDMI video output (p.328).

The time code's count is faster.

- For High Frame Rate movie shooting, it will count up by 4 sec. for every sec. in real time (p.318).



I cannot take still photos during movie shooting.

- Still photos cannot be taken during movie shooting. To take still photos, stop the movie shooting and then perform viewfinder shooting or Live View shooting.

Operation Problems

I cannot change the setting with the <>, <>, or <>.

- Set the power switch to <ON> (p.53).
- Check the [ 6: Multi function lock] setting (p.437).

Vertical-grip controls like the <> and <> do not work.

- Set the vertical-grip operation switch to <ON> (p.67).

Touchscreen operation is not possible.

- Touchscreen operation cannot be performed on the menu screen and image playback screen. For Live View shooting and movie shooting, touchscreen operation can be performed to select AF points and to magnify the image.

A camera button or dial does not work as expected.

- Check the [ 6: Custom Controls] setting (p.443).

Display Problems

The display starts with [★] My Menu or the [★] tab alone is displayed.

- Under the [★] tab, [Menu display] is set to [Display from My Menu tab] or [Display only My Menu tab]. Set [Normal display] (p.467).

The file name's first character is an underscore (“_”).

- Set the color space to sRGB. If Adobe RGB is set, the first character will be an underscore (p.200).

The fourth character in the file name changes.

- [**Y1: File name**] is set to [***** + image size**]. Select the camera's unique file name (preset code) or the file name registered under User setting 1 (p.203).

The file numbering does not start from 0001.

- If the card already contains recorded images, the image file number may not start from 0001 (p.206).

The shooting date and time displayed is incorrect.

- Make sure the correct date and time are set (p.55).
- Check the time zone and daylight saving time (p.56, 57).

The date and time are not in the image.

- The shooting date and time do not appear in the image. The date and time are recorded in the image data as shooting information. When printing at a photofinisher, you can imprint the date and time in the picture, using the date and time recorded in the shooting information (p.413).

[###] is displayed.

- If the number of images recorded on the card exceeds the number the camera can display, [###] will be displayed.

The LCD monitor does not display a clear image.

- If the LCD monitor is dirty, use a soft cloth to clean it.
- The LCD monitor display may seem slightly slow in low temperatures, or look black in high temperatures. It will return to normal at room temperature.

Playback Problems

Part of the image blinks in black.

- [▶3: Highlight alert] is set to [Enable] (p.350).

A red box is displayed on the image.

- [▶3: AF point disp.] is set to [Enable] (p.351).

During image playback, the AF points are not displayed.

- When you play back an image applied with distortion correction (p.195), the AF points are not displayed.

The image cannot be erased.

- If the image is protected, it cannot be erased (p.358).

The movie cannot be copied.

- Copying movie files exceeding 4 GB may not work. For details, see page 382.

Still photos and movies cannot be played back.

- The camera may not be able to play back images taken with another camera.
- Movies edited with a computer cannot be played back with the camera.

Operation sound and mechanical sound can be heard during movie playback.

- If you operate the camera's dials or lens during movie shooting, the operation sound will also be recorded. Using an external microphone (commercially-available) is recommended (p.323).

The movie appears to freeze momentarily.

- If there is a drastic change in the exposure level during autoexposure movie shooting, the recording will stop momentarily until the brightness stabilizes. In such a case, shoot in the <M> mode (p.301).

The movie plays in slow motion.

- Since the High Frame Rate movie will be recorded as a 29.97 fps/25.00 fps movie file, it will play back in slow motion at 1/4 speed.

No picture on the TV set.

- Make sure the [**3: Video system**] is correctly set to [**For NTSC**] or [**For PAL**] (depending on the video system of your TV set).
- Make sure the HDMI cable's plug is inserted all the way in (p.379).

There are multiple movie files for a single movie shoot.

- If the movie file size reaches 4 GB, another movie file will be created automatically (p.320). However, if you use a CF card exceeding 128 GB or a CFast card formatted with the camera, you can record a movie to a single file even exceeding 4 GB.

I cannot grab frames from a movie.

- You can grab frames only from 4K movies. Frame grabbing is not possible with Full HD movies or 4K movies shot with a different camera model.

My card reader does not recognize the card.

- Depending on your card reader and computer OS, large-capacity CF cards and CFast cards may not be properly recognized. In such a case, connect your camera to the computer with the interface cable, then transfer the images to the computer using EOS Utility (EOS software, p.550).

I cannot process the RAW image.

- **M RAW** and **S RAW** images cannot be processed with the camera. Use Digital Photo Professional (EOS software, p.550) to process those images.

I cannot resize or crop the image.

- With this camera, you cannot resize JPEG **S** images or **RAW/M RAW/S RAW** images, or frame-grab images from 4K movies saved as still photos (p.397).
- **RAW/M RAW/S RAW** images and frame-grab images from 4K movies saved as still photos cannot be cropped with the camera (p.399).

Dots of light appear on the image.

- White, red, blue, or other colored dots of light may appear on images if the sensor has been affected by cosmic rays, etc. By selecting [**Clean now** ] (p.402), their appearance may be suppressed.

Sensor Cleaning Problems

The shutter makes a sound during sensor cleaning.

- If you selected [**Clean now** ], the shutter will make a mechanical sound, but no picture is taken (p.402).

Automatic sensor cleaning does not work.

- If you repeatedly turn the power switch <ON> / <OFF> within a short time period, the < > icon may not be displayed (p.53).

Printing-Related Problems

Direct printing does not work.

- The camera does not have PictBridge, and direct printing is not possible.

Computer Connection Problems

I cannot transfer images to a computer.

- From the EOS Solution Disk (CD-ROM), install EOS Utility (EOS software, p.550) to your computer (p.551).
- Make sure EOS Utility's main window is displayed.

MENU System Status Display

You can check the camera's serial number, firmware version, and shutter-release cycles on the screen. You can also check the status log for past errors and cautions.

Use this to check the camera's condition. If necessary, take the camera to nearest Canon Service Center. This is to reduce camera problems.



1 Select [System status display].

- Under the [**F4**] tab, select [**System status display**], then press <SET>.

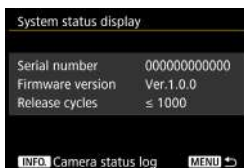

2 Check the system status.

- You can check the serial number, firmware version, and shutter-release cycles.

Check the Error and Caution Log

You can check the history of camera's past errors and cautions, and can also check the lens used, use of flash, and the battery used when the error or caution occurred.



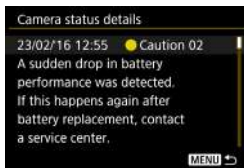

3 Check the log.

- In step 2, press the <INFO.> button.
- ▶ The camera's status log will be displayed.
- "Err ***" is an error message. For the error messages, see page 523.
- "Caution ***" is a caution message. For the caution messages, see the next page.



4 Check the system status.

- Turn the <  > dial to select an Error or Caution, then press the < INFO > button to view the message.
- Turn the <  > dial to check the message.

● Caution Messages

The camera checks its important components to see if they are operating properly. If it detects an operation that is inaccurate but not serious enough to be an error, it will be recorded as a Caution message in the Camera status log. Although you can continue shooting, follow the recommendations in the Caution message and solution since the condition may lead to a malfunction.

Caution Number	Messages	Description and Solution
01	Shutter speed repeatedly adjusted automatically. You may continue shooting but contacting a service center is recommended.	If the camera detects an error in the shutter speed, it will make adjustments to maintain shutter speed precision. If this adjustment is made repeatedly, this Caution message will appear. You can continue shooting, but consulting your nearest Canon Service Center is recommended.
02	A sudden drop in battery performance was detected. If this happens again after battery replacement, contact a service center.	While the camera is turned off, if the battery's remaining capacity decreases abnormally within a certain period, this Caution message will appear. If the same Caution message appears repeatedly even after changing to a different, fully-charged Battery Pack LP-E19 or LP-E4N/ LP-E4, there may be a problem with the camera. Consult your nearest Canon Service Center.
03	Retry operation was performed for the shutter charge mechanism. If this happens repeatedly, contacting a service center is recommended.	The shutter- and mirror-cocking operation was not completed normally. If this occurs again, this Caution message will appear. You can continue shooting, but if the same message appears again, consulting your nearest Canon Service Center is recommended.

Erasing the Camera Status Log

If you press the  button in step 3, you can delete all the log entries displayed.

- 
- The Camera status log screen displays the latest five entries for Errors and Cautions. If there are more than five entries, the oldest entries will be deleted automatically.
 - The shutter-release cycles are displayed in units of 1000. If there have been 1,000,000 or more shutter-release cycles, 1,000,000 will be displayed.
 - If the same Error or Caution occurs repeatedly, consult your nearest Canon Service Center.

Error Codes

Error number

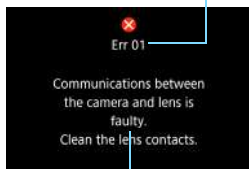

If there is a problem with the camera, an error message will appear. Follow the on-screen instructions.

Cause and countermeasures

Number	Error Message and Solution
01	<p>Communications between the camera and lens is faulty. Clean the lens contacts.</p> <p>→ Clean the electrical contacts on the camera and lens, use a Canon lens, or remove and install the battery again (p.25, 26, 47).</p>
02	<p>Card* cannot be accessed. Reinsert or replace card * or format card * with the camera.</p> <p>→ Remove and insert the card again, replace the card, or format the card (p.49, 74).</p>
04	<p>Cannot save images because card* is full. Replace card*.</p> <p>→ Replace the card, erase unnecessary images, or format the card (p.49, 386, 74).</p>
06	<p>Sensor cleaning could not be performed. Turn the camera off and on again.</p> <p>→ Operate the power switch (p.53).</p>
10, 20 30, 40 50, 60 70, 80 99	<p>An error prevented shooting. Turn the camera off and on again or re-install the battery.</p> <p>→ Operate the power switch, remove and install the battery again, or use a Canon lens (p.53, 47).</p>

* If the error still persists, write down the error code number and contact your nearest Canon Service Center.

Specifications

• Type

Type:	Digital, single-lens reflex, AF/AE camera
Recording media:	CF cards (Type I, UDMA 7 supported) CFast card (CFast 2.0 supported)
Image sensor size:	Approx. 35.9 x 23.9 mm
Compatible lenses:	Canon EF lenses * Excluding EF-S and EF-M lenses (The effective angle of view of a lens is approximately equivalent to that of the focal length indicated.)
Lens mount:	Canon EF mount

• Image Sensor

Type:	CMOS sensor
Effective pixels:	Approx. 20.2 megapixels * Rounded off to the nearest 10,000th.
Aspect ratio:	3:2
Dust delete feature:	Auto/Manual, Appending Dust Delete Data

• Recording System

Recording format:	Design rule for Camera File System (DCF) 2.0
Image type:	JPEG, RAW (14-bit Canon original), RAW+JPEG simultaneous recording possible
Pixels recorded:	L (Large) : Approx. 20.0 megapixels (5472 x 3648) M1 (Medium 1) : Approx. 12.7 megapixels (4368 x 2912) M2 (Medium 2) : Approx. 8.9 megapixels (3648 x 2432) S (Small) : Approx. 5.0 megapixels (2736 x 1824) RAW : Approx. 20.0 megapixels (5472 x 3648) M-RAW : Approx. 11.2 megapixels (4104 x 2736) S-RAW : Approx. 5.0 megapixels (2736 x 1824)
Recording function:	Standard, Auto switch card, Record separately, Record to multiple
Create/select a folder:	Possible
File name:	Preset code / User setting 1 / User setting 2
File numbering:	Continuous, Auto reset, Manual reset

• Image Processing During Shooting

Picture Style:	Auto, Standard, Portrait, Landscape, Fine Detail, Neutral, Faithful, Monochrome, User Defined 1 - 3
----------------	---

White balance:	Auto (Ambience priority), Auto (White priority), Preset (Daylight, Shade, Cloudy, Tungsten light, White fluorescent light, Flash), Custom (5 settings), Color temperature setting (approx. 2500-10000 K), Personal white balance (5 settings) White balance correction and white balance bracketing features provided * Flash color temperature information transmission possible
Automatic image brightness correction:	Auto Lighting Optimizer provided
Noise reduction:	Applicable to high ISO speed shots and long exposures
Highlight tone priority:	Provided
Lens aberration correction:	Peripheral illumination correction, Chromatic aberration correction, Distortion correction, and Diffraction correction

• Viewfinder

Type:	Eye-level pentaprism
Coverage:	Vertical/Horizontal approx. 100% (with eyepoint approx. 20 mm)
Magnification:	Approx. 0.76x (-1 m ⁻¹ with 50mm lens at infinity)
Eyepoint:	Approx. 20 mm (from eyepiece lens center at -1 m ⁻¹)
Diopric adjustment range:	Approx. -3.0 - +1.0 m ⁻¹ (dpt)
Eyepiece shutter:	Built-in
Focusing screen:	Ec-C6 provided, interchangeable
Grid display:	Provided
Electronic level:	Provided
Function setting display:	Image type: JPEG/RAW, Shooting mode, Metering mode, White balance, Drive mode, AF operation, Flicker detection, Warning ! indicator, AF status indicator
Mirror:	Quick-return type
Depth-of-field preview:	Provided

• Autofocus (during viewfinder shooting)

Type:	TTL secondary image-registration, phase-difference detection with the dedicated AF sensor
-------	---

AF points:	Max. 61 points (Cross-type AF point: Max. 41 points) * Number of available AF points, Dual cross-type AF points, and cross-type AF points vary depending on the lens used. * Dual cross-type focusing at f/2.8 with 5 AF points vertically aligned at the center. (AF group: When group A lenses are used)
Focusing brightness range:	EV -3 - 18 (Conditions: f/2.8-sensitive center AF point, One-Shot AF, room temperature, ISO 100)
Focus operation:	One-Shot AF, AI Servo AF, Manual focusing (MF)
AF area selection mode:	Single-point Spot AF (manual selection), Single-point AF (manual selection), AF point expansion (manual selection: up, down, left, and right), AF point expansion (manual selection: surround), Zone AF (manual selection of zone), Large zone AF (manual selection of zone), Automatic selection AF
AF point automatic selection conditions:	Based on EOS iTR AF setting (Enables AF incorporating human face/color information) * iTR: Intelligent Tracking and Recognition
AF Configuration Tool:	Case 1 - 6
AI Servo AF characteristics:	Tracking sensitivity, Acceleration/deceleration tracking, AF point auto switching
AF function customization:	17 functions
AF fine adjustment:	AF Microadjustment (All lenses by the same amount, Adjust by lens)
AF-assist beam:	Emitted by the EOS-dedicated external Speedlite

• Exposure Control

Metering mode:	Approx. 360,000-pixel RGB+IR metering sensor and 216-zone TTL open-aperture metering EOS iSA (Intelligent Subject Analysis) system • Evaluative metering (linked to all AF points) • Partial metering (approx. 6.2% of viewfinder at center) • Spot metering (approx. 1.5% of viewfinder at center) * Spot metering and Multi-spot metering linkable to AF point • Center-weighted average metering
Metering brightness range:	EV 0 - 20 (at room temperature, ISO 100, with evaluative metering)

Shooting mode:	Program AE, Shutter-priority AE, Aperture-priority AE, Manual exposure, Bulb exposure, Custom shooting modes (C1/C2/C3)
ISO speed (Recommended exposure index):	ISO Auto, ISO 100 - ISO 51200 manual setting (in 1/3- or whole-stop increments) and expandable to L (equivalent to ISO 50), H1 (equivalent to ISO 102400), H2 (equivalent to ISO 204800), and H3 (equivalent to ISO 409600) provided. * If highlight tone priority is set, the settable ISO speed range will be ISO 200 - ISO 51200.
ISO speed settings:	Still photo shooting range, Auto range, Auto minimum speed settable
Exposure compensation:	Manual: ± 5 stops in 1/3- or 1/2-stop increments AEB: ± 3 stops in 1/3- or 1/2-stop increments (can be combined with manual exposure compensation)
AE lock:	Auto: Applied in One-Shot AF mode with evaluative metering when focus is achieved Manual: With AE lock button
Flicker reduction:	Possible

• Multiple Exposures

Shooting method:	Function/control priority, Continuous shooting priority
Number of multiple exposures:	2 to 9 exposures
Multiple-exposure control:	Additive, Average, Bright, Dark

• Shutter

Type:	Electronically-controlled, focal-plane shutter
Shutter speed:	1/8000 sec. to 30 sec. (total shutter speed range; available range varies by shooting mode), Bulb, X-sync at 1/250 sec.

• Drive System

Drive mode:	Single, High-speed continuous, Low-speed continuous, Silent single shooting, Silent high-speed shooting, Silent low-speed shooting, 10-sec. self-timer, 2-sec. self-timer
-------------	---

Continuous shooting speed:	<p>High-speed continuous shooting</p> <p>Viewfinder shooting: Maximum approx. 14.0 fps (settable within 2 fps to 14 fps)</p> <p>Live View shooting: Maximum approx. 16.0 fps (settable within 2 fps to 14 fps and 16 fps)</p> <p>* With ISO H1 (equivalent to ISO102400) or higher (ISO 32000 or higher if the camera's internal temperature is low), the maximum continuous shooting speed during high-speed continuous shooting will be no faster than 10.0 fps during viewfinder shooting or 14.0 fps during Live View shooting (with Battery Pack LP-E19).</p> <p>* The maximum continuous shooting speed during high-speed continuous shooting may become slower depending on the power source type, battery level, temperature, ISO speed, flicker reduction, shutter speed, aperture, subject conditions, brightness, lens, flash use, shooting function settings, etc.</p> <p>* If "16 fps" is set during Live View shooting, flash will not be fired.</p> <p>Low-speed continuous shooting: Approx. 3.0 fps (settable within 1 fps to 13 fps)</p> <p>Silent high-speed continuous shooting: Approx. 5.0 fps maximum (settable within 2 fps to 5 fps)</p> <p>Silent low-speed continuous shooting: Approx. 3.0 fps maximum (settable within 1 fps to 4 fps)</p>
Max. burst:	<p>JPEG Large:</p> <p>CF card: Standard: Approx. 140 shots High speed: Full</p> <p>CFast card: Full</p> <p>RAW:</p> <p>CF card: Standard: Approx. 59 shots High speed: Approx. 73 shots</p> <p>CFast card: Approx. 170 shots</p> <p>RAW+JPEG Large:</p> <p>CF card: Standard: Approx. 48 shots High speed: Approx. 54 shots</p> <p>CFast card: Approx. 81 shots</p>

- * Based on Canon's standard testing CF card (Standard: 8 GB/High speed: UDMA mode 7, 64 GB) and CFast card (CFast 2.0, 128 GB) and the following testing conditions: Viewfinder shooting, High-speed continuous shooting, JPEG quality 8, ISO 100, and Standard Picture Style.
- * "Full" indicates that shooting is possible until the card becomes full.

• External Speedlite

Compatible Speedlites:	EX-series Speedlites
Flash metering:	E-TTL II autoflash
Flash exposure compensation:	±3 stops in 1/3- or 1/2-stop increments
FE lock:	Provided
PC terminal:	Provided
Flash control:	Flash function settings, Flash C.Fn settings

• Live View Shooting

Focus method:	Dual pixel CMOS AF
AF method:	Face+Tracking, FlexiZone - Single Manual focusing (approx. 5x and 10x magnification available for focus check) * AF possible with touchscreen operation.
Focusing brightness range:	EV -3 - 18 (at room temperature, ISO 100)
Metering mode:	Evaluative metering (315 zones), Partial metering (approx. 6.5% of Live View screen), Spot metering (approx. 2.8% of Live View screen), Center-weighted average metering
Metering brightness range:	EV 0 - 20 (at room temperature, ISO 100, with evaluative metering)
Exposure compensation:	±5 stops in 1/3- or 1/2-stop increments
Silent Live View shooting:	Provided (Mode 1 and 2)
Grid display:	3 types

• **Movie Shooting**

Recording format:	MOV, MP4
Movie:	4K: Motion JPEG Full HD: MPEG-4 AVC/H.264 Variable (average) bit rate
Audio:	MOV: Linear PCM, MP4: AAC
Movie recording size:	4K (4096x2160), Full HD (1920x1080)
Frame rate:	119.9p/59.94p/29.97p/24.00p/23.98p (with NTSC) 100.0p/50.00p/25.00p/24.00p (with PAL) * 119.9p/100.0p: Full HD quality High Frame Rate movie
Movie recording method/Compression rate:	Motion JPEG ALL-I (For editing/I-only), IPB (Standard), IPB (Light) * Motion JPEG and ALL-I available only when MOV is set. * IPB (Light) available only when MP4 is set.
Bit rate:	[MOV] 4K (59.94p/50.00p) : Approx. 800 Mbps 4K (29.97p/25.00p/24.00p/23.98p) : Approx. 500 Mbps Full HD (119.9p/100.0p)/ALL-I : Approx. 360 Mbps Full HD (59.94p/50.00p)/ALL-I : Approx. 180 Mbps Full HD (59.94p/50.00p)/IPB : Approx. 60 Mbps Full HD (29.97p/25.00p/24.00p/23.98p)/ALL-I: Approx. 90 Mbps Full HD (29.97p/25.00p/24.00p/23.98p)/IPB (Standard): Approx. 30 Mbps [MP4] Full HD (59.94p/50.00p)/IPB (Standard) : Approx. 60 Mbps Full HD (29.97p/25.00p/24.00p/23.98p)/IPB (Standard): Approx. 30 Mbps Full HD (29.97p/25.00p)/IPB (Light) : Approx. 12 Mbps 4K (59.94p/50.00p) : CFast 2.0 4K (29.97p/25.00p/24.00p/23.98p): CF UDMA 7: 100 Mbps or faster/CFast 2.0 Full HD (119.9p/100.0p): CF UDMA 7: 100 Mbps or faster/CFast 2.0 Full HD (59.94p/50.00p)/ALL-I: CF UDMA 7: 60 Mbps or faster/CFast 2.0 Full HD (59.94p/50.00p)/IPB: 30 Mbps or faster Full HD (29.97p/25.00p/24.00p/23.98p)/ALL-I: 30 Mbps or faster
Card performance requirements (Writing/reading speed):	

	Full HD (29.97p/25.00p/24.00p/23.98p)/IPB (Standard): 10 Mbps or faster
	Full HD (29.97p/25.00p)/IPB (Light) : 10 Mbps or faster
Focus method:	Dual pixel CMOS AF
AF method:	Face+Tracking, FlexiZone - Single Manual focusing (Approx. 5x and 10x magnification available for focus check)
Movie servo AF:	Possible * Movie Servo AF customizable
Focusing brightness range:	EV -3 - 18 (at room temperature, ISO 100)
Metering mode:	Center-weighted average metering and Evaluative metering with the image sensor * Automatically set by the focus method
Metering brightness range:	EV 0 - 20 (at room temperature, ISO 100, with center- weighted average metering)
Exposure control:	Autoexposure shooting (Program AE for movie shooting), Shutter-priority AE, Aperture-priority AE, Manual exposure
Exposure compensation:	±3 stops in 1/3- or 1/2-stop increments
ISO speed (Recommended exposure index):	[Full HD] P/Tv/Av/B: Automatically set within ISO 100 - ISO 25600, expandable to H (equivalent to ISO 32000/40000/51200), H1 (equivalent to ISO 102400), H2 (equivalent to ISO 204800) M: ISO Auto (automatically set within ISO 100 - ISO 25600), ISO 100 - ISO 25600 set manually (in 1/3- or whole-stop increments), expandable to H (equivalent to ISO 32000/40000/51200), H1 (equivalent to ISO 102400), H2 (equivalent to ISO 204800) [4K] P/Tv/Av/B: Automatically set within ISO 100 - ISO 12800, expandable to H (equivalent to ISO 16000/20000/25600/ 32000/40000/51200), H1 (equivalent to ISO 102400), H2 (equivalent to ISO 204800) M: ISO Auto (automatically set within ISO 100 - ISO 12800), ISO 100 - ISO 12800 set manually (in 1/3- or whole-stop increments), expandable to H (equivalent to ISO 16000/20000/25600/32000/40000/51200), H1 (equivalent to ISO 102400), H2 (equivalent to ISO 204800)

Specifications

ISO speed settings:	Range for movie shooting and 4K settable
Time code:	Appendable
Drop frames:	Compatible with 119.9p/59.94p/29.97p
Sound recording:	Built-in monaural microphone, external stereo microphone terminal, and line input provided Sound-recording level adjustable, wind filter provided, attenuator provided
Headphones:	Headphone terminal provided, sound volume adjustable
Grid display:	3 types
Still photo shooting:	Not possible during movie shooting.
2-image display:	LCD monitor and HDMI output can be displayed simultaneously.
HDMI output:	Image without information can be output. * Auto / 59.94i/50.00i / 59.94p/50.00p / 23.98p selectable. * When [24.00p: Enable] is set, the movie image is output at 24.00p via HDMI. * Time code appendable
Accessory mount:	Bottom equipped with positioning hole to prevent rotation.

• LCD Monitor

Type:	TFT color, liquid-crystal monitor
Monitor size and dots:	Width 3.2 in. (3:2) with approx. 1.62 million dots
Brightness adjustment:	Manual (7 levels)
Electronic level:	Provided
Interface languages:	25
Touchscreen:	Capacitive sensing * Works to move the AF point during Live View and movie shooting (AF enabled), and with magnified view.
Help display:	Possible
Camera system information:	Provided

• Playback

Image display format:	Single-image display (without shooting information), Single-image display (with basic information), Single-image display (Shooting information displayed: Detailed information, Lens/histogram, White balance, Picture Style 1, Picture Style 2, Color space/noise reduction, Lens aberration correction 1, Lens aberration correction 2, GPS information), Index display (4/9/36/100 images)
Highlight alert:	Overexposed highlights blink
AF point display:	Provided (may not be displayed depending on shooting conditions)
Grid display:	3 types
Magnified view:	Approx. 1.5x-10x, initial magnification and position settable
Image browsing method:	Single image, Jump by 10 or 100 images, By shooting date, By folder, By movies, By stills, By protected images, By rating
Image rotation:	Provided
Image protection:	Provided
Rating:	Provided
Voice memo:	Recording/Playback possible
Movie playback:	Enabled (LCD monitor, HDMI), built-in speaker provided
Start/end movie scene editing:	Possible
4K Frame Grab:	Frame Grab can be saved as JPEG image.
Slide show:	All images, By date, By folder, By movies, By stills, By protected images, By rating
Copying images:	Possible

• Post-Processing of Images

In-camera RAW image processing:	Brightness adjustment, White balance, Picture Style, Auto Lighting Optimizer, High ISO speed noise reduction, JPEG image-recording quality, Color space, Lens aberration correction (Peripheral illumination correction, Distortion correction, Digital lens optimizer, Chromatic aberration correction, Diffraction correction)
Resize:	Provided
Cropping:	Provided

• Image Transfer

Transferrable files: Still photos (JPEG, RAW, RAW+JPEG images), Movies

• Print Ordering

DPOF: Version 1.1 compliant

• GPS Function

Compatible satellites: GPS satellites (USA), GLONASS satellites (Russia), Quasi-Zenith Satellite System (QZSS) MICHIBIKI (Japan)

GPS signal reception modes: Mode 1, Mode 2

Geotag information appended to image: Latitude, Longitude, Elevation, Coordinated Universal Time (UTC), Satellite signal acquisition status

Position update interval: 1 sec., 5 sec., 10 sec., 15 sec., 30 sec., 1 min., 2 min., 5 min.

Time setting: GPS time data set to camera

Log data: One file per day, NMEA format

* Change in time zone creates another file.

* The log data saved in internal memory can be transferred to a card or downloaded to a computer as a log file.

Log data deletion: Possible

• Customization Features

Custom Functions: 34

Custom Quick Control: Provided

Saving camera settings: Up to ten settings can be registered on a card

Custom shooting modes: Register under C1, C2, or C3

My Menu: Up to 5 screens can be registered

Copyright information: Text entry and appending possible

• Interface

DIGITAL terminal: SuperSpeed USB (USB 3.0)
Computer communication, Connect Station CS100 connection

HDMI mini OUT terminal: Type C (Auto switching of resolution), CEC-compatible

External microphone input/Line input terminal:	3.5 mm diameter stereo mini-jack
Headphone terminal:	3.5 mm diameter stereo mini-jack
Remote control terminal:	For N3-type remote control units
System extension terminal:	Wireless File Transmitter WFT-E8/WFT-E6 connection
Ethernet terminal:	RJ-45 terminal, gigabit Ethernet compatible

• Power

Battery:	Battery Pack LP-E19/LP-E4N/LP-E4, quantity 1 * AC power usable with household power outlet accessories.
Battery information:	Power source, Battery level, Shutter count, Recharge performance indicated
Number of possible shots:	With viewfinder shooting: Approx. 1210 shots at room temperature (23°C/73°F), approx. 1020 shots at low temperatures (0°C/32°F) With Live View shooting: Approx. 260 shots at room temperature (23°C/73°F), approx. 240 shots at low temperatures (0°C/32°F) * With a fully-charged Battery Pack LP-E19.
Movie shooting time:	Total approx. 2 hr. 20 min. at room temperature (23°C/73°F) Total approx. 2 hr. at low temperatures (0°C/32°F) * With a fully-charged Battery Pack LP-E19, Movie Servo AF disabled, and Full HD 29.97p/25.00p/24.00p/23.98p IPB (Standard).

• Dimensions and Weight

Dimensions (W x H x D):	Approx. 158.0 x 167.6 x 82.6 mm / 6.22 x 6.60 x 3.25 in.
Weight:	Approx. 1530 g / 53.97 oz. (Based on CIPA Guidelines), Approx. 1340 g / 47.27 oz. (Body only)

• Operation Environment

Working temperature range:	0°C - 45°C / 32°F - 113°F
Working humidity:	85% or less

• Battery Pack LP-E19

Type:	Rechargeable lithium-ion battery
Rated voltage:	10.8 V DC
Battery capacity:	2700 mAh
Working temperature range:	During recharging: 5°C - 40°C / 41°F - 104°F During shooting: 0°C - 45°C / 32°F - 113°F
Working humidity:	85% or less
Dimensions (W x H x D):	Approx. 68.45 x 34.2 x 92.8 mm / 2.69 x 1.35 x 3.65 in.
Weight:	Approx. 185 g / 6.53 oz. (excluding protective cover)

• Battery Charger LC-E19

Compatible battery packs:	Battery Pack LP-E19/LP-E4N/LP-E4
Recharge time (at room temperature):	LP-E19: Approx. 2 hr. 50 min. per battery LP-E4N/LP-E4: Approx. 2 hr. 20 min. per battery
Rated input:	100 - 240 V AC (50/60 Hz)
Rated output:	12.6 V DC, 1.63 A
Power cord:	Approx. 2.0 m / 6.6 ft.
Working temperature range:	5°C - 40°C / 41°F - 104°F
Working humidity:	85% or less
Dimensions (W x H x D):	Approx. 155.0 x 51.0 x 95.0 mm / 6.10 x 2.01 x 3.74 in.
Weight:	Approx. 335 g / 11.82 oz. (excluding power cord and protective covers)

- All the data above is based on Canon's testing standards and CIPA (Camera & Imaging Products Association) testing standards and guidelines.
- Dimensions and weight listed above are based on CIPA Guidelines (except weight for camera body only).
- Product specifications and the exterior are subject to change without notice.
- If a problem occurs with a non-Canon lens attached to the camera, consult the respective lens manufacturer.

Trademarks

- Adobe is a trademark of Adobe Systems Incorporated.
- Microsoft and Windows are trademarks or registered trademarks of Microsoft Corporation in the United States and/or other countries.
- Macintosh and Mac OS are trademarks of Apple Inc., registered in the U.S. and other countries.
- Canon is an authorized licensee of the CFast 2.0™ trademark, which may be registered in various jurisdictions.
- CompactFlash is a trademark of SanDisk Corporation.
- HDMI, HDMI logo, and High-Definition Multimedia Interface are trademarks or registered trademarks of HDMI Licensing LLC.
- All other trademarks are the property of their respective owners.

About MPEG-4 Licensing

"This product is licensed under AT&T patents for the MPEG-4 standard and may be used for encoding MPEG-4 compliant video and/or decoding MPEG-4 compliant video that was encoded only (1) for a personal and non-commercial purpose or (2) by a video provider licensed under the AT&T patents to provide MPEG-4 compliant video. No license is granted or implied for any other use for MPEG-4 standard."

* Notice displayed in English as required.

Use of Genuine Canon Accessories Is Recommended

This product is designed to achieve excellent performance when used with genuine Canon accessories.

Canon shall not be liable for any damage to this product and/or accidents such as fire, etc., caused by the malfunction of non-genuine Canon accessories (e.g., a leakage and/or explosion of a battery pack). Please note that this warranty does not apply to repairs arising out of the malfunction of non-genuine Canon accessories, although you may request such repairs on a chargeable basis.

-  Battery Pack LP-E19 and LP-E4N/LP-E4 are dedicated to Canon products only. Using it with an incompatible battery charger or product may result in malfunction or accidents for which Canon cannot be held liable.



Only for European Union and EEA (Norway, Iceland and Liechtenstein)

These symbols indicate that this product is not to be disposed of with your household waste, according to the WEEE Directive (2012/19/EU), the Battery Directive (2006/66/EC) and/or national legislation implementing those Directives.

If a chemical symbol is printed beneath the symbol shown above, in accordance with the Battery

Directive, this indicates that a heavy metal (Hg = Mercury, Cd = Cadmium, Pb = Lead) is present in this battery or accumulator at a concentration above an applicable threshold specified in the Battery Directive.

This product should be handed over to a designated collection point, e.g., on an authorized one-for-one basis when you buy a new similar product or to an authorized collection site for recycling waste electrical and electronic equipment (EEE) and batteries and accumulators. Improper handling of this type of waste could have a possible impact on the environment and human health due to potentially hazardous substances that are generally associated with EEE. Your cooperation in the correct disposal of this product will contribute to the effective usage of natural resources.

For more information about the recycling of this product, please contact your local city office, waste authority, approved scheme or your household waste disposal service or visit www.canon-europe.com/weee, or www.canon-europe.com/battery.

CAUTION

RISK OF EXPLOSION IF BATTERY IS REPLACED BY AN INCORRECT TYPE.
DISPOSE OF USED BATTERIES ACCORDING TO LOCAL REGULATION.



















15

Software Overview

Software Overview



EOS Solution Disk

Various software for EOS cameras is contained on the EOS Solution Disk.

(Software Instruction Manuals are not contained on the EOS Solution Disk.)

EOS Utility

With the camera connected to a computer, EOS Utility enables you to transfer still photos and movies shot with the camera to the computer. You can also use this software to set various camera settings and shoot remotely from the computer connected to the camera.

Digital Photo Professional

This software is recommended for users who shoot RAW images. You can view, edit, and print RAW and JPEG images.

* Some functions differ between the version to be installed on a 64-bit computer and that to be installed on a 32-bit computer.

Picture Style Editor

You can edit Picture Styles, and create and save original Picture Style files. This software is aimed at advanced users who are experienced in image processing.

Map Utility

Shooting locations can be displayed on a map on a computer screen by using the geotag location information recorded. Note that Internet connection is required to install and use Map Utility.

● Downloading from the Canon website

You can download the following software and Software Instruction Manuals from the Canon website.

www.canon.com/icpd

EOS MOVIE Utility

This software enables you to play back the movies you shot, consecutively play back movie files that were split up, and merge the split movie files and save it as a single file. You can also grab movie frames and save them as still photos.

Installing the Software



- **Do not connect the camera to a computer before you install the software. The software will not be installed correctly.**
- If there is a previous version of the software already installed on the computer, follow the procedure below to install the latest version. (The previous version will be overwritten.)

- 1 Insert the EOS Solution Disk into the computer.**
 - For Macintosh, double-click to open the CD-ROM icon displayed on the desktop, then double-click on **[setup]**.
- 2 Click [Easy Installation] and follow the on-screen instructions to install.**
- 3 After the software is installed, remove the CD-ROM.**



Index

Numerics

10- or 2-sec. self-timer.....	150
4, 9, 36, or 100 images.....	352
4K 4096x2160 (movie).....	312

A

AC adapter.....	483
Acceleration/deceleration tracking.....	119
Access lamp.....	51, 52
Accessories.....	3
Adjust all by same amount (AF)....	138
Adobe RGB.....	200
AE lock.....	245
AE Microadjustment.....	429
AEB (Auto Exposure Bracketing).....	243, 422
AF.....	87
AF area selection mode .	91, 93, 96
AF-assist beam.....	125
AF Configuration Tool.....	113
AF groups.....	102
AF method.....	284, 333
AF Microadjustment.....	138
AF operation.....	88
AF operation indicator.....	90
AF point brightness.....	136
AF point selection.....	94, 451
AF sensor.....	100
Area AF frame.....	92, 98
Beeper.....	76
Color information.....	127
Cross-type focusing.....	100
Customization.....	122
Difficult subjects for AF.....	144, 289
Direct selection of AF point.....	451

Dual cross-type focusing.....	100
f/8 AF.....	100
Facial information.....	127
Focusing point (AF point) auto switching.....	120
Manual focusing (MF).....	145, 291
Number of AF points.....	102
Out of focus.....	61, 62, 506
Recomposing.....	245
Registering and using an AF point.....	448
Spot AF point.....	30, 96
AF point expansion Manual selection 	91, 96
Manual selection, surrounding points.....	92, 97
AF-ON (AF start) button.....	62, 444, 446
AI SERVO (AI Servo AF).....	90
Acceleration/deceleration tracking.....	119
AF point auto switching.....	120
Initial position.....	134
Tracking sensitivity.....	118
ALL-I (For editing/I-only).....	315
Ambience priority (AWB).....	179
Anti-flicker shooting.....	198
Aperture-priority AE.....	233, 298
Area AF frame.....	92, 98
Attenuator.....	323
Auto ().....	169
Auto Lighting Optimizer.....	189
Auto playback.....	376
Auto power off.....	53, 76
Auto reset.....	207
Auto rotate vertical images.....	390
Auto switch card.....	153

- Auto time setting (GPS)221
 - Autofocus → AF
 - Automatic selection (AF).....92, 98
 - Av (Aperture-priority AE).....233, 298
- B**
- B/W170, 174
 - Basic information display346
 - Battery → Power
 - Beep (Beeper).....76
 - Bit rate.....530
 - Black-and-white images.....170, 174
 - Bracketing
 - AEB (Auto exposure bracketing).....243, 422
 - FEB (Flash exposure bracketing).....267
 - White balance bracketing187, 422
 - bulb (Bulb exposures).....246, 296
 - buSY (BUSY).....161, 192
- C**
- C1/C2/C3 (Custom Shooting)472
 - Cable protector38
 - Calibration (battery)45, 46
 - Camera
 - Camera shake61, 229
 - Camera vibration blurr229, 256
 - Clearing the camera settings.....77
 - Holding the camera61
 - Saving/loading camera settings468
 - Settings display479
 - System status520
 - Caption (name)184
 - Cards5, 25, 49, 74, 316
 - Card reminder50
 - Formatting74
 - Requirements.....316
 - Troubleshooting52, 75
 - Cases (AI Servo AF)113
 - Caution log/status.....520, 521
 - Center-weighted average metering239
 - CF card → Cards
 - CFast card → Cards
 - Charger36, 42
 - Chromatic aberration correction ...195
 - Cleaning (image sensor)401
 - Clearing the camera settings.....77
 - AI Servo AF characteristics.....121
 - Camera function settings77
 - Custom Controls443
 - Custom Functions420
 - Custom Quick Control.....461
 - Flash function settings268
 - My Menu466
 - Clipped highlights350
 - CLn.....405
 - Color space200
 - Color temperature177, 185
 - Color tone.....173
 - Compression rate (JPEG quality)162
 - Continuous (file numbering)206
 - Continuous shooting.....146
 - Contrast.....173, 189
 - Copyright information208
 - Cropping399
 - Cropping information439
 - Cross-type focusing.....100
 - Custom Controls.....443

Custom Functions 418, 421
 Custom Quick Control 459
 Custom shooting modes 472
 Custom white balance 180

D

D+ 193
 Date/time 55
 Daylight saving time 57
 DC Coupler 483
 Default settings tables .. 77, 78, 79, 80
 Depth-of-field preview 235
 Dials

 Main Dial 63
 Quick Control Dial 64



Diffraction correction 196
 Digital Lens Optimizer 395
 Digital terminal 28, 38, 408
 Dioptic adjustment 61
 Direct selection (AF point) 451
 Distortion correction 195
 DPOF
 (Digital Print Order Format) 413
 Drive mode 146
 Dual cross-type focusing 100
 Dust Delete Data 403

E

Electronic level 82, 83
 Erasing images 386
 Err (error codes) 523
 Error log 520
 Ethernet → Wired LAN Instructions
 Evaluative metering 238
 exFAT 75, 320
 Expanded ISO speed 163, 166

Exposure compensation 241
 Exposure compensation
 with ISO Auto 237
 Exposure level increments 421
 Exposure level
 indicator 31, 33, 275, 305
 Exposure maintained for
 new aperture 425
 Exposure simulation 281
 External Speedlite → Flash
 Eyecup 61
 Eyepiece shutter 258

F

FHD 1920x1080 (movie) 312
 Faithful () 170
 FAT32 75, 320
 FE lock 260
 FE Microadjustment 430
 File extension 205
 File name 203
 Underscore “_” 200, 205
 File size 158, 319, 347
 Filter effect (Monochrome) 174
 Final image simulation 277, 308
 Fine Detail () 170
 Fineness (Sharpness) 173
 Firmware 498
 First-curtain synchronization 267
 Flash (Speedlite) 259
 Custom Functions 268
 External flash units 260
 FE lock 260
 Flash control
 (function settings) 263

Flash exposure bracketing
(FEB)267

Flash exposure
compensation260, 267

Flash mode265

Flash sync contacts27

Flash sync speed.....261, 264

Manual flash265

Shutter synchronization
(1st/2nd curtain).....267

Wireless.....266

Flash exposure bracketing (FEB) .267

Flash sync. speed in Av mode264

Focus indicator.....89

Focus lock.....89

Focus mode switch6, 59, 145, 291

Focusing → AF

Focusing area
(AF area selection mode)....91, 93, 96

Focusing point
(AF point).....91, 94, 96, 100

Focusing screen.....433

Folder creation/selection.....201, 202

For editing (ALL-I).....315

Formatting (card initialization).....74

Frame Grab.....374

Frame rate312, 340

Free run326

Full High-Definition (Full HD)
(movie).....295, 312

Functions available by shooting
mode.....486

G

GPS220

Geotag update interval220

Grid81, 280, 333, 345

H

H/H1/H2/H3
(expanded) 163, 166, 330

HDMI 38, 367, 379

Connected indicator 338

HDMI CEC 380

Output 338, 340

Time code 328

Headphones 324

Help 85

High Frame Rate 318

High ISO speed noise reduction... 190

Highlight alert 350

Highlight tone priority..... 193

High-speed continuous
shooting..... 146, 148, 431

Histogram 275, 305, 351

Hot shoe 27, 260

Household power 483

I

ICC profile 200

Icons 8

Illumination (LCD panel)..... 67

Image dust prevention..... 401

Image review time 77

Image-recording quality..... 155, 311

Image size..... 155, 312

JPEG quality 162

Images

AF point display 351

Auto playback 376



Auto reset..... 207



Auto rotation..... 390

Continuous (file numbering)..... 206

Copying..... 382

- Erasing 386
- Highlight alert 350
- Histogram 351
- File numbering 206
- Index display 352
- Jump display (image browsing) 353
- Magnified view 355
- Manual reset 207
- Manual rotation 357
- Playback 343
- Protecting images 358
- Rating 361
- Shooting information 347
- Size 155, 158, 312
- Slide show 376
- Transfer 408
- Viewing on a TV set 367, 379
- Voice memo 363
- Index display 352
- INFO. button ... 67, 275, 305, 344, 478
- Initial AF Point 134
- Initial magnification ratio/position .. 356
- IPB (Light) 315
- IPB (Standard) 315
- ISO speed 163, 299, 302
- 4k range 330
- Auto range 167
- Automatic setting (Auto) 165
- ISO expansion 166
- Manual setting range 166
- Minimum speed for auto 168
- Movie shooting range 330
- Setting increments 421
- Still image shooting range 166
- iTR AF 127
- J**
- JPEG 155, 158
- Jump display 353
- L**
- LAN → Wired LAN Instruction Manual
- Landscape () 170
- Language 58
- Large (image size) 155, 158, 397
- Large Zone AF 92, 98
- LCD monitor 24
- Brightness adjustment 389
- Electronic level 82, 478
- Image Playback 343
- Menu display 71, 490
- Quick Control 68, 480
- LCD Panel
- Illumination 67
- Rear 34
- Top 32
- Lens 25, 59
- Aberration correction 194
- AF group designations 102
- Chromatic aberration
- correction 195
- Diffraction correction 196
- Digital Lens Optimizer 395
- Distortion correction 195
- Focus mode
- switch 6, 59, 145, 291
- Lock release 60
- Peripheral illumination
- correction 194
- Light (IPB) 315
- Line input 322
- Live View Shooting 271
- Exposure simulation 281

- Face+Tracking285
 - FlexiZone - Single.....287
 - Grid display.....280
 - Information display275
 - Manual focusing (MF).....291
 - Metering timer.....283
 - Possible shots273
 - Quick Control.....279
 - Silent LV shooting.....281
 - LOCK66, 437
 - LOG221
 - Logging222
 - Log Data223
 - Long exposure noise reduction.....191
 - Long exposures (Bulb).....246
 - Low-speed continuous shooting146, 431
 - LV → Live View shooting
- M**
- M (Manual exposure).....236, 301
 - Magnified view290, 291, 355
 - Main Dial.....63
 - Malfunction.....502
 - Manual exposure236, 301
 - Manual focusing (MF)145, 291
 - Manual reset207
 - Manual selection
 - (AF point).....91, 94, 96
 - Maximum burst158, 161
 - Medium (image size).....155, 158, 397
 - Memory cards → Cards
 - Menu.....71
 - Dimmed menu items.....73
 - My Menu.....463
 - Setting procedure72
 - Settings.....490
 - MENU** icon.....8
 - Metered manual flash.....262
 - Metering mode238
 - Metering timer62, 283, 336
 - M-Fn93, 132, 445, 447
 - M-Fn2445, 447
 - Microadjustment.....138, 429, 430
 - Microphone
 - Built-in296
 - External.....323
 - Voice memo363
 - Mirror lockup.....256
 - Monochrome ().....170
 - Motion JPEG ().....315
 - MOV311
 - Movies295
 - 24.00p317
 - AE lock.....300
 - AF method310, 333
 - AF speed during Movie Servo
 - AF334
 - Aperture-priority AE298
 - Attenuator323
 - Autoexposure shooting296
 - Compression method.....315
 - Drop frame329
 - Editing out first and last scenes.....372
 - Enjoying movies.....367
 - External microphone323
 - File size.....319, 320
 - Frame Grab.....374
 - Frame rate312, 340
 - Free run326
 - Grid display333
 - HDMI output.....338, 340
 - Headphones.....324

- High Frame Rate 318
 Information display 305
 Line input 322
 Manual exposure shooting 301
 Metering timer 336
 Microphone 296, 323
 MOV/MP4 311
 Movie recording method 315
 Movie Servo AF tracking
 sensitivity 335
 Movie shooting button 296, 337
 Playback 367, 369
 Playback count 327
 Quick Control 310
 Rec run 326
 Record command 328
 Recording quality (size) 312
 Recording time 319
 Recording/playback count 327
 Servo AF 331
 Shutter speed 297, 301, 304
 Shutter-priority AE 297
 Silent control 325
 Sound Recording/
 Sound-Recording Level 322
 Time code 326
 Viewing on a TV set 367, 379
 Wind filter 323
- MP4 311
- M-RAW
 (Medium RAW) 155, 158, 160
 Multi-controller 65
 Multi function 93, 132, 445, 447
 Multi function 2 445, 447
 Multi function lock 66, 437
 Multi-spot metering 240
 Multiple exposure 248
- My Menu 463
- ## N
- Neutral () 170
 Noise reduction
 High ISO speed 190
 Long exposures 191
 Nomenclature 26
 Non-Canon flash units 261
 NTSC 312, 379, 497
- ## O
- ONE SHOT (One-Shot AF) 89
 One-touch image quality
 setting 161, 455
- ## P
- P (Program AE) 228, 296
 PAL 312, 379, 497
 Partial metering 238
 PC terminal 261
 Peripheral illumination correction . 194
 Personal white balance 178
 Picture Style 169, 172, 175
 Pixel count 156, 158
 Playback 343
 Portrait () 169
 Possible recording time
 (movie) 307, 319
 Possible shots 54, 158, 273
 Power 53
 Auto power off 53, 76
 Battery information 482
 Battery level 54, 482
 Calibration 45, 46
 Charging 42
 Household power 483

Possible shots54, 158, 273
 Recharge performance.....482
 Pressing completely.....62
 Pressing halfway.....62
 Print order (DPOF).....413
 Program AE228, 296
 Program shift229
 Protecting images358

Q

 (Quick Control) ..68, 279, 310, 365
 Quick Control Dial64

R

Rating mark.....361
 RAW.....155, 158, 160
 RAW image processing392
 RAW+JPEG155, 158
 Rear LCD panel34
 Rec run326
 Rec. separately153
 Recharging.....42
 Record function.....152
 Rec. to multiple153
 Reduced display352
 Release shutter without card50
 Remote control terminal.....258
 Remote switch258
 Resizing397
 Rotation (image)357, 390

S

Safety precautions20
 Safety shift424
 Saturation.....173
 Second-curtain synchronization.....267
 Self-timer.....150

Sensitivity → ISO speed
 Sensor cleaning.....401
 Sepia (Monochrome).....174
 Servo AF
 AI Servo AF.....90
 Movie Servo AF331, 334, 335
 Sharpness173
 Shooting information display347
 Shooting modes32
 Av (Aperture-priority AE) ..233, 298
 Bulb.....296
 C1/C2/C3 (Custom Shooting) ..472
 M (Manual exposure).....236, 301
 P (Program AE).....228, 296
 Tv (Shutter-priority AE)231, 297
 Shooting orientation registration...132
 Shutter button.....62
 Shutter release time lag440
 Shutter synchronization.....267
 Shutter-priority AE231, 297
 Silent shooting
 Silent HS shooting147, 431
 Silent LS shooting147, 431
 Silent LV shooting281
 Single: Silent shooting147
 Single shooting.....146
 Single-image display344
 Single-point AF.....91, 96, 287
 Single-point Spot AF.....91, 96
 Slide show376
 Small (Image size).....155, 158, 397
 Software550
 Instruction Manual.....4
 Sound recording/
 Sound-Recording Level.....322
 Speaker27, 364, 369

Specifications	524
Spot AF point	30, 96
Spot metering	239, 423
S-RAW (Small RAW)	155, 158, 160
sRGB	200
Standard (IPB)	315
Standard ()	169
Stop down aperture	235
Strap	37
Strength (Sharpness)	173
System extension terminal	28
System map	484

T

Temperature warning	293, 341
Threshold (Sharpness)	173
Time code	326
Time zone	55
Tone priority	193
Toning effect (Monochrome)	174
Top LCD panel	32
Touch control	283, 284, 336
Touch pad	66, 325
Tracking sensitivity	118
Tripod socket	26
Troubleshooting	502
Tv (Shutter-priority AE)	231, 297

U

Ultra DMA (UDMA)	50, 158
Underscore “_”	200, 205
USB (DIGITAL) terminal ...	28, 38, 408
User Def. ()	170
UTC	212

V

Vertical-grip ON/OFF switch	67
Video system	311, 379, 497
Viewfinder	
Dioptic adjustment	61
Electronic level	83
Grid	81
Information display	84
Viewing on a TV set	367, 379
Voice memo	
Playback	364
Recording	363
Volume (movie playback)	370

W

Warning icon	436
White balance (WB)	177
Auto	179
Bracketing	187
Color temperature setting	185
Correction	186
Custom	180
Personal	178
White priority (AWB)	179
Wind filter	323
Wired LAN → Wired LAN Instruction Manual	

Z

Zone AF	92, 97
---------------	--------





CANON INC.

30-2 Shimomaruko 3-chome, Ohta-ku, Tokyo 146-8501, Japan

Europe, Africa & Middle East

CANON EUROPA N.V.

PO Box 2262, 1180 EG Amstelveen, The Netherlands

For your local Canon office, please refer to your warranty card or to www.canon-europe.com/Support

The product and associated warranty are provided in European countries by Canon Europa N.V.

The descriptions in this Instruction Manual are current as of February 2016. For information on the compatibility with any products introduced after this date, contact any Canon Service Center. For the latest version Instruction Manual, refer to the Canon website.