

Foreword

Thank you for purchasing the Aputure Amaran Tri-8s!

Tri-8s is the Amaran flagship video light, with durable metal construction, ultra thin design, light and handy, also with excellent thermal management capabilities, equipped with 888 ultra-high color rendering index (CRI95 + / TLCI95 +) lamp beads, helping you keep true colors. Tri-8s has a convenient multiple power supply system, you can use battery in a location shooting, besides, AC adapter attached is for your indoor shooting. In addition, the use of OLED screen display, 2.4GHz RF technology wireless remote control, everything is for you to shoot.

Instructions

- Please read this product manual carefully.
- Keep this product manual. Always include this product manual when passing the products on to third parties.
- Heed all warnings and follow all instructions in this product manual.

WARNING: Do not place the product in a place where there are corrosive chemicals to protect the product from corrosion, corrosion may cause the product to malfunction.

- Use only a microfiber and dry cloth for cleaning the product.
- Operate carefully to not cause any damage by dropping or physical shocking it.
- Do not leave the product near anything that has a strong magnetic field such as a magnet or electric motor.
- Also avoid using or leaving the product near anything emitting strong radio waves such as a large antenna. Strong magnetic fields can cause the product to malfunction or destroy data transferring.
- Do not leave the product in excessive heat, high temperatures can cause the product to malfunction.
- To reduce the risk of fire or electric shock, do not use the product near water.

- Please have the product checked by the authorized service or agent if your product has some problems. Please note that this warranty does not apply to repair arising out of the malfunction of unauthorized disassembly, although you may request such repairs on a chargeable basis.
- Use of original Aputure cable accessories is recommended. Please note that this warranty does not apply to repairs arising out of the malfunction of non-original Aputure accessories, although you may request such repairs on a chargeable basis.
- The product is certificated by RoHS, CE, FCC and JAPAN MIC. Please operate the product in full compliance with the operation standards. Please note that this warranty does not apply to repair arising from malfunction, although you may request such repairs on a chargeable basis.
- The instructions and information in this manual are based on thorough, controlled company testing procedures. Further notices will not be given if the design and specifications change.

FCC Compliance Statement

This device complies with Part 15 of the FCC Rules. Operation is subject to the following two conditions: (1) This device may not cause harmful interference, and (2) This device must accept any interference received, including interference that may cause undesired operation.

Warning: Changes or modifications not expressly approved by the party responsible for compliance could void the user's authority to operate the equipment.

NOTE: This equipment has been tested and found to comply with the limits for a Class B digital device, pursuant to Part 15 of the FCC Rules. These limits are designed to provide reasonable protection against harmful interference in a residential installation. This equipment generates uses and can radiate radio frequency energy and, if not installed and used in accordance with the instructions, may cause harmful interference to radio communications. However, there is no guarantee that interference will not occur in a particular installation. If this equipment does cause harmful interference to radio or television reception, which can be determined by turning the equipment off and on, the user is encouraged to try to correct the interference by one or more of the following measures:

- Reorient or relocate the receiving antenna.
- Increase the separation between the equipment and receiver.
- Connect the equipment into an outlet on a circuit different from that to which the receiver is connected.
- Consult the dealer or an experienced radio/TV technician for help.

RF warning statement: The device has been evaluated to meet general RF exposure requirement. The device can be used in portable exposure condition without restriction.

Detailed product manual for Amaran Tri-8s can be found on the movie solution page on www.aputure.com.

Item check list

Package includes the following items:

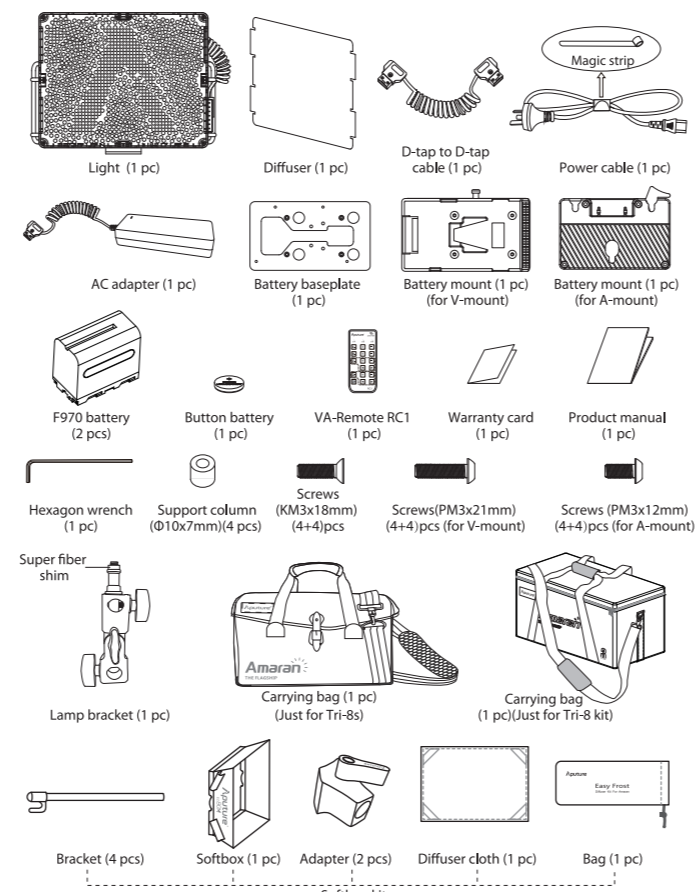

Nomenclature

1. Light

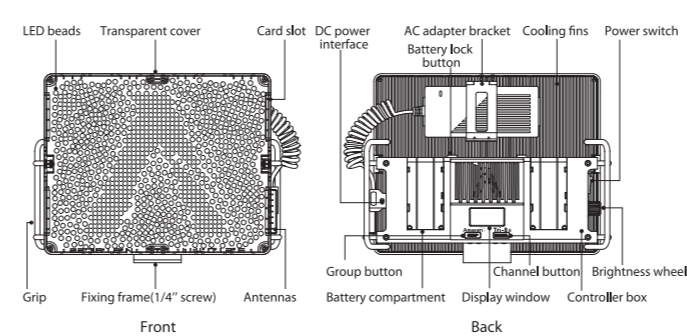

2. VA-Remote RC1

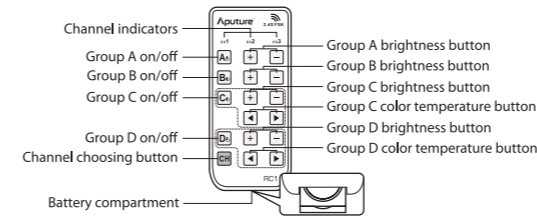

Installations

1. Install the LED light

Rotate the 3/8" ~ 1/4" screw of the lamp bracket to the 1/4" screw hole of the fixing frame; fix the lamp bracket on the lamp stand, then adjust the appropriate angle and tighten.

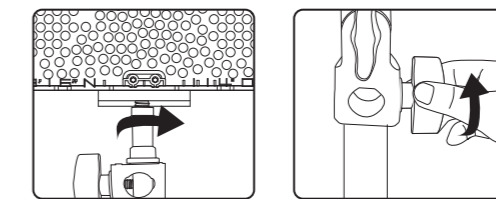

2. Power supply

1) Powered by the AC adapter

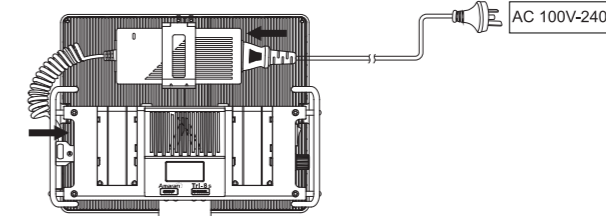

2) Powered by the Lithium batteries

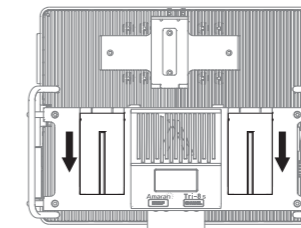

* Press the battery lock button, while pushing the battery, you can remove the battery.

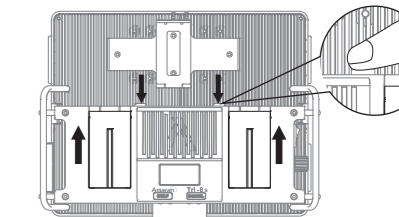

* Usable lithium batteries include Sony NP-F Series: NP-F750/F770/F960/F970; NP-FM/QM Series: FM55H/FM500H /QM50/QM51/QM71D/QM91D.

3) Powered by the V-Mount battery or Anton Bauer battery
You can supply power by connecting the light and V-mount battery or anton bauer battery with "D-tap to D-tap cable".

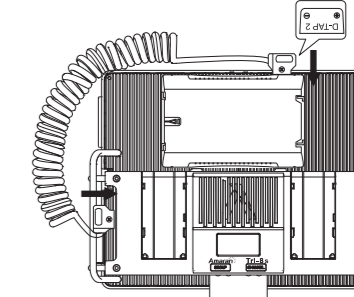

*Please choose the model of the Tri-8s by your battery need.

① Disassemble the AC adapter bracket, screws (KM3x18mm) and support column (Ø10x9mm) with the included hexagon wrench, and then save these parts.

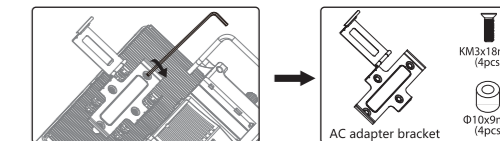

* If you need to use the AC adapter bracket again, please install back the disassembled parts in the corresponding position.

② Battery mount installation
* For V-mount

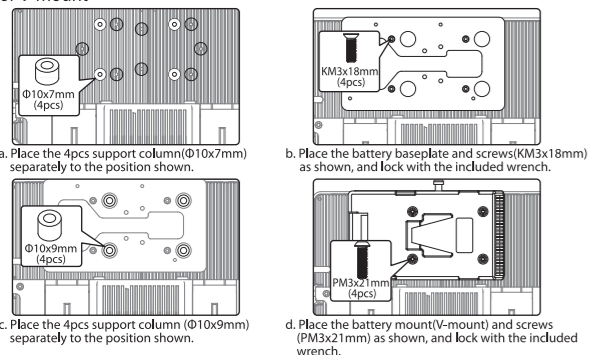

* For Anton Bauer

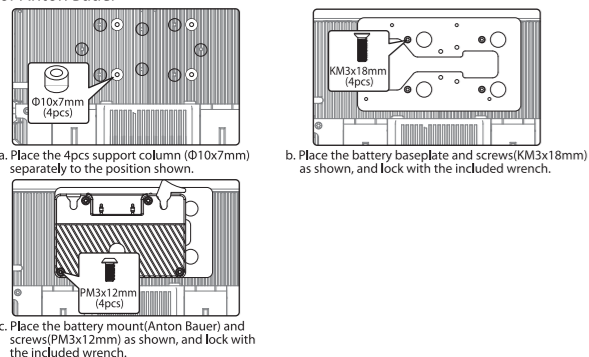

3. Install diffuser as you need

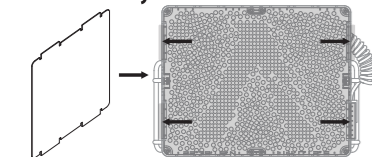

4. Insert the button battery to power VA-Remote RC1

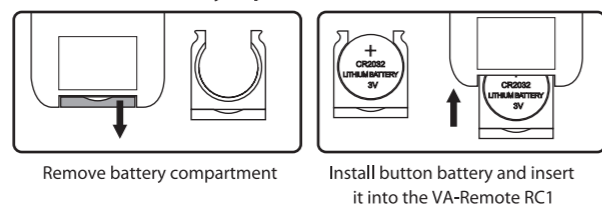

5. Softbox kit installation

Install softbox kit as you need.

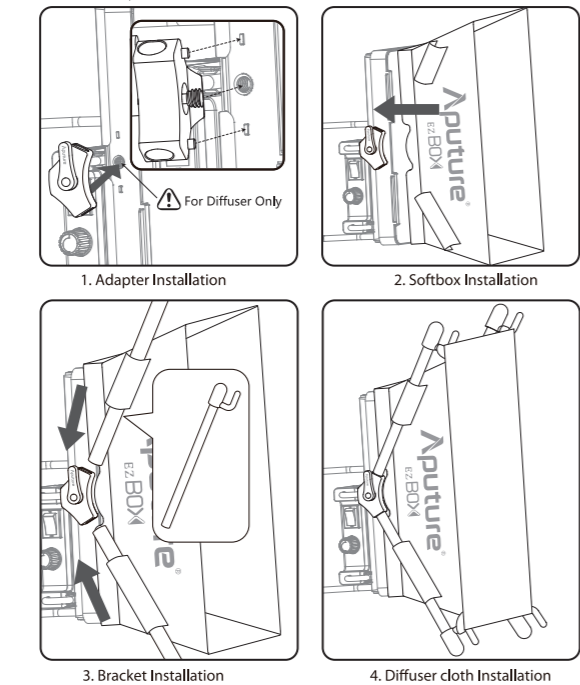

Operations

1. Press power switch to turn on the Tri-8s

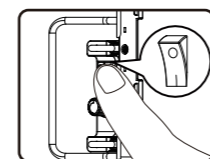

* Channel 1, Group A is by default.
* The brightness is 10% by default.

2. Manual controlled by the controller box

1) Brightness adjustment and display

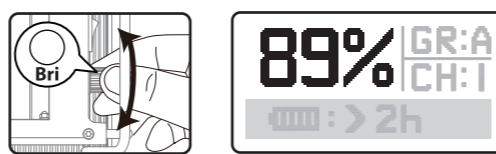

3. Remote controlled by VA-Remote RC1

For example, you can control the Tri-8s of channel 2, group C according to the following directions.

1) The controller box setting

*1) Group setting and display



*2) Channel setting and display

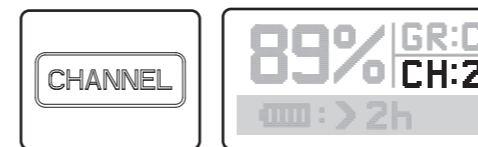

2) VA-Remote RC1 setting and display

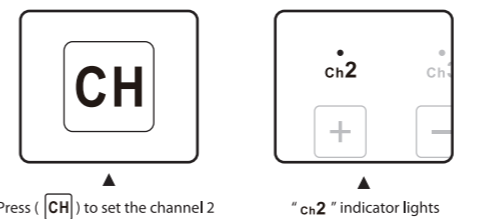

VA-Remote RC1 setting is finished.

*The Tri-8s has three channels (1/2/3) and four groups (A - B - C - D).

3) Brightness adjustment

Press (+) or (-) of group C to adjust the brightness. The brightness varies in 1%.

Brightness changes between 10% and 100%.

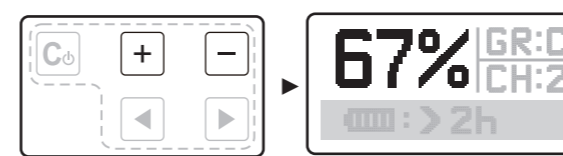

4. Battery charge

When using the AC adapter and lithium batteries at the same time, the AC adapter is priority of use to provide power, and support charging battery directly while lighting Tri-8s. Of course, for charging the battery faster, shutdown charge is recommended.



5. Battery remaining time display

Tri-8s can display the battery remaining time. When the battery remaining time less than 10 minutes, the remaining time will flash to remind you, when the battery remaining time less than 5 minutes, the LED light will also flash to remind you, please charge or replace the batteries.



Tips and trouble setting

1. Please turn off the Tri-8s before removing batteries.
2. Please do not look at the Tri-8s straightly, or it could damage your eyes.
3. Please do not keep touching the Tri-8s cooling fins long time during lighting, or it could make you injured.
4. Keep a distance of over 10 centimeters away from the Tri-8s.
5. Suggest to take out of the button battery of the VA-Remote RC1 if do not use the VA-Remote RC1 for a long period.
6. When using V-mount or Anton Bauer battery and F970 batteries at the same time, the V-mount or Anton Bauer battery is priority of use to provide power, when the V-mount or Anton Bauer battery power is low, if you want to switch to use F970 batteries, please disconnect "D-tap to D-tap cable", then restart the power switch.
7. When using V-mount or Anton Bauer battery power supply, for longer use time, it is recommended to take off the F970 batteries.

Specifications

Model	Tri-8s
Operation Current	4A
Power Supply	DC 15V
Power Input	60W
Beam Angle	25°
Color Temperature	5500K
Cooling Mode	Natural convection heat transfer
Radio Frequency	2.4GHz
Channels	1/2/3
Groups	A/B/C/D
Remote Range	≤150m
Sizes (L*W*H)	260.99*198.64*93.15mm

Brightness (average)

Model	Distance	Footcandles	LUX
Tri-8s	0.5m	2230	24000
	1m	650	7000

Trademarks

Sony is a trademark or registered trademark of Sony Corporation in the P.R.C. and other countries. All other corporate and product names and trademarks mentioned in this manual are the property of their respective owners.